



# POTENTIAL OF WIND-ASSISTED PROPULSION FOR SHIPPING

BY ABS, CE DELFT & ARCSILEA

EMSA/Wind- 2022/2023 - 4837444

Date: 31/08/2023

### About this study:

This report was commissioned by the European Maritime Safety Agency (EMSA) under framework contract EMSA/OP/43/2020

### Authors:

Laursen, R.; Patel, H.; Sofiadi, D.; Zhu, R.; Nelissen, D.; Van Seters, D.; Pang, E., (2023). (American Bureau of Shipping, CE Delft and Arcsilea)

### Recommended citation:

#### Recommended Citation

European Maritime Safety Agency (2023), *Potential of Wind-Assisted Propulsion for Shipping*, EMSA, Lisbon

### Legal notice:

Neither the European Maritime Safety Agency (EMSA) nor any third party acting on behalf of the Agency is responsible for the use that may be made of the information contained in this report.

### Copyright notice<sup>1</sup>:

The contents of this report may be reproduced, adapted and/or distributed, totally or in part, irrespective of the means and/or the formats used, provided that EMSA is always acknowledged as the original source of the material. Such acknowledgement must be included in each copy of the material.

Citations may be made from such material without prior permission, provided the source is always acknowledged.

The above-mentioned permissions do not apply to elements within this report where the copyright lies with a third party. In such cases, permission for reproduction must be obtained from the copyright holder.

This report and any associated materials are available online at [www.emsa.europa.eu](http://www.emsa.europa.eu)

© European Maritime Safety Agency 2023

---

<sup>1</sup> The copyright of EMSA is compatible with the CC BY 4.0 license.

## Executive Summary

The maritime industry faces substantive challenges due to increasingly strict air emissions and climate legislation as its practitioners navigate the course towards decarbonisation. Among the broad spectrum of technologies and fuel solutions being considered, wind-assisted propulsion systems (WAPs) are seen as a technology that could reduce the fuel consumption from ships and, consequently, lower their greenhouse gas (GHG) and other emissions.

### Overview of WAPs

There are several types of WAPs that have been developed for the maritime industry; still others remain in development. These systems differ not only in terms of maturity, costs involved and fuel savings potential, but also in terms of their suitability for specific ship types.

While the total number of ships equipped with WAPs is still at a comparatively low level, it is observed that the number of ships that have installed or are planning to install WAPs is increasing.

### Sustainability

Wind energy is a sustainable and renewable source of energy, which is abundant and inexhaustible. Wind propulsion systems allow ships to use this free energy source by converting wind power into thrust, supplementing or even replacing the main engine power of a ship. This leads to less fuel consumption, GHGs and other emissions.

It is difficult to specify an average effectiveness of WAPs, because the reduction of the fuel consumption depends on several factors, ranging from WAP characteristics (e.g., type, number and size of units) and ship characteristics, to operational (WAP and ship related) and environmental factors.

In this study, publicly available results from numerical simulations and measurements, assessing the fuel and emission reduction potential from WAPs, have been gathered. A big variation in the savings has been noticed due to the reasons stated above. Nevertheless, it can be concluded that under favourable environmental conditions the savings can be significant. As an example, rotor sails, which is the technology with the most available data so far, have been found to reveal up to 30% savings.

However, for an investment decision to be made, a ship specific assessment should be opted. Numerical simulations should be carried out, considering the ship and WAP specific characteristics, together with the intended trade ship's routes and expected weather conditions. Crew training is expected to be crucial for the efficient use of WAPs.

### Suitability

In case a WAP is installed on a ship there are several aspects that should be considered. Firstly, deck space is required, the availability of which is often dictated by the ship's type and size. For example, container ships and passenger ships traditionally have less available deck space than bulk carriers or tankers. For ships with space constraints, innovative solutions such as a towing kite or the use of a tug equipped with a towing kite are potentially alternative options. Containerised WAPs have also been developed.

Additionally, a WAP might prevent a ship from passing through bridges or it could hinder loading or unloading by cranes. Potential interference with cargo-handling infrastructure and land-based infrastructure (e.g., bridges) is thus another issue that needs to be addressed. These challenges are often tackled by foldable or tiltable WAP solutions. Such solutions are also used to limit the undesired effects in adverse weather conditions.



Moreover, there are placement criteria which must be fulfilled to guarantee the safe and comfortable use of WAPS (e.g., to avoid obstruction to bridge visibility or locating WAPS next to cabins on passenger ships).

The weight of the units varies significantly among WAPS types, but the subsequent effect on the vessels' cargo capacity is not considered crucial. The ships' structure might require reinforcement for a safe transmittance of the forces generated by a WAPS, but it is not expected to create any technical or financial barriers.

WAPS can be retrofitted on existing vessels or installed on newbuildings and it is worth highlighting that the current share of retrofits is significant.

### **Availability**

In this study, the availability of WAPS is considered along with the availability of wind itself.

The availability of WAPS is only seen as a possible short-term barrier to their potential wider adoption by the maritime shipping sector.

The availability of wind clearly impacts the efficiency of WAPS and this is greatly dependent on the proximity to the coastline, on the specific routes and their direction, as well as seasonal variations. To gain maximum efficiency from WAPSs, voyage optimization will be needed. Trade routes will need to be adjusted to find a balance between wind availability and route length. Also, switching ship deployments to specific trading areas with more favourable wind speeds and directions may be considered. Chartering commitments and clauses would need to be considered.

### **Techno-Economic Aspects**

Due the variations in expecting savings, an analysis is provided to identify the relative fuel savings from the main engine that would be required to recover the annualised costs (over a 15-years period) of the different WAPSs; the analysis has been carried out for different ship types and sizes. Below some highlights are presented:

- The variations in the expected savings together with the uncertainty around the quality of the data sets create a need for assessments to be carried out on a case-by-case basis.
- The results are sensitive on the initial CAPEX assumption.
- The results of the different segments are difficult to compare, since a different number of units of different size have been assumed to be installed, as considered more suitable. This has an impact on the assumed costs and consequently on the required savings but also on the expected savings. Therefore, the calculated required relative savings can only be used as an indication for the assumed number and size of units assumed for each segment. As an example, on a capsized bulk carrier, four large units have been assumed to be installed, resulting in higher required savings. On the other hand, on cruise ships, only one or two units have been assumed, resulting in lower required savings.
- For ships with a relatively high share of auxiliary engine fuel consumption, a WAPS might be a less attractive option compared to ships with a relatively high share of main engine fuel consumption.
- Whether the desired amount of fuel can be saved depends on several factors, including the type of system, the number and size of the WAPS units being installed and the ships' speeds and routing.

- Ships that are engaged in the tramp trades (without fixed schedules), have relatively low route predictability, making system profitability also less predictable.
- It is expected that the return on investment will be shortened over time. This is due to an anticipated drop in system costs and a projected increase in the use of renewable fuels, which are comparatively more expensive than the present fuels. However, the use of such fuels will also imply less carbon cost savings.

## Regulations

The installation and operation of WAPS introduce additional considerations for the safety and performance of the vessels which are not currently addressed in the regulations, standards and guidelines, which in turn may prevent the wider adoption of WAPS on board ships. Flag Administrations and classification societies will need to take a common approach to assessing the specific impacts of WAPS to navigational safety, ship maneuverability and stability, the IMO's Energy Efficiency Design Index (EEDI), helicopter-landing areas, etc.; regulations, standards and guidelines will need to be updated accordingly. At the same time, the International Maritime Organisation (IMO) Revised GHG Strategy, as well as European Union's (EU) 'Fit-for-55' package, setting targets for the reduction of GHG emissions by the use of renewable energy and adoption of zero carbon technologies and fuels, are expected to incentivize the uptake of WAPS.

## Risk and Safety

This study assesses several designs for ships equipped with WAPS from the risk-and-safety perspectives; three specific ship types are analysed:

- A Ro-Pax Ferry using Rotor Sails
- A General Cargo using VentoFoil© (Suction Wings)
- A Wind Propelled H<sub>2</sub> Assisted Container Carrier

The analysis demonstrated that the major concerns related to WAPS for shipping are related to vessel's stability and maneuverability, change in air-draft, operational and navigational obstructions, obstruction in cargo loading/unloading (e.g., for bulk carriers), impact of adverse weather, ice accumulation, fire and lightning protection, noise and vibrations, system and component failures, maintenance.

The issues described above may require further studies for better understanding of the risks as well as for defining the necessary safeguards that will need to be implemented to prevent or mitigate the major hazards. Based on the Hazard Identification (HAZID) studies, preventive and mitigative safeguards as well as recommendations for various ship types are presented, which may help to inform prescriptive requirements and develop inherently safer designs and arrangements. While some safeguards are regulatory requirements, many of these are considered additional safeguards due to the inherent risks of WAPS. Overall, the studies did not identify any major risk that cannot be resolved.

To conclude, for the shipping industry, wind-assisted propulsion is not a new technology. To facilitate its wider uptake on commercial vessels some additional safeguards need to be considered, while WAPS reliability and availability may need to be further improved for the maximum potential benefit to be realised.

# Table of Contents

<b>Executive Summary.....</b>	<b>2</b>
<b>1. Introduction.....</b>	<b>10</b>
1.1 Background .....	10
1.2 Scope and Objectives .....	10
1.3 Acronym List.....	11
<b>2. Use of Wind-Assisted Propulsion in the shipping sector.....</b>	<b>12</b>
2.1 Overview of Wind-Assisted Propulsion Systems .....	12
2.1.1 Wind-Assisted Propulsion Systems .....	12
2.1.2 Current/Planned Applications .....	17
2.1.3 Level of Maturity of Technologies .....	20
2.1.4 Overview of WAPS Conclusions.....	22
2.2 Sustainability .....	22
2.2.1 GHG Reduction Potential.....	23
2.2.2 Air Pollution .....	30
2.2.3 Other Environmental Impacts .....	30
2.2.4 Sustainability Conclusions .....	31
2.3 Suitability .....	31
2.3.1 Weight of Technologies .....	31
2.3.2 Ship's Structure.....	32
2.3.3 Placement Criteria .....	32
2.3.4 Other factors .....	33
2.3.5 Suitability Conclusions .....	35
2.4 Availability .....	36
2.4.1 Availability of Wind.....	36
2.4.2 Availability of WAPS .....	40
2.4.3 Availability Conclusions .....	40
2.5 Techno-Economical Analysis .....	40
2.5.1 Introduction .....	40
2.5.2 Modelling Approach .....	42
2.5.3 Modelling Results.....	48
2.5.4 Financing Options .....	71
2.5.5 Techno-economic conclusions.....	71
<b>3. Safety and environmental regulations, standard and guidelines .....</b>	<b>73</b>
3.1 International Maritime Organization (IMO) Requirements .....	73
3.1.1 Maritime Safety Committee (MSC) .....	73
3.1.2 Marine Environment Protection Committee (MEPC) .....	81
3.1.3 Other Related Regulations.....	88
3.2 International Association of Classification Societies (IACS) .....	89
3.3 International Organization for Standardization (ISO).....	98
3.3.1 CAP 437 Standards for offshore helicopter landing areas .....	101
3.4 Regulations for EU member states .....	102
3.5 Gap Analysis .....	106
3.6 Marine regulation conclusions.....	109
<b>4. Risk assessment using Wind- Assisted Propulsion as Marine Fuel in Merchant ships.....</b>	<b>110</b>
4.1 WAPS Safety.....	110
4.2 HAZID Objectives, Process, Scope and Assumptions.....	110
4.2.1 Objectives .....	111

4.2.2	Common Scope .....	111
4.2.3	HAZID Workshop Methodology .....	111
4.2.4	Limitations .....	112
4.2.5	Risk Ranking .....	113
4.2.5.1	Grouping Systems/Areas for HAZID .....	114
4.2.5.2	Modes of Operation .....	114
4.2.6	Hazards .....	114
4.2.6.1	General WAPS Related Hazards .....	114
4.2.6.2	Common Failure Causes .....	115
4.2.7	General Assumptions – Applicable to all HAZID studies .....	116
4.3	HAZID Results – Findings and Recommendations .....	116
4.3.1	Ro-Pax using Rotor Sail WAPS System .....	117
4.3.1.1	Assumptions – Ro-Pax .....	120
4.3.1.2	Conclusions and Recommendations .....	120
4.3.2	General cargo vessel using VentoFoil© (Suction Wings) .....	122
4.3.2.1	Assumptions – General Cargo ship using VentoFoil© (Suction Wings) .....	124
4.3.2.2	Results and Recommendations .....	124
4.3.3	Wind Propelled H <sub>2</sub> Assisted Container Carrier .....	127
4.3.3.1	Assumptions – Wind Propelled H <sub>2</sub> Assisted Container Carrier .....	129
4.3.3.2	Results and Recommendations .....	129
4.4	Overall conclusion on WAPS HAZIDs .....	130
<b>5.</b>	<b>Overall conclusions of WAPS study .....</b>	<b>133</b>
	<b>References .....</b>	<b>139</b>
	<b>Appendix I – Symbols, Abbreviations and Acronyms .....</b>	<b>143</b>
	<b>Appendix II – Methodology for predicting the propulsion fuel consumption savings from WAPS .....</b>	<b>144</b>
	<b>Appendix III – HAZID Risk Matrix .....</b>	<b>151</b>
	<b>Appendix IV – List of Recommendations – Ro-Pax Ferry vessel using Rotor Sails .....</b>	<b>153</b>
	<b>Appendix V – HAZID Register – Ro-Pax Ferry vessel using Rotor Sails .....</b>	<b>155</b>
	<b>Appendix VI – List of Recommendations General Cargo vessel using VentoFoil© (Suction Wings) ...</b>	<b>196</b>
	<b>Appendix VII – HAZID Register General Cargo vessel using Ventofoil© (Suction Wings) .....</b>	<b>199</b>
	<b>Appendix VIII – List of Recommendations Wind Propelled H<sub>2</sub> Assisted Container Carrier .....</b>	<b>231</b>
	<b>Appendix IX – HAZID Register Wind Propelled H<sub>2</sub> Assisted Container Carrier .....</b>	<b>234</b>
	<b>Appendix X – Detailed Regulatory Gap Analysis .....</b>	<b>266</b>

## List of Tables

Table 1. Overview of wind propulsion systems currently applied.....	16
Table 2. Overview of ships that are (or planned to be) equipped with a WAPS; due to market dynamics, overview might not be exhaustive. ....	17
Table 3. Number of completed or planned wind propulsion systems per technology; companies that have implemented wind propulsion technology; and companies active (but not necessarily having completed installations) per technology*.....	21
Table 4. Typical weights and dimensions for different wind propulsion technologies.....	32
Table 5. Number of ships with installed (and plans to install) WAPS and average number of units, per ship type. ....	34
Table 6. Ship type and size categories and the number and dimension* of WAPS units assumed to be installed.....	43
Table 7. 2021 cost indications for a single unit WAPS, depending on dimension. ....	46
Table 8. Average distribution of fuel consumption over the activities of the different ship types. ....	46
Table 9. Average distribution of the ship's fuel consumption at sea over MEs, AEs and boilers. ....	47
Table 10. Average share of ME fuel consumption in total fuel consumption during cruising & slow cruising...	47
Table 11. Additional assumptions to determine fuel expenditure savings. ....	48
Table 12. Range of required ME fuel saving to cover annual additional costs of WAPS – rotor sail - newbuilding.....	48
Table 13. Range of required ME fuel saving to cover annual additional costs of WAPS – rotor sail - retrofit. .	51
Table 14. Range of required relative ME fuel saving to cover annual additional costs of WAPS – hard sail - newbuilding.....	53
Table 15. Range of required relative ME fuel saving to cover annual additional costs of WAPS – hard sail - retrofit .....	56
Table 16. Range of required relative ME fuel saving to cover annual additional costs of WAPS – suction wing - newbuilding.....	59
Table 17. Range of required relative ME fuel saving to cover annual additional costs of WAPS – suction wing - retrofit.....	61
Table 18. Range of required relative ME fuel saving to cover annual additional costs of WAPS – kite - newbuilding.....	64
Table 19. Range of required relative ME fuel saving to cover annual additional costs of WAPS – kite - retrofit. ....	66
Table 20. Reduction Factors (in %) for the EEDI Relative to the EEDI Reference Line. ....	82



Table 21. Comparison of the Attained EEDI using Different Wind Matrix. ....	85
Table 22. Sea Trials Conditions. ....	99
Table 23. Criteria for Helicopter Landing Areas ....	101
Table 24. Gap Analysis Legend. ....	106
Table 25. Synopsis on Regulatory Gap Analysis for Wind-Assisted Propulsion.....	107
Table 26. Ro-Pax Rotor Sail - HAZID Risk Ranking Summary. ....	121
Table 27. VentoFoils© - HAZID Risk Ranking Summary. ....	125
Table 28. Wind Propelled H <sub>2</sub> Assisted Container Carrier – HAZID Risk Ranking Summary. ....	129
Table 29. Summary of main hazards and causes from HAZID studies. ....	131
Table 30. Summary of the Observations. ....	134

## List of Figures

Figure 1. Rotor sail technology schematic. ....	12
Figure 2. Hard-sail technology schematic. ....	13
Figure 3. Suction-wing technology schematic. ....	14
Figure 4. Kite technology schematic.....	14
Figure 5. Softs-sail technology schematic.....	15
Figure 6. Number of ships (*planned to be) equipped with a wind propulsion system. ....	20
Figure 7. Number of completed and planned installation of systems per technology.....	21
Figure 8. Polar diagram showing the main engine power reduction (%) from two rotor sails in homocentric circles, as a function of relative wind angle for various true wind speeds.....	28
Figure 9. The global trade routes taken into account for wind probabilities in the IMO Global wind-probability matrix as per (MEPC.1-Circ.896) together with qualitative illustration of the trade winds and westerlies (What Are Trade Winds?   NOAA SciJinks – All About Weather).....	37
Figure 10. The average probability distributions of apparent wind angle (left) and speed (right) on the global trade routes based on MEPC.1-Circ.896 data. ....	37
Figure 11. Differences in GHG reduction (averaged per year) for direction of voyage, for different trade routes. Simulation data was obtained for a Capesize bulker (45000 MT DWT) with 4 rotor sails (4m×28m), sailing at 12 knots. Data from Lloyd’s Register (2020). ....	38
Figure 12. Wind power density over global oceans for winter (top panel) and summer (lower panel). Source: (NASA/JPL, 2008). ....	39

Figure 13. Required relative ME fuel saving to cover annual additional costs of WAPS – bulk carrier newbuilding.....	70
Figure 14. Required relative ME fuel saving to cover annual additional costs of WAPS – bulk carrier retrofit.	70
Figure 15. The European Commission ‘Fit-for-55’ package.....	103
Figure 16. EU policies related to maritime transport. ....	103
Figure 17. HAZID Process.....	112
Figure 18. Rotor Sail Ro-Pax General Arrangement.....	119
Figure 19. Rotor Sail General Arrangement. ....	120
Figure 20. General Arrangement General Cargo vessel using VentoFoil© (Suction Wings). ....	123
Figure 21. VentoFoil in resting position. ....	124
Figure 22. Vessel’s profile with sail plan and bridge deck.....	128
Figure 23. Vessel’s route.....	147
Figure 24. Comparison of propulsion fuel oil consumption distributions, before and after installation of WAPS. ....	148
Figure 25. Distribution of encountered weather – pairplots (windand: wind angle, wind: wind speed, wdr: wave direction, hs: significant wave height, tp: wave peak period) .....	149
Figure 26. Main engine power reduction. Homocentric circles correspond to constant values of available power reduction. ....	150

# 1. Introduction

## 1.1 Background

The marine industry is currently facing significant challenges from increasingly stringent environmental regulations. The increase in global temperatures – and the contribution of anthropogenic emissions for which the shipping industry is responsible for about 3% of global carbon-dioxide (CO<sub>2</sub>) output – require prompt action to ensure a more sustainable future.

In April 2018, to the International Maritime Organization (IMO), shipping's governing body, agreed to align itself with goals of the UN's Paris Agreement and reduce the GHG emissions from shipping. The IMO's initial GHG-reduction strategy (Resolution MEPC.304(72)) included an ambition to reduce annual emissions by at least 50% by 2050 (compared to 2008).

This initial strategy was revised in June 2023 (MEPC 80), increasing the levels of ambition to reaching net-zero GHG emissions by or around, i.e., close to 2050, giving impetus for an international shift towards the use of alternative sources of power. The IMO's mid-term measures (technical and economic) have yet to be decided. However, with the typical marine asset having a lifetime of more than 20 years and decisions pending for the new fleet, the transition clearly needs to begin as soon as possible.

At the same time, regulatory developments in the European Union, such as the expansion of the EU Emissions Trading System (EU ETS) to include maritime transport and FuelEU Maritime to incentivise the use of renewable fuels indicate that the regulatory transition is already happening at a regional scale.

In addition to the emerging regulatory framework, the uncertainties of globalisation, geopolitical shifts, digitalisation and cyber risks are all contributing to a complex operating landscape for shipping stakeholders, who depend on the effectiveness of new propulsion technologies and fuel strategies to manage the global fleet.

Wind-Assisted Propulsion Systems (WAPS) are an example of a technology that can help vessels to save fuel and reduce emissions by improving the energy efficiency of the vessel. Depending on environmental and operational conditions, wind can be used to generate forces that could act as an alternative source of power, making it an environmentally friendly source of supplemental energy that is compatible with all fuels and propulsion arrangements.

This study aims to provide an overview of available WAPS technologies, together with suitability and sustainability analyses, offering insights to industry stakeholders and regulators. Additionally, it offers an extensive analysis of the current regulatory framework, techno-economic assessments and a series of detailed risk-based case studies that highlight the commercial and safety implications of using wind-assisted propulsion as alternative sources of power.

## 1.2 Scope and Objectives

The scope and objectives of this study are to consider the technical issues, the regulatory framework and the 'Potential of Wind-Assisted Propulsion in shipping' in response to an EMSA tender (EMSA/OP/43/2020) for 'Studies on Alternative Fuels/Power for shipping'. Some of the analysis was previously detailed in the ABS, CE Delft and Arcsilea proposal of 27 January 2021.

The scope specifically addresses the tasks of the EMSA tender by:

- Providing a state of play on the use of alternative fuel/power in the shipping sector (refer to Section 2 for the related findings).
- Providing a detailed description of the current safety and environmental standards/regulations/guidelines, encompassing goal/functional, technical/design, operational, training,

related certification and approval aspects that could contribute or restrain the uptake of WAPS onboard ships (refer to Section 3 for the related findings).

- Providing a safety assessment of the fuelled/powered cargo and passenger ships engaged in the short-sea (coastal) or deep-sea trades. In total, four safety assessments are offered. If a ship can accommodate cargo and passengers (for example, a Ro-Pax ship), only one safety assessment is needed (for short-sea), without prejudice for conducting the two remaining assessments for a cargo ship (refer to Section 4 for the related findings).

### 1.3 Acronym List

Refer to Appendix I – Symbols, Abbreviations and Acronyms

## 2. Use of Wind-Assisted Propulsion in the shipping sector

This section provides an overview of the state of play for using wind-assisted propulsion in the shipping sector. It is divided into the following sections:

- Overview of the available wind propulsion systems and their suitability, current//planned applications and levels of maturity
- Sustainability aspects, including an overview of their potential to reduce GHG and air pollution
- Availability aspects, including an overview of availability of wind and WAPS units
- Techno-economic analysis

### 2.1 Overview of Wind-Assisted Propulsion Systems

#### 2.1.1 Wind-Assisted Propulsion Systems

Wind propulsion systems are designed to transform wind energy into ship-propulsion power. Depending on the specific type of technology, different physical principles are used in this energy conversion. In addition, the technologies may be distinct in their approach to implementation and installation.

Six categories of wind propulsion technologies are distinguished: rotor sails, hard sails, suction wings, kites, soft sails and hull technology. Aside from these systems/designs, wind turbines for electricity generation on board ships also are being developed. The focus of this study, however, concentrates on the wind propulsion systems that can directly contribute to the propulsion of a ship. It presents an overview of current wind propulsion technologies for maritime shipping, based on literature reviews, internet research, information from the technology providers and input from the International Windship Association (IWSA).

- **Rotor sails** (traditionally also known as Flettner rotors) are spinning rotors, driven by small electric engines that are vertically mounted on the deck of the ship. The active rotation, together with the wind, creates a pressure difference on the cylinder orthogonal to the wind direction – the so-called ‘Magnus effect’ – that in turn provides a propulsive force (ScandiNAOS AB, 2013). Ideally, the rotor should experience a beam wind (90°; 270°) to effectively exploit its high lift (CE Delft, Tyndall Centre, Fraunhofer ISI, Chalmers University, 2016). When sailing straight into a headwind, no savings can be achieved by a rotor, and the savings from a tail wind are comparatively small due to the drag on the rotor (CE Delft, Tyndall Centre, Fraunhofer ISI, Chalmers University, 2016). Also, due to the spinning of rotors, some vibrations and noise should be expected and controlled. The height of present rotor sails ranges from 18-35 m with diameters up to 5m.

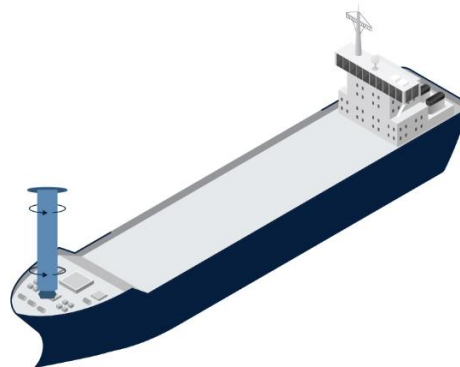

Figure 1. Rotor sail technology schematic.



- **Hard sails** function like traditional soft sails: aerodynamic lift and drag forces are generated by the interaction between the wind and the sails. Hard sails, however, have a rigid geometry and are made of light and strong materials such as carbon fibre. Generally, the sails can be rotated to adjust to wind directions and to maximise propulsion, a function that is often automated. Most hard sails are wing-shaped sails, which is why they are also referred to as wing sails. The geometry of the wing sails resembles that used for airplane wings and the underlying aerodynamics is based on aeroplane physics. The geometry provides more lift and a higher lift-to-drag ratio compared to traditional sails. Current hard sails vary in size, from 12 m in height on small cargo ships up to 50 m on some bulk carriers. As such, the spanning area of the sails varies over two orders of magnitude: from  $\sim 30 \text{ m}^2$  to  $\sim 1,000 \text{ m}^2$ . Some hard sails can be equipped with solar panels to generate extra power.

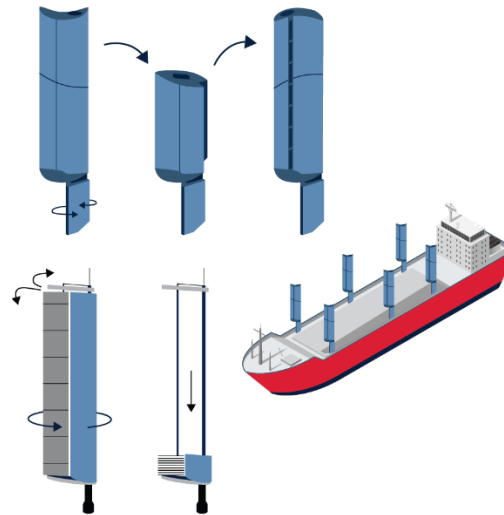

Figure 2. Hard-sail technology schematic.

- **Suction wings** are wing-shaped vertical structures that are mounted onto the deck. In contrast to rotor sails, their outer parts do not rotate to generate thrust, although the wings are orientable, i.e., they can be rotated automatically to adjust to the direction of the wind. The wings have vents and an internal fan and make use of boundary-layer suction to generate thrust, in addition to the thrust that is generated by the wing shape of the sails (as described above for the hard sails). Suction wings deliver optimal thrust at side winds, while their thrust is practically zero at head and tail winds. The height of suction wings ranges from 10-36 m. Two or four wings per ship is common but, in some instances, only one wing is installed. Small suction wings (10 m in height) are also provided as containerised units by one supplier, which makes their location and mode of transportation more flexible.

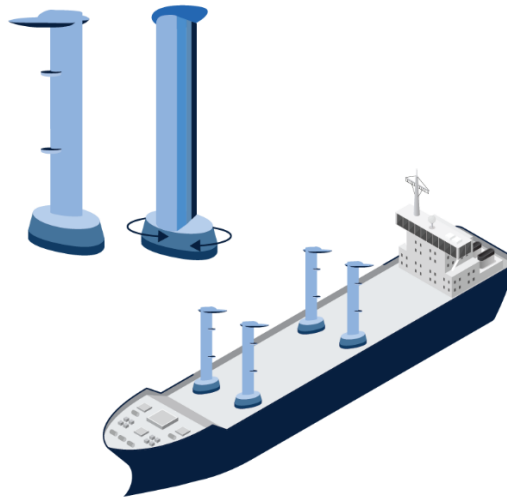

Figure 3. Suction-wing technology schematic.

- **Kites** can be attached to the bow of a ship to generate lift and drag. They need to be launched/retracted, depending on the wind conditions, for which automated systems have been developed. Compared to other technologies, kites can make use of the higher wind speeds found at higher altitudes, although there is a trade-off between altitude and drive-force due to the increase of the elevation angle (Dadd, Hudson, & Sheno, 2010). There are passive and dynamic kites. Passive kites follow the wind direction, while dynamic kites actively move at a high speed to increase the lift (e.g., flying on a figure-eight trajectory). Dynamic kites can generate thrust efficiently downwind, but the thrust they deliver drops quickly as wind angles decrease. Passive kites suffer less from this problem. Small kites for leisure and fishing boats are available in sizes from 10-40 m<sup>2</sup>. For larger ships, the largest kite currently operating is 1,000 m<sup>2</sup>, but kite sizes up to 5,000 m<sup>2</sup> are in development, which potentially could be used in combination, arranged above each other.

To use kites to reduce emissions without having to install and operate them onboard the ship itself, a kite-propelled tug is being developed. This tug would tow ships, making use of the thrust provided by the kite for propulsion. According to the technology provider, this could fully power transoceanic transport.

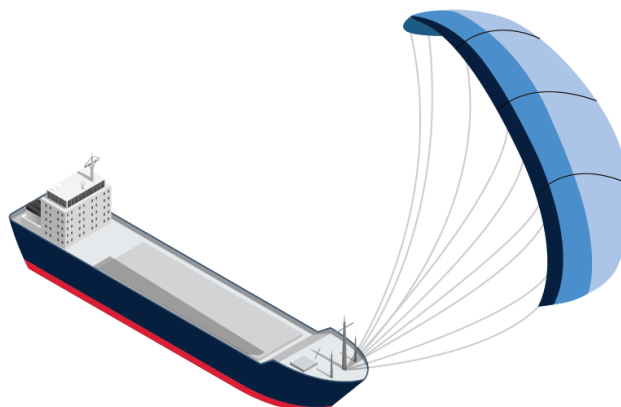

Figure 4. Kite technology schematic.

- **Soft sails** are flexible sails like traditional sails. Just like hard sails, some modern soft sails are wing-shaped to maximise the force of the thrust. In some designs, the masts of the sails serve a double function as cranes, to also be used for loading and unloading. Another approach are inflatable soft sails (Michelin, 2022). These sails are wing-shaped, can be inflated by an air compressor and have a telescopic mast inside. Setting and reefing of these sails is automated, with inflation/deflation of the sail and extension/retraction of the mast synchronised. A prototype of 100 m<sup>2</sup> (scale 1-5) has been tested on a sailing boat and the system is currently being tested on a Ro-Ro cargo carrier. According to the system provider, it is lighter and sails upwind better than a conventional soft sail (DNV, 2023). In some cases, hard sails have proven more efficient than soft sails in reducing fuel consumption. Only three projects for larger commercial vessels currently use soft-sail technology, down from four in 2017 (CE Delft, Tyndall Centre, Fraunhofer ISI, Chalmers University, 2016). Notably, one technology provider switched from designing soft to hard sails after their results found hard sails to be more efficient.

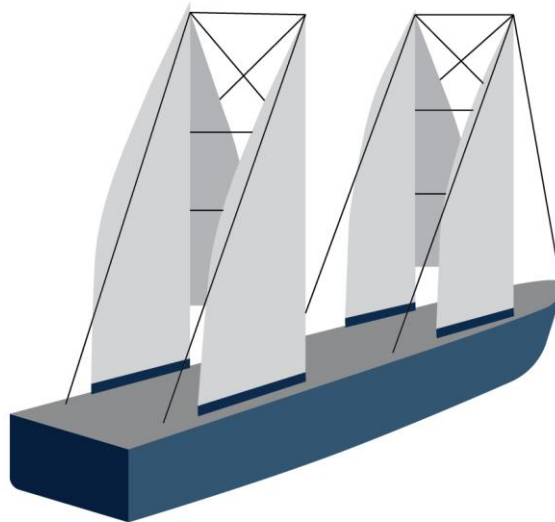

Figure 5. Softs-sail technology schematic.

- The **hull** of a vessel can be shaped like a symmetrical aerofoil, which can generate lift and pull in the ship's direction. This technology can be applied only to newly built ships and is currently limited to a design for a Ro-Ro. A schematic figure can be found in MEPC79-INF.21.
- **Wind turbines**<sup>2</sup> that compare to land-based models also can be installed on ships. The onboard electricity they generate can be used either for propulsion (in the case of electric motors) or to serve part of the demand of other electricity consumers, such as lights or pumps. While wind turbines on ships have been extensively researched, no large-scale prototypes have been developed. Associated start-ups from 2010-2015 do not appear to have remained active. However, there is a recent concept for a wind turbine which includes a large-scale prototype, a horizontal wind turbine placed in the frame of a 40-foot container with open sides to capture wind. The container, which includes the turbine, can be lifted onto a ship, and stapled on top of a traditional cargo container. According to the technology provider (SideWind, 2023), the range of the cut-in and cut-out wind speeds for the turbine is 1.5-40 m per second (m/s); in that range, 20 turbines would be able produce more than 700 kW at a side-wind speed of 20 m/s. Sea trials are pending.

<sup>2</sup> The focus of this study is on the wind propulsion systems that can directly contribute to the propulsion of a ship. Therefore, wind turbines will not be analysed further.

Table 1 provides an overview of companies that are currently providing or developing wind propulsion systems together with the number of ships that have been equipped with such systems so far. Due to the current market dynamics this overview may not be exhaustive.

Table 1. Overview of wind propulsion systems currently applied.

Technology	Company	Project/ company	Name of product	Actual implementations- number of ships	Country
Rotor Sails	Anemoi	Company	Rotor Sails	2	UK
	Dealfeng	Company	Dealfeng Rotor Sail System	0	China
	Enercon	Company	Enercon	1	Germany
	Magnuss	Company	VOSS	0	Sweden
	MariGreen	project	Eco Flettner	2	Germany
	Norsepower	Company	Norsepower Rotor Sail	7	Finland
Suction wings	bound4blue	Company	eSAIL	3	Spain
	Crain Technologies	Company	Suction Wing SW270	0	France
	Econowind	Company	Ventifoil, Ventifoil	5	Netherlands
Hard sails	AYRO	Company	Oceanwings	1	France
	BarTech, Yara Marine	Company	WindWing	2	Norway
	bound4blue	Company	eSAIL	0	Spain
	Chantier de L'Atlantique	Company	SolidSail	0	France
	CWS	Company	Computed Wing Sail	0	France
	DSIC	Company	DSIC	2	China
	Eco marine power	Company	Aquarius MRE	0	Japan
	MOL	Company	Wind Challenger	1	Japan
	NAOS Design	Company	Wind Sail Module	1	Italy
	Nayam	Company	Nayam Wings	0	Israel
	Wallenius	Company	Oceanbird	0	Sweden
	Windship Technology	Company	Windship	0	UK
	Zéphyr & Borée	Company	Windcoop	0	France
Kite	Airseas	Company	Seawing	2	France
	Beyond the Sea	Company	LibertyKite	0	France
	Bluewater Engineering	Company	SKYTUG	0	UK
Soft Sail	Michelin	Company	WISAMO sail	1	France
Hull Sail	Lade AS	Company	Vindskip	0	Norway
Total				30	

Sources: Websites of the different technology providers together with the latest Newsletters as published by IWSA.

## 2.1.2 Current/Planned Applications

By mid-2023, WAPs have been installed on 30 ships and are planned to be or are currently being installed on another 26 ships (refer to Table 2 below for an overview). 16 of these ships are newbuilds, while 38 are being retrofitted; for two ships, it is unclear whether a kite is bound for newbuilds or existing ships.

In more detail:

- Ten ships have been retrofitted with rotor sails (bulk carriers, general cargo ships, Ro-Ro ships, ferries and a tanker). Two newly built ships, a Ro-Ro/Lo-Lo and a VLCC tanker have been equipped with rotor sails. One bulk carrier is 'wind ready', but the rotor sail has yet to be installed. More rotor sail retrofits (3 bulk carriers, 2 tanker, 1 Ro-Ro ship, 1 combination carrier) and newbuilds (3 gas carriers, 1 bulk carrier) are currently on order. One vessel has been retrofitted in 2017 to be 'wind ready'.
- Eight ships have been retrofitted with suction wings (1 fishing vessel, 4 general cargo ships, 1 Ro-Ro vessel, 1 cement carrier), one of which as part of a pilot project on a ship that is used as a theatre. Five other ships are currently undergoing or are going to be retrofitted with suction wings (1 bulk carrier, 1 chemical tanker, 1 container feeder and 2 general cargo ships).
- Hard sails have been installed on seven vessels: one retrofit as part of a pilot (catamaran), two retrofits on bulk carriers, and four newbuilds (2 VLCCs, 1 bulk carrier and a pilot project for a passenger/car ferry). Six other ships are going to be equipped with hard sails: one retrofit as part of a pilot (Ro-ro ship) and five applications on newbuilds (1 bulk carrier), two pilot projects (cargo ships,) and two for which letters of intent have been signed (cruise/large yard).
- So far, one kite has been installed on Ro-Ro ship as part of a pilot and one has been retrofitted on a bulk carrier. Four additional applications on bulk carriers have been announced.

Refer to Table 2 for a detailed overview. The list of systems shown below is intended to include installations on large commercial vessels or installations on smaller vessels of specific systems that have been/are planned to be installed on larger commercial vessels too.

Table 2. Overview of ships that are (or planned to be) equipped with a WAPS; due to market dynamics, overview might not be exhaustive.

Technology	Name company/project	Name of product	Ship name	Ship type	Size (DWT*)	Year of installation	Newbuild / retrofit	Number of units	Status
Rotor sails	Anemoi	Rotor Sail	Axios	Bulk Carrier	81,960	2017	Retrofit	4	'wind ready'; rotor sails not yet installed
			Afros	Bulk Carrier	63,220	2018	Retrofit	4	In operation
			Berge Neblina	Bulk Carrier	388,080	2023	Retrofit	4	Planned
			Berge Mulhacen	Bulk Carrier	211,080	2023	Retrofit	4	Planned
			TR Lady	Bulk Carrier	82,050	2023	Retrofit	3	In operation
			- TBA -	Tanker	400,000	2023	Retrofit	5	Planned
	Enercon	Enercon	E-Ship 1	Ro-Ro/Lo-Lo	10,020	2010	Newbuild	4	In operation



Technology	Name company/project	Name of product	Ship name	Ship type	Size (DWT*)	Year of installation	Newbuild / retrofit	Number of units	Status
	MariGreen	Eco Flettner	Goldy Seven	General cargo	4,200	2018	Retrofit	1	In operation/ performance data collector
			Annika Braren	General cargo	4,750	2021	Retrofit	1	In operation
	Norsepower	Rotor Sail	Estraden	Ro-Ro	9,740	2015	Retrofit	2	In operation
			Epanastasea	Tanker	109,650	2018	Retrofit	2	In operation
			Copenhagen	Ferry	5,000	2020	Retrofit	1	In operation
			SC Connector	Ro-Ro	12,250	2021	Retrofit	2	In operation
			Sea Zhoushan	Bulk Carrier	324,230	2021	Newbuild	5	In operation
			Berlin	Ferry	4,835	2022	Retrofit	1	In operation
			Alcyone	Tanker	50,000	2023	Retrofit	2	Planned
			Delphine	Ro-Ro	27,690	2023	Retrofit	2	In operation
			Koryu	Combination carrier	53,762	2023	Retrofit	1	Planned
			- TBA -	Gas carrier	7,500*	2024	Newbuild	1	Planned
			- TBA -	Gas carrier	7,500*	2024	Newbuild	1	Planned
			Oceanus Aurora	Gas carrier	VLGC	2024	Newbuild	2	Planned
			- TBA -	Bulk Carrier	200,000	2024	Newbuild	2	Planned
Yodohime	Bulk carrier	85,022	2024	Retrofit	1	Planned			
Suction wings	bound4blue	eSAIL	La Naumon	Theatre ship	1,006	2021	Retrofit	1	In operation (pilot)
			Balueiro Segundo	Fishing vessel	n/a	2021	Retrofit	1	In operation
			Eems Traveller	General cargo	2,850	2023	Retrofit	2	In operation
			Crimson Kingdom	Bulk Carrier	84,860	2023	Retrofit	4	Planned
	Econowind	Flatrack Ventifoil	Frisian Sea	General cargo	6,480	2021	Retrofit	2	In operation
				General cargo	3,600	2020	Retrofit	2	In operation
		Ventifoil	Annie	General cargo	5,100	2021	Retrofit	2	In operation
				General cargo	5,100	2021	Retrofit	2	In operation
		Containerised Econowind unit	Marfret Niolon	Ro-Ro	5,300	2022	Retrofit	4	In operation
				Container feeder	1,036	2023	Retrofit	2	Planned

Technology	Name company/project	Name of product	Ship name	Ship type	Size (DWT*)	Year of installation	Newbuild / retrofit	Number of units	Status
		Ventofoil	Proud	General cargo	6,500	2023	Retrofit	2	Planned
			Perfect	General cargo	6,500	2024	Retrofit	2	Planned
			Sunnanvik	Cement carrier	9,060	2023	Retrofit	4	In operation
			Chemical Challenger	Chemical tanker	16,111	2023	Retrofit	4	Planned
Hard sails	AYRO	Ocean-wings	Energy Observer	Catamaran	-NK-	2019	Retrofit	2	In operation (pilot)
			Canopée	Cargo ship	4,700	2023	Newbuild	4	In operation (prototype)
	BarTech, Yara Marine	WindWing	Berge Olympus	Bulk Carrier	211,150	2023	Retrofit	4	In operation
			Pyxis Ocean	Bulk Carrier	80,962	2023	Retrofit	2	In operation
	DSIC	DSIC AeroFoil	New Vitality	Tanker	306,750	2018	Newbuild	2	In operation
			New Aden	Tanker	306,470	2022	Newbuild	4	In operation
	MOL	Wind Challenger	Shofu Maru	Bulk Carrier	100,420	2022	Newbuild	1	In operation
			- TBA -	Bulk Carrier	- TBA -	2024	Newbuild	1	Planned
	NAOS	Wing Sail Module	GNV Bridge	Passenger/car ferry	8,600	2021	Newbuild	1	In operation (pilot)
	Wallenius	Oceanbird	Tiranna	Ro-Ro	30,090	2024	Retrofit	2	Planned (pilot)
	Chantier de L'Atlantique	SolidSail	Orient Express Silenseas	Cruise/yard	- TBA -	2026	Newbuild	3	Letter of intent signed
			- TBA -	Cruise/yard	- TBA -	2026	Newbuild	3	Letter of intent signed
			Neoliner	Cargo ship	5,000	2023	Newbuild	2	Planned (pilot)
Kite	Airseas	Seawing	Ville de Bordeaux	Ro-Ro	5,290	2021	Retrofit	1	In operation (pilot)
			Cape Brolga	Bulk Carrier	Capesize	2022	Retrofit	1	Installed
			Corona Citrus	Bulk Carrier	88,700	- TBA -	Retrofit	1	Planned
			- TBA -	Bulk Carrier	210,000	2024	Newbuild	1	Planned
			- TBA -	Bulk Carrier	- TBA -	- TBA -	- TBA -	1	Planned
			- TBA -	Bulk Carrier	- TBA -	- TBA -	- TBA -	1	Planned

Technology	Name company/project	Name of product	Ship name	Ship type	Size (DWT*)	Year of installation	Newbuild / retrofit	Number of units	Status
Soft sail	Michelin	WISAMO sail	MN Pelican	Ro-Ro	8,600	2023	Retrofit	1	In operation (prototype)

\* m<sup>3</sup> for gas carriers; TEU for container

Based on the information above, Figure 6 provides the number of ships that are/will be equipped with WAPs; it differentiates retrofits from newbuilds, and clearly illustrates that adoption of the technologies is increasing.

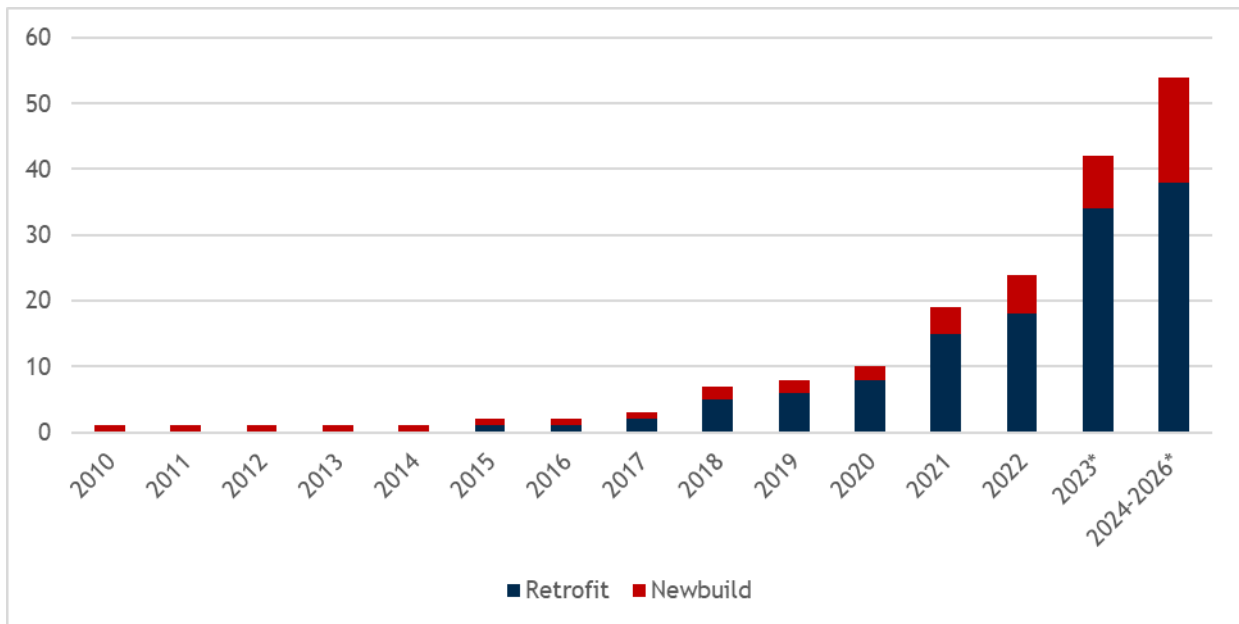

Figure 6. Number of ships (\*planned to be) equipped with a wind propulsion system.

### 2.1.3 Level of Maturity of Technologies

In this paragraph, the technological readiness of the wind propulsion technologies is assessed and placed in three categories: ‘mature’, ‘near-mature’ and ‘non-mature’. In terms of technological readiness levels (TRL), mature technologies have the highest TRL of 9: the system is seen as complete and fully proven in an operational environment. Mature wind propulsion technologies have been installed on ships (either newbuilds or retrofitted on existing ships, depending on the technology) to be used on a permanent basis. Near-mature technologies are defined as technologies that have been in operational use, in demonstration, or for test projects, but (still) have specific limiting factors that prevent them from entering the market. This corresponds to TRLs of 7 or 8. Technologies are considered non-mature if they have not been implemented or demonstrated (during test projects) in an operational environment. This would generally correspond to a TLR of less than or equal to 6. There is a large range in the readiness of the technologies.

Table 3. Number of completed or planned wind propulsion systems per technology; companies that have implemented wind propulsion technology; and companies active (but not necessarily having completed installations) per technology\*.

Technology	Completed/planned implementations	Companies that have completed implementations	Total companies active in technology
Rotor Sail	23	4	6
Suction wing	13	2	3
Hard sail	13	5	13
Kite	6	1	2
Soft sail	1	1	3
Hull design	0	0	1
<b>Total</b>	<b>56</b>	<b>13</b>	<b>28</b>

\*Scope is consistent with Table 2: Installations on large commercial vessels or installations on smaller vessels of specific systems that have been/are planned to be installed on larger commercial vessels too are considered.

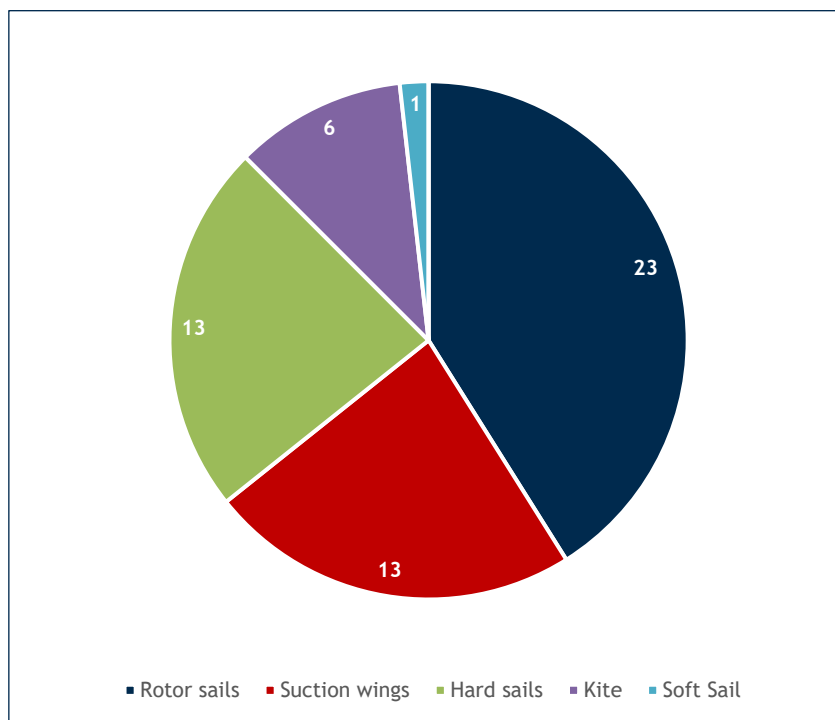

Figure 7. Number of completed and planned installation of systems per technology.

### 1. Mature technologies

Hard sails, suction wings and rotor sails have been proven to be technologically ready. A variety of ships have been equipped with these types of wind-assisted propulsions systems. Having proven their technological readiness, the number of installations has been increased, although the number of applications is still relatively small. These types of wind propulsion feature multiple companies developing this technology up to a mature level. Despite technological maturity, many of these technology providers are still dependent on loans for their production and/or to increase capacity. (Chambers, 2023), (bound4blue, 2023))

- As can be seen in Figure 7, more than one third of wind-assisted ships are equipped with rotor sails, currently the most popular form of wind-assisted propulsion. Installations from two companies in 2015 and 2017 have shown the technology to be fully mature and have led to an increase in supply. With the exception of one newly built ship with rotor sails since 2010, all other rotor sails have been retrofitted.
- Thirteen of the installed wind propulsion technologies are suction-wing models. The technology of suction wings is characterised by fast development; all installations have taken place since 2020. All suction wings have been retrofitted. To date, this technology has been mainly implemented on cargo ships.
- Thirteen wind-assisted ships are currently equipped with hard sails, of which most are wing sails. Suppliers differ in their techniques to make sails foldable or collapsible, while non-collapsible sails are also installed. Whereas rotor sails and suction wings are mostly supplied by a small number of companies, hard sails are provided by a greater variety of companies. Each company has installed their technology on either one or two ships to date, indicating the slightly lower stage of development, compared to suction wings and rotor sails.

## 2. Near-mature technologies

To date, modern soft-sail systems and kites have both been tested in sea trials, which means that their technological readiness is relatively high. However, full-scale applications are limited, which indicates a comparatively lower stage of development compared to hard sails, suction wings and rotor sails:

- Modern soft-sail systems have been installed on two superyachts as a wind-assisted propulsion technology (DynaRig), but there have been no pilots on large maritime transport vessels yet. It is observed that a research company decided to switch to hard-sail technology at the expense of soft-sail technology, expecting hard sails to offer equivalent or better performance and maintenance costs to be less (Neoline, 2022). Nevertheless, a prototype of a new soft-sail technology (WISAMO) has recently (September 2023) been announced to be tested on a Ro-Ro vessel (Ferry Shipping News, 2023) .
- The first full-scale application of a kite has been installed at the end of 2022 and several more are planned. It is noted that these applications are still supported by government funding.

## 3. Non-mature technologies

Of the wind propulsion categories, the hull design shaped like a symmetrical aerofoil is the only non-realised technology. There are two reasons for this: firstly, hull sails require a specially designed vessel therefore, only newly built ships can apply this technology. Secondly, to date, only one company is active in this research area. This technology will not be considered in this study.

### 2.1.4 Overview of WAPS Conclusions

There are several different wind propulsion systems that have been and are being developed for the shipping industry. WAPSs have been installed to different ship types and sizes as retrofits, but also on new building vessels. Although the total number of ships equipped or planned to be equipped with WAPS is still not significant, in the last decade there is a clear indication of an increased uptake of this technology.

## 2.2 Sustainability

Wind energy is a sustainable, renewable source of energy which is abundant and inexhaustible. Wind propulsion systems allow ships to use this free energy source by converting wind power into thrust. The wind power can



be used to supplement or even replace the main engine power of a ship, leading to lower fuel consumption, GHG emissions, air pollution and underwater radiated noise.

Naturally, WAPS are also expected to have a positive impact on the IMO and EU energy efficiency indices and carbon intensity metrics and emission trading schemes. More details and considerations can be found in subsection 3.1.2 and 3.4.

### 2.2.1 GHG Reduction Potential

The performance, fuel and emission reduction potential of WAPS depend on several internal and external factors. These factors include:

- WAPS-related factors:
  - Type of WAPS
  - Number and dimensions of WAPS units
  - Position of WAPS units on the ship
  - Type of installation (retrofit or newbuilding)
  - Operation/automation
- Environmental factors:
  - Weather conditions
- Ship-related factors:
  - Technical characteristics
  - Operation of the ship
  - Crew training

These factors, which are interrelated, will be analysed in the following paragraphs. Subsequently, the methods for determining the savings potential will be discussed. Finally, an overview of the range of savings reported for the various types WAPSS will be presented, together with some technology-specific findings.

#### WAPS-related factors

Different fuel savings can be expected from the different types of WAPS. It is also noted that all WAPS are expected to consume at least a small amount of energy, e.g., for the automated use of the systems (e.g., for a change of the orientation, for tilting etc.), whereas dynamic systems, like rotor sails, suction wings and dynamic kites, require more energy to produce thrust.

By increasing the number and the size of WAPS-units, more thrust is expected to be produced and therefore more savings. However, the interaction between multiple installed units can reduce the overall expected savings, so the arrangement should be selected carefully. When a system is fitted on a new building, there is more room for optimisation on the design and consequently on WAPS performance.

The longitudinal position of the system on the ship has also been found to play an important role on the efficiency, affecting the yaw moment. Simulations on a ferry found that a position of the installation more towards the aft can increase its lift-to-drag ratio (Thies & Ringsberg, 2021). This means that the rudder can generate more turning force with less drag. However, this should be further investigated as it might have a negative impact on course keeping ability of the vessel, resulting in energy losses. Despite these considerations, in practice the location of the system is mainly selected in a way that the interference with sight, loading structures and other equipment is avoided.

For all technologies, the orientation of the system with respect to the wind conditions is a crucial factor affecting the thrust force delivered. Therefore, the degree of automation and software dependency may determine to some extent the effectiveness of the system. Fully automated systems require limited crew experience and at the same time, the software can be updated continuously to further optimise performance. On the other hand, fully automated systems are dependent on the limitations of the software, where in some cases the human interpretation of available and additional data (such as weather) may have a positive impact on the reduction in fuel consumption or even on safety. In automated systems, though, crew training would be less crucial for WAPS's effective use.

### Environmental factors

The amount of thrust that can be produced by WAPS depends on the wind speed and angle. All technologies will deliver increased thrust force under favourable weather conditions and sailing routes. However, what is considered as a favourable condition may differ among the various systems and depends on the physical characteristics of the individual installation, such as the number and sizes of the units.

It is observed that when the wind angle is favourable, a higher wind speed will allow the WAPS to produce more thrust, assuming a constant ship's speed. These effects are typically captured in 'polar diagrams' (Figure 8 is given as an example).

Nevertheless, it should be highlighted that higher wind speeds also create larger waves. This naturally results in a deterioration of ship's performance due to increased wave resistance (Chou, Kosmas, Acciaro, & Renken, 2021), which should be also captured in the polar diagram. In harsh weather conditions, safety considerations may prompt decisions to switch off or tilt the WAPS. Stability and manoeuvrability should be considered (see subsection 3.1.1), while the technology provider will need to specify the maximum operational and survival wind speed limits of the WAPS.

Considering the importance of the environmental factors, the selection of the route is critical to maximise the potential of the WAPS, so that the most favourable conditions can be met during the voyage. Voyage optimisation services and software are available for this purpose, some of those are provided by WAPS manufacturers.

Crew experience and training is considered of paramount importance, especially in case where the system is not fully automated.

For more details on the environmental factors, see subsection 2.4.1.

### Ship-related factors

The size of the ship determines the maximum number of units that can be installed, as well as their dimensions. As mentioned earlier, these aspects have a great influence on the WAPS performance. It should be noted that for a WAPS to be effective, minimum dimensions may be required.

At the same time, the ship's size and hydrodynamic performance determine the propulsion power needed. The bigger and the heavier<sup>3</sup> a ship is, the more power would need for propulsion. This propulsion power is translated to fuel consumption by multiplying the power with the Specific Fuel Oil Consumption (SFOC; [measured in g-fuel/kWh]) of the ship's main engine. The SFOC depends on the engine load and is typically optimised so that this is lowest at the load that corresponds to the design speed.

---

<sup>3</sup> The total weight of the ship is the sum of the deadweight and lightweight. This is called the displacement, since it can be calculated from the volume of water displaced by the ship. The deadweight is defined as the carrying capacity of the ship, excluding its own weight (lightweight). The lightweight is the mass of the ship including machinery, but excluding additives such as cargo, fuel, crew, water, etc.

With WAPS in operation, a ship is expected to sail at lower engine loads (assuming that the speed is kept constant) leading to an overall lower main engine fuel consumption. This means that the engine may operate at a sub-optimal load with a higher SFOC, affecting the total expected savings. As an example, an engine may have a SFOC of 175 g-fuel/kWh when sailing without the WAPS (e.g., with an engine running at 14,000 kW). Assuming a 1,000 kW power savings from the WAPS and an increase of 1 g-fuel/kWh in SFOC, the actual savings would be around 0.3 tonnes less due to the increase in SFOC (i.e., 3.9 instead of 4.2 tonnes of fuel per day which, in relative terms, leads to a saving of 6.6% instead of 7.1%). However, it is noted that for several vessel segments it is not uncommon to operate for significant period of time at off-design conditions. This loss of efficiency can be compensated by adjusting the tuning of the engine.

Also, in case a ship is operated at higher speed, the baseline fuel consumption (i.e., the fuel consumption without the use of the WAPS) is higher, which means that the relative reduction potential of the WAPS is lower (assuming that the performance of the WAPS is not affected). Taking into account the example above, increasing ship's speed by 0.5 knots would result in about a fuel consumption of 7.6 tonnes/day (without the use of WAPS). Assuming again 1000 kW power savings from the use of WAPS and the same increase in SFOC, the approximate fuels savings would be around 3.8 tonnes per day. This constitutes fuel savings of about 5.8% (less than what calculated earlier, due to the higher baseline fuel consumption).

It is, however, noted that the speed of the ship may, under the same environmental conditions, also have an impact on the thrust that the WAPS produces. For rotor sails, for example, the thrust can, up to a certain point, be expected to increase with the speed of the ship (see for example Lele Akshay, 2017). Taking into account the same example as above, by increasing vessel's speed: In case the thrust increases, the absolute power savings will increase (i.e., more than 1000 kW in this case). However, the relative savings may still be reduced due to the increased baseline fuel consumption (corresponding to higher vessel's speed). If the thrust declines, the absolute power savings will decrease, and the relative savings would be reduced even further.

Similar variations in daily fuel consumption of a vessel (baseline consumption) and therefore in relative savings from WAPS may also be expected due to variations in environmental conditions but also due to hull fouling. An example of the daily variation in fuel consumption can be seen in Figure 24.

For the reasons above, WAPS performance may be better communicated in terms of absolute propulsion thrust force produced (in kiloNewtons) [kN] and/or power saving performance (in kW), rather than the percentage of the fuel or power saved.

Due to the overall complexity and the multiple factors that determine WAPS performance, an annual average percentage reduction of the different WAPS is better determined on a case-by-case basis rather than for fleet segments. This is to be based on intended vessel's operational profile and intended routes, as well as the distribution of the weather data in each route (see Appendix II – Methodology for predicting the propulsion fuel consumption savings from WAPS).

Also, there are several online tools developed to allow ship operators to gain a better understanding of the reduction potential for specific ship types and routes.

- the Flettner Rotor Savings Estimator (Lloyd's Register, 2020) allows the operator to assess the fuel-reduction potential that can be achieved by rotor sails on six alternative routes, depending on the season, ship type specifics, ship speed, loading conditions and the different dimensions and configurations of the rotor(s);
- the BlueRoute tool (Marin, n.d.) gives the relative and absolute fuel consumption savings (in terms of gCO<sub>2</sub> per tonne nautical mile) for laden and ballast voyages and for a NewcastleMax bulk carrier if equipped with 4 rotor sails on routes specified by the user. The tool is considered a prototype and is further expanded as part of the WiSP2 project (Marin, 2022);
- the Norsepower Performance Simulator, provided by a rotor sails supplier (Norsepower, n.d.), gives the average annual fuel and CO<sub>2</sub> savings (in tonnes) that can be achieved by one rotor for six different routes and five alternative dimensions of the rotor.

These may give an indication of the expected savings; however, they do not take into account the vessel's and WAPS's specific hydrodynamic and aerodynamic characteristics.

## Methods to determine savings potential

The reduction potential of WAPSs can be determined/estimated in different ways. The methods can be divided into two categories: numerical simulation and measurements.

### *Numerical simulations*

Numerical simulations calculate the reduction in propulsion power based on several input variables, such as the thrust generation from WAPS, wind velocities, ship route, etc.

A methodology is provided (Appendix II – Methodology for predicting the propulsion fuel consumption savings from WAPS) for a defined route (departure and arrival port), a given time-period, vessel draft and service speed. The model is based on ship propulsion principles and uses as input vessel's and WAPS's hydrodynamic and aerodynamic characteristics, simulating (Monte Carlo) vessel's fuel consumption with and without the use of WAPS.

Another savings-prediction model for rotor, rigid wing sails and DynaRigs uses the main particulars of the vessel and generic configuration of the WAPS as input. Subsequently, the results are compared to measurements on the *M/V Maersk Pelican* (vessel has been renamed to *Epanastasea*) (Reche-Vilanova, Hansen, & Bingham, 2021). For numerical simulation purposes, the drag and lift characteristics of a WAPS can be derived via laboratory tests or computational fluid dynamics (CFD). Some vendors (e.g., in the U.K. and Singapore) perform full-scale laboratory tests, having rotors of real size exposed at real wind conditions to validate the savings. The validity of these results depends on the wind conditions, e.g., the uniformity of the wind speed and direction over time that would mimic the anticipated conditions in the open seas.

### *Measurements*

During measurements, fuel and/or emission reduction is determined by monitoring the performance data of the WAPSs. Full-scale operational tests can be further divided into long-term monitoring and short trials.

An example of the latter is an analysis (SSPA, 2023) based on data from long- or short-term measurements. The results of a speed trial on the *M/V Copenhagen*, equipped with one rotor sail, are extrapolated with a ship simulation programme to calculate the annual fuel savings. The trial provides measurements for the differences in speed and power for runs with and without the rotor. Subsequently, a statistical route analysis is used to extrapolate the trial results. This specific model uses a Monte Carlo simulation over different combinations of environmental conditions along the route considered. Although these calculations are based on generic assumptions on weather conditions, numbers for annual savings can be derived from relatively short and cheap trial runs. This and other similar methods also can be used for other WAPS technologies.

## Overview of the savings reported for the various types WAPSs

### *Rotor Sails*

According to rotor sail providers, the maximum thrust that one rotor sail can produce ranges from 175 to 385 kN, depending on the dimension of the rotor sail.

Multiple measurements and simulations have been undertaken to determine the potential for rotor sails to reduce the fuel consumption and related emissions. The potential of rotor sails seems to have been investigated the most among the different WAPS technologies so far.

Measurements revealed the following fuel savings/power consumption reductions<sup>4</sup>:

- A trial on the general cargo ships *M/V Annika Braren*, equipped with one 18x3 m rotor sail, reported 15% savings on favourable wind angles. A typical reduction was estimated to be in the range of 2-4.5% (SSPA, 2022).
- On the Ro-Ro vessel *M/V Estraden*, equipped with two 18x3 m rotor sails, an average fuel saving of 6.1% was measured on the route between Rotterdam and Teesport (UK).
- On the hybrid ferry *M/V Copenhagen*, equipped with one 30x5m rotor sail and sailing between Rostock (DE) and Gedser (DK) an average fuel saving of 4% has been determined.
- For the Ro-Pax vessel *M/V Viking Grace*, equipped with one 24x4 m rotor sail and sailing on the route Turku (FI) to Stockholm (SE) a reduced power consumption of 207 to 282 kW was established<sup>5</sup>. This equals to be 231 to 315 tonnes of fuel per year.
- On the tanker *M/T Maersk Pelican* (vessel has been renamed to *Epanastasea*), equipped with two 30x5m rotor sails, mainly trading between Middle and Far East, an average fuel saving of 8.2% was measured.
- For the Ro-Ro ship *M/V SC Connector*, equipped with two 35x5 m rotor sails, an average fuel saving of 20-25% has been reported.
- For the bulk carrier *M/V Afros*, equipped with four 16x2 m rotor sails, a fuel saving of 12.5% was estimated for the route between Nantong (CN) to Vancouver (CA).
- For the VLOC *M/T Sea Zhoushan*, equipped with five 24x4 m rotor sails, an average fuel saving of 8% has been reported.

One publication (Chou, Kosmas, Acciaro, & Renken, 2021) summarised the reduction potential of rotor sails based on information available up to 2019. The measured and calculated fuel savings vary significantly from 1% to 30% and were largely dependent on the type of ship, her weight and the number of rotor sails installed. Moreover, the route and wind conditions were found to play major roles in the fuel savings on specific routes.

Another study (CE Delft, Tyndall Centre, Fraunhofer ISI, Chalmers University, 2016) considered different sample ships and typical worldwide trades of these ship types/sizes, and estimated 5-17% power savings range for higher vessel speeds and a 7-23% power savings range for lower vessel speeds, again depending on ship type, the number of rotor sails and their dimensions.

It has been found that the power savings from rotor sails do not necessarily increase proportionally with the number of units installed, as the aerodynamic interaction among them can worsen their performance (Bordogna, et al., 2020). Such potential loss in performance is determined by the specific technical details of the installation (spacing of the rotors), situational positioning of the ship relative to the wind and the automation of the rotor sails (rotor-velocity settings). The performance is markedly worsened when they are set closer to each other and this is even more obvious when the rotor sails are aligned in the apparent wind direction.

Based on numerical calculations (Traut, et al., 2014) estimated a range of fuel savings of 2-21% from one rotor sail of 35x5 m<sup>2</sup>, depending on the ship type, size and route.

One study (Lu & Ringsberg, 2020) concluded on a fuel reduction 8.9% with one rotor sail of 18x3 m<sup>2</sup> installed on an Aframax Oil Tanker. The reduction was slightly higher than the reductions found for wing sails and soft sails.

---

<sup>4</sup> As found in publicly available sources.

<sup>5</sup> Rotor sail has been removed from this vessel.

Simulation data (SSPA, 2023) has shown the relation between power savings (including the power consumption of the rotor) and the wind speed and relative wind angle. The extrapolation of measurement data was calculated for the *M/V Copenhagen*, which was equipped with one rotor of 30 m in height with a diameter of 5 m. At low wind speeds (4 m/s), the power savings are about 0-4%; for higher winds speeds (12 m/s), power savings over 25% were reached at optimal angles. For these data sets, the ship speed and air density were assumed to be constant.

As explained earlier, wind propulsion technologies generate thrust from wind energy, more fuel can be saved when the route is optimised to the weather conditions. Therefore, higher savings can be expected when voyage (route) optimisation is in place. One publication (Norsepower, Napa, 2022) concluded that the average fuel reduction of rotor sails can be increased from 9% to 25% (in tonnes of fuel per day) if voyage optimisation is considered. These calculations were carried out for a ship with three rotor sails of 35 m in height and 5 m in diameter and an increase of the total distance travelled due to voyage optimisation was considered under the assumption that the total travel time is kept constant.

Figure 8 provides an indication of the main engine power savings (%) of two rotor sails as a function of relative wind angle and true wind speeds for a sample vessel (100,000 DWT tanker) sailing at 12 knots. Since the lift force generated by the rotors is always perpendicular to the apparent wind speed, the power savings are maximised for relative wind angles close to  $\pm 90$  degrees.

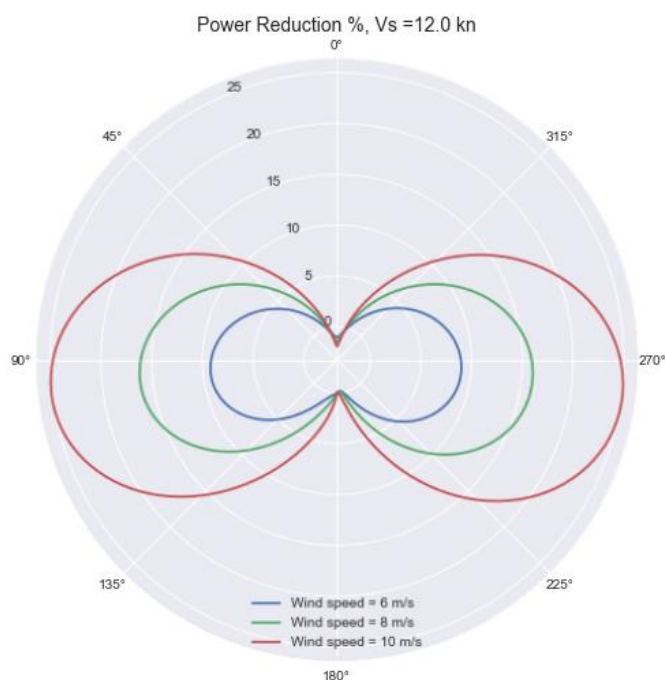

Figure 8. Polar diagram showing the main engine power reduction (%) from two rotor sails in homocentric circles, as a function of relative wind angle for various true wind speeds.

### Hard sails

Although the installation of hard sails -- wing sails, in particular -- has been increasing during the last years, data remains limited on this technology's potential to reduce fuel consumption. The data publicly available are mainly from simulations. Moreover, there is a rather disparate range of findings on potential fuel savings, ranging from ~2% to ~50%.



The Wind Challenger project is developing telescopically reefable hard sails that promise to reduce fuel consumption by 50% when nine sails are installed on a capesize bulk carrier. Simulation considering a specific route (Yokohama/Seattle) found potential fuel savings could be in the range of 20-30% (Ouchi, Uzawa, Kanai, & Katori, 2013). When a single hard sail was installed on the *Shofu Maru*, simulations indicated a 5% fuel reduction on a Japan-Australia voyage and 8% from Japan to North America (MarineLink, 2022).

Based on a high-level calculation for a particular popular route for oil tankers, a 2.6% reduction in fuel consumption per voyage was estimated for a tanker equipped with five wing sails, conservatively assuming an average wind speed of 7m/s (Ariffin & Hannan, 2020). Another study (Lu & Ringsberg, 2020) indicated that wing sails performed slightly worse than rotor sails (6.1% vs. 6.5%; and 8.8% vs. 8.9% on two separate routes). These results were calculated by modelling one 1,000 m<sup>2</sup> wing sail on an aframax oil tanker.

Simulations of two 35×12 m<sup>2</sup> wing sails on the Ro-Pax *Ciudad de Mahón* (design speed 21 knots) were found to reduce fuel consumption by 7 to 22% with 15% savings in a 'realistic scenario' (Díaz, 2020). One study (CE Delft et al., 2016) considered different sample ships and typical worldwide trades of these ship types/sizes and calculated a 5-18% power saving range for higher vessel speeds and an 8-24% power saving range for lower vessel speeds, depending on ship type, the number of wing sails and their dimensions.

The latest wing sails have flaps to enhance performance. An aerodynamic analysis suggests wing sails have 20-50% more lift and drag coefficients when they have flaps (Lee, Jo, Lee, & Choi, 2016). The analysis also indicates that, similar to rotor sails, interaction between multiple wing sails can reduce their thrust performance.

Based on a numerical model, a potential to reduce fuel consumption by 10% for a ship with eight wings was estimated (Viola, Sacher, Xu, & Wang, 2015). Further, the results suggest that it may be more efficient to employ several tall wing sails rather than fewer shorter but larger wing sails. Also, based on this model, lower vessel speeds were found to be beneficial for the relative fuel reduction, because the ship's resistance decreases.

Three-dimensional computational models also found wing sails to be most efficient when the vessel speed is low. In this model, the thrust of three sails was equal to three times the thrust of one sail. However, for five sails, the total thrust was only 3.83 times the thrust of one sail. In other words, the interaction between the wind and multiple sails has a negative effect on the average reduction per sail. The exact effect depends on the spacing and height of the sails; wind conditions also play a role (Mboumba Mboumba, 2022).

### *Suction wings*

According to a suction wing producer, one suction wing with a height of 10-16 m can reduce the engine power by over 200 kW. Two suppliers of suction wings expect their products to lower fuel consumption by up to 20% or 40% respectively. These percentages depend on number of wings, their dimensions and vessel types.

A limited amount of measurement data is available on the performance of suction wings. Speed trials were performed on the multi-purpose, dry cargo vessel *M/V Frisian Sea* (SSPA, 2022a), which was equipped with two 10×3 m suction wings. These measurements were used to extrapolate the power savings for all wind conditions. The estimated power savings, on specific routes, were calculated between 2% and 4%. The ship sailed at a constant speed of 10 knots with the wind power replacing part of the engine load.

It has been found that the lift-to-drag ratio increases with sail area, but the increase is not always linear. Increasing the sail area was found to be more beneficial for suction wings compared to rotor sails (Thies & Ringsberg, 2021). However, when two suction wings interact, depending on their relative position the thrust force coefficient may be reduced by up to 16% (Borren, 2022). For rotor sails, this effect may be smaller due to the relatively small size of their span, while for hard wings and suction wings this effect is more significant. (Thies & Ringsberg, 2021). Interestingly, the thrust can be increased when the angle of attack of each suction wing is optimised independently, increasing the thrust force coefficient by about 5-11%, compared to a case with no independent optimisation (Borren, 2022).

### *Kites*



Compared to rotor and sail technologies, less research and modelling has been done on the performance of kites as a wind propulsion technology. This also reflects the fact that the technology is less mature compared to the other technologies. The lack of data makes it particularly difficult to estimate the savings potential of kites.

While hard sails and suction wings are relatively more efficient at lower ship speeds, kites support a greater reduction of fuel consumption at higher ship speeds. According to a former technology provider, trials on the general cargo vessel, *M/V Theseus*<sup>6</sup>, resulted in a 40% reduction in fuel consumption at 10 knots; while at 4 knots the reduction was 17%. Trials on the *MS Beluga Skysails*<sup>7</sup> (vessel has been renamed to MS Onego Deusto) resulted in 10 to 35% savings (Díaz, 2020). The manufacturer estimated that an average fuel reduction of 10-15% was possible with their technology (Misra-Godwin, 2016); however, production of this technology has been discontinued. Meanwhile, another company is developing kite systems, which they believe will help to reduce fuel consumption by 20-40%.

A numerical model calculated the fuel savings for a 500 m<sup>2</sup> kite (Traut, et al., 2014). The amount of savings is ranging from 1% to 32%, depending on the ship type and route. Considering a kite of 400 m<sup>2</sup>, (CE Delft et al., 2016) calculated a 1-9% power savings range for higher vessel speeds and a 2-15% power savings range for lower vessel speeds, considering different sample ships and typical worldwide trades of these ship types. Numerical simulations of a 375 m<sup>2</sup> kite installed on the passenger/Ro-Ro Ciudad de Mahón (design speed 21 knots) were found to reduce fuel consumption by 4 to 13% with 9% savings in a 'realistic scenario'. (Díaz, 2020).

To conclude, it is observed that there is a large variation on the savings estimated by the various technology providers and researchers for the different WAPS. Apart from the numerous factors that determine the actual WAPS performance, the method for estimation and the way the results are presented play an important role. The savings could be estimated at a single speed, vessel's draft and weather condition or at a distribution of those. They could be predicted with or without optimisation. Also, in some instances the thrust savings are presented, while in other cases the propulsion power or fuel savings are given. Sometimes it may not be clear if the consumption of the WAPS, if any, is included. Therefore, the estimated savings are not always comparable.

### 2.2.2 Air Pollution

As explained above, since the use of WAPSs is expected to lower ship's fuel consumption, the ship emits less GHG emissions but also other air pollutants (SO<sub>x</sub>, NO<sub>x</sub>, PM, etc.). The amount of air pollution that is reduced depends on how much less fuel is burned, the sulphur content of the fuel and the type of the engine powering the ship.

### 2.2.3 Other Environmental Impacts

Aside from a reduction of GHG emissions and air pollution, WAPSs potentially can contribute to less underwater radiated noise from the ships on which the systems are installed.

The primary source of underwater noise from ships is the propeller. The reduction in the speed of ships is an operational measure to reduce shipping noise, which can potentially lead to a significant reduction in the noise produced by ships (CE Delft, 2022). Reducing the load of the engine of a ship while using wind power to replace the engine power, can be expected to have the same effect on underwater radiated noise as a reduction of the ship speed. Underwater radiated noise has a negative impact on the marine environment and, since sound propagates four times faster and travels much longer distances in water than in air, such noise can affect animals that are many kilometres away from the noise source (DNV, 2021).

<sup>6</sup> It is likely that the kite is no longer installed on this vessel.

<sup>7</sup> It is unknown whether the kite is still installed on this vessel.

## 2.2.4 Sustainability Conclusions

WAPs can be used to supplement main engine power with wind power, thereby lowering fuel consumption. This can contribute to lower GHG emissions (and other air emissions) and underwater radiated noise.

Just how much fuel consumption can be reduced depends on several factors, ranging from WAP characteristics (e.g., type, number and dimension of units) and ship characteristics, to operational (WAP and ship related) and environmental factors, making it difficult to pinpoint a general effectiveness of a WAP. As an example, some technologies perform better at lower vessel's speed (hard sail and suction wing) while other technologies (rotor sail and kite) perform better at higher vessel speed.

In this study, publicly available results from numerical simulations and measurements, assessing the fuel and emission reduction potential from WAPs, have been gathered. As an example, rotor sails, which is the technology with the most available data, have been found to reveal up to 30% savings. More limited data are available on the performance of the other WAP technologies, also presented in this study.

It has been observed that the variation on the estimated/measured savings is quite significant and the results may not always be compared since different assumptions/conditions may have been considered. To facilitate decision making, any comparison should be made on the same basis. To enhance the accuracy and the validity of the results, ship and WAP specific information should be considered, as well as vessel's intended operational profile and routes, together with the weather data expected to be encountered.

## 2.3 Suitability

WAPs differ in terms of the suitability for the different ship segments. Not all WAP can be installed on every ship segment, however for most ships types at least one type of WAP can be considered suitable. Which technology suits a particular vessel depends on the characteristics of the vessel (size, type, etc.) and the WAP itself.

### 2.3.1 Weight of Technologies

WAP installation increases ship's lightweight. To keep the displacement constant, the deadweight (DWT) is decreased. In other words, the maximum cargo-carrying capacity of the ship is reduced. Hence, for smaller vessels and for vessels where the extra weight might be an important factor (e.g., bulk carriers which are fully loaded when transferring cargo), the weight of the different systems may play a role in selecting the appropriate WAP, as this may result in a loss of revenue.

In the table below, typical weights of different WAP technologies are listed. These weight indications suggest that (depending on the number of units) the weight of the systems is not expected to greatly reduce the cargo-carrying capacity of larger vessels. Only for smaller vessels (<5,000 DWT) is it likely that the cargo-carrying capacity is reduced by more than 1% per WAP unit installed. In this context, larger systems are typically installed on larger vessels.

It is also observed that kites are by far the lightest WAP and as such, their impact on the ship's cargo-carrying capacity is negligible. Rotor sails, on the other hand, are generally one of the heavier systems. However, since these are typically installed on bigger vessels, their weight would be relatively small compared to the DWT of the ship, but of course, the end result depends on the DWT of the specific ship. A way to overcome any potential issue is to install less units.

The weight indications shown in the table below includes the weight of the foundation. Especially for rotor sails, the weight of the foundation is a significant portion of the total weight, roughly 30%. Similarly, for suction wings,

a big part of the weight is at the lower part of the unit. This is not the case for sails. Their weight is more evenly distributed, and for this reason, their impact on vessel's vertical centre of gravity may be more significant, affecting ship's stability (see also subsection 3.1.1).

Table 4. Typical weights and dimensions for different wind propulsion technologies.

Technology	Height (m)	Diameter (m)	Weight (t)
Suction wing	17-26	3-6	15-55
Hard sail	28-50	10-20	45-100
Rotor sail	18-35	4-5	34-90
Kite	surface area: 300-1,000 m <sup>2</sup>		<1

Sources: bound4blue (2023), Econowind<sup>8</sup>, Norsepower<sup>9</sup>, (WASP, n.d.).

Note: The dimensions are given per unit and the maximum values refer to systems that would be installed on large (>100,000 DWT) vessels.

The potential loss in cargo-carrying capacity from WAPS installation is expected to be significantly lower, compared that of alternative fuels, especially compared to hydrogen or methane.

### 2.3.2 Ship's Structure

The ship's structure must be able to support both the weight of the system and the additional forces that the system imposes on the ship. WAPS are typically installed on the deck and some level of reinforcement may be necessary. The size and costs of such reinforcement depend partly on the size and weight of the system that is to be installed, but it also depends on the type of vessel and the technical characteristics of the existing deck structures.

System weight aside, the structure of the installation needs to withstand the forces that are generated by the WAPS, in particular the thrust-generating forces from the wind. For example, hard sails produce thrust because the wind applies significant force to the sail. Hence, the sail's installation on the deck must be strong enough to safely and efficiently capture these forces.

This is also of consideration for kites, albeit in a slightly different way. The structure of the kite attachment to the ship must be able to safely transmit the forces generated onto the ship.

The above challenges are especially important for retrofitted systems, which represent a significant part of the current market (refer to Table 2). It is concluded that while some further studies may be needed, such additional reinforcements do not present insurmountable technical or financial barrier to the adoption of WAPS.

### 2.3.3 Placement Criteria

The suitability and placement of a WAPS on a ship needs to consider issues such as bridge visibility, stability and the systems' operability. While these concerns may vary in significance across the different ship types, the main placement criteria are listed below.

#### Visibility

<sup>8</sup> <https://www.econowind.nl/>

<sup>9</sup> <https://www.norsepower.com/>

Table 4 (above) provides the dimensions of the various WAPS. For taller and wider systems such as hard sails, the optimal placement of the sails is crucial to ensure that the WAPS does not hamper bridge visibility.

With the bridge on passenger ships being at the fore, visibility considerations seem to be more important for cargo ships, as the position of the bridge is at the aft. To circumvent this problem, sails can be exclusively installed on one side of the deck, or at the centre line in a series so that there is only one direction that is blinded. Also, the number of systems installed can be limited to reduce the negative impact on visibility.

In cases where a kite is installed on a towing tug, bow visibility does not play a role on the ship being towed.

To address any obstruction to the navigational lights, a second light mast may be installed to compensate for the impact of the WAPS.

### **Stability**

The placement of a wind propulsion system can influence the stability of the ship by increasing her vertical centre of gravity (Haripriyono, Yaseen, & Hannan, 2021). However, this effect on ship's stability is not considered significant when the weight of the systems is much less than the total displacement. The wind force due to WAPS operation is also expected to affect the stability (see also subsection 3.1.1). This force depends on the WAPS type, the number of units and the dimensions.

Many of the market's current systems can be folded or tilted to be turned down at high wind speeds to prevent the ship's stability from coming into danger. For relatively small vessels, systems with adequately small dimensions might not be available, though demonstrators are often developed to be tested on relatively small vessels. The structure of the vessel may need to be modified, e.g., by reducing number of decks or increasing vessel's beam, to ensure that stability criteria are maintained.

At the same time, some installations have been proven to reduce a vessel's motion (improving stabilisation), making the experience more comfortable for passengers. This can be explained by the increased vertical centre of gravity which has a dampening effect on roll motion: when the wind crosses the beam (e.g., from port side), in the roll motion, the roll back to the port side is dampened.

### **Operability**

WAPS should not interfere with the operability of the ship, such as the loading or unloading of cargo. On-deck cranes (e.g., on bulk carriers, general cargo ships or tankers), as well as cranes and other machinery on the dock should freely operate and should not be obstructed by the presence of WAPS.

There are several solutions for this. For example, systems can exclusively be installed on one side of the ship, allowing the other side to be freely used to transfer cargo. Any tiltable or foldable systems can be used while dockside to offer more flexibility. Such flexible systems are also convenient and reduce the potential interference with land-based infrastructure (e.g., bridges).

Moreover, some wind-technology providers offer movable systems, which can be moved on a rail to either side of the ship.

### **Vibrations**

Systems which may create vibrations, such as rotor sails, should be placed to avoid creating a nuisance next to cabins.

## **2.3.4 Other factors**

While the weight, the structure and the placement criteria are crucial, there are several other factors that could play a role in selecting a specific system for a specific vessel.

## Ship size

Larger ships typically need more propulsion power. At the same time, they offer the possibility for installing bigger systems (e.g., larger sails/wings, or taller rotor sails), or multiple rotor sails/sails/wings.

Implementation of WAPs on the smallest vessels can be challenging in terms of space and stability. For example, suction wings are only efficient at heights of roughly 10 m or above. However, suction wings have been successfully installed on a fishing vessel. For rotor sails, given their size and weight, manufacturers believe that ships smaller than 80 m in length are not particularly well suited.

## Deck space

For rotor sails, hard/soft sails and suction wings adequate deck space needs to be available for installation. In contrast, kites do not require deck space. As such, kite technologies, in principle, can be applied to any ship type, provided the bow has adequate space for installation, and they do not compromise the visibility from the bridge.

The availability of deck space not only depends on the ship size, but also on the type of ship.

Flat-decked general cargo ships and bulk carriers often have enough space on deck to make them well suited for installing a WAP. Table 5 (below) shows most of the systems have been installed on those types of ships.

As bulk carriers are generally large ships with ample deck space, multiple systems can be installed and different constellations of rotor, hard sails and suction wings are feasible, considering the location of the hatches. Some WAPs are installed between the hatches on the centre line (some of which can be moved to starboard or portside for cargo operations) while others are installed on starboard and/or portside (some of which can be moved along the side); a single unit can also be installed at the bow.

General cargo ships are often equipped with a single unit or set of WAPs on the stern or bow of the ship in configurations that allow most the deck to remain free. Also, the owners of multiple bulk carriers have recently opted for their ships to be equipped with kites.

A considerable number of WAPs also have been installed on Ro-Ro vessels and tankers. Like bulk carriers and general cargo ships, these types of ships generally have ample space on deck. Two passenger ships (ferries) have been equipped with rotor sails. Although deck space is available on passenger ships, they generally offer less than cargo ships. At the same time, on those vessels, moving objects on deck, such as kites, might be considered a risk for passengers.

WAPs have yet to be installed on a container ship, for which the lack of deck space is a key issue. However, an Approval in Principle has been awarded to install eight wing sails on an 1,800 TEU (Bureau Veritas, 2021). Also, in 2022 ABS granted another Approval in Principle for a wind powered container carrier with three masts spreading almost 3,200 m<sup>2</sup> of sail area (soft sails) and a hydrogen (H<sub>2</sub>) fuel cell assisted propulsion system with a capacity of 152 TEUs. Plans also exist to equip a container feeder ship with suction wings mounted on a container (IWSA, 2023).

Table 5. Number of ships with installed (and plans to install) WAPs and average number of units, per ship type.

Ship type	Number of ships	Average number of systems per ship
Bulk Carrier	17	3
General cargo	10	2
Ro-Ro	8	2
Tanker	4	3
Ferry	2	1

Ship type	Number of ships	Average number of systems per ship
Gas carrier	2	1
Cruise/yacht	2	3
Other	6	3

### Fire safety

When a system is installed on an oil and chemical tanker, extra safety measures for electricity connections should be taken. For instance, it may be necessary to install an earth grounding and address any potential risks of explosion that electrical equipment present. Ultimately, these and other safety requirements may further constrain the placement options on these types of vessels.

Many ATEX-compliant technologies, which are certified for use in environments where explosions are considered a risk, are currently available, making them suitable for tankers.

### Helicopter decks

Extra safety issues are caused by helicopter decks, which are increasingly common on some types of passenger ships. During the approach of a helicopter, a rotor, for example, would need to be completely stopped to minimise the risk of forces that could impact the course or manoeuvring of the aircraft. Lights on the WAPS also would need to be installed for night landings.

### Propeller

Finally, WAPS may be considered in combination with controllable pitch propellers, which enables the vessel to operate in a larger range of operating conditions and engine loads without cavitation issues; this could improve performance. Reducing the speed of a ship equipped with controllable pitch propellers, however, does not necessarily result in a reduction of underwater radiated noise.

In case of retrofitting a WAPS on a vessel the above should be optimised as far as practicable and in accordance with existing rules and regulations. On the other hand, new ships have the advantage that they can address many of these challenges at the planning stage with more flexibility.

## 2.3.5 Suitability Conclusions

There are several factors to be taken into account before installing a WAPS onboard. The type, number and size of units, and location of the WAPS need to be carefully selected while there are several particularities to be considered for the various ship types.

For rotor sails hard/soft sails and suction wings adequate deck space needs to be available for installation. The availability of deck space depends on the ship size and type. Bulk carriers, flat-decked general cargo ships, tankers and gas carriers are the most promising ship types in this respect; Ro-Ro and passenger ships (Ro-Pax, cruise ships and ferries) also have potential to apply the systems. However, passenger ships can be expected to have relatively less deck space.

For ships with little deck space, like traditional container ship designs, a kite or an innovative solution such as using towing tugs equipped with WAPS could be considered as alternative options. Also, containerised WAPSs have been developed.

To avoid interference with cargo handling and on land infrastructure, as well as to avoid undesired effects at high wind speeds, most systems are currently designed to be flexible (e.g., foldable or tiltable).

The weight of the units varies significantly among the different types of WAPSs. The weight of the system could, in principle, reduce the cargo-carrying capacity of a ship. Only for smaller vessels (<5,000 DWT) it is likely that the cargo-carrying capacity per WAPS unit would be reduced in orders of magnitude larger than one percent. For bigger vessels, the reduction in cargo-carrying capacity is even less significant.

The ship structure should allow a safe transmittance of the forces generated by the WAPS onto the ship, so some reinforcement may be needed. The fact that most current installations of WAPS are retrofits, indicates that this does not present insurmountable technical or financial barriers.

Passenger and crew comfort and safety, vessel's stability and obstruction to bridge visibility are other issues that needs to be considered when placing a WAPS.

## 2.4 Availability

### 2.4.1 Availability of Wind

Naturally, all WAPS technologies need wind energy in order to produce thrust. Hence, the availability of wind on sailing routes is of paramount importance when considering the efficiency of WAPS.

In general, a higher wind speed leads to larger energy output from a WAPS, resulting in higher fuel savings. Nevertheless, higher wind speeds are usually accompanied by larger waves, which in fact decreases the ships' performance due to increased wave resistance (Chou, Kosmas, Acciaro, & Renken, 2021). In addition, safety considerations may prompt decisions to limit the capacity of these technologies when wind speeds are too high. Some technologies, such as (foldable) hard sails and suction wings, are often not used in inclement weather.

Several data models calculate the savings of WAPS systems by considering the availability of wind on certain routes. Wind data sets are available to this end; for example, the dataset which provides historical global wind data at 10 m height for a 0.25°x 0.25° resolution. [ERA5](#) dataset provides historical global wind data at 10 m height for a 0.25°x 0.25° resolution.

Also, the IMO has published a global wind-probability matrix, which takes a statistical approach, providing probabilities for apparent wind speeds and angles along the main global trading routes. These data can be used in models that calculate fuel savings without reference to specific routes. In Figure 9, the routes being considered are illustrated.



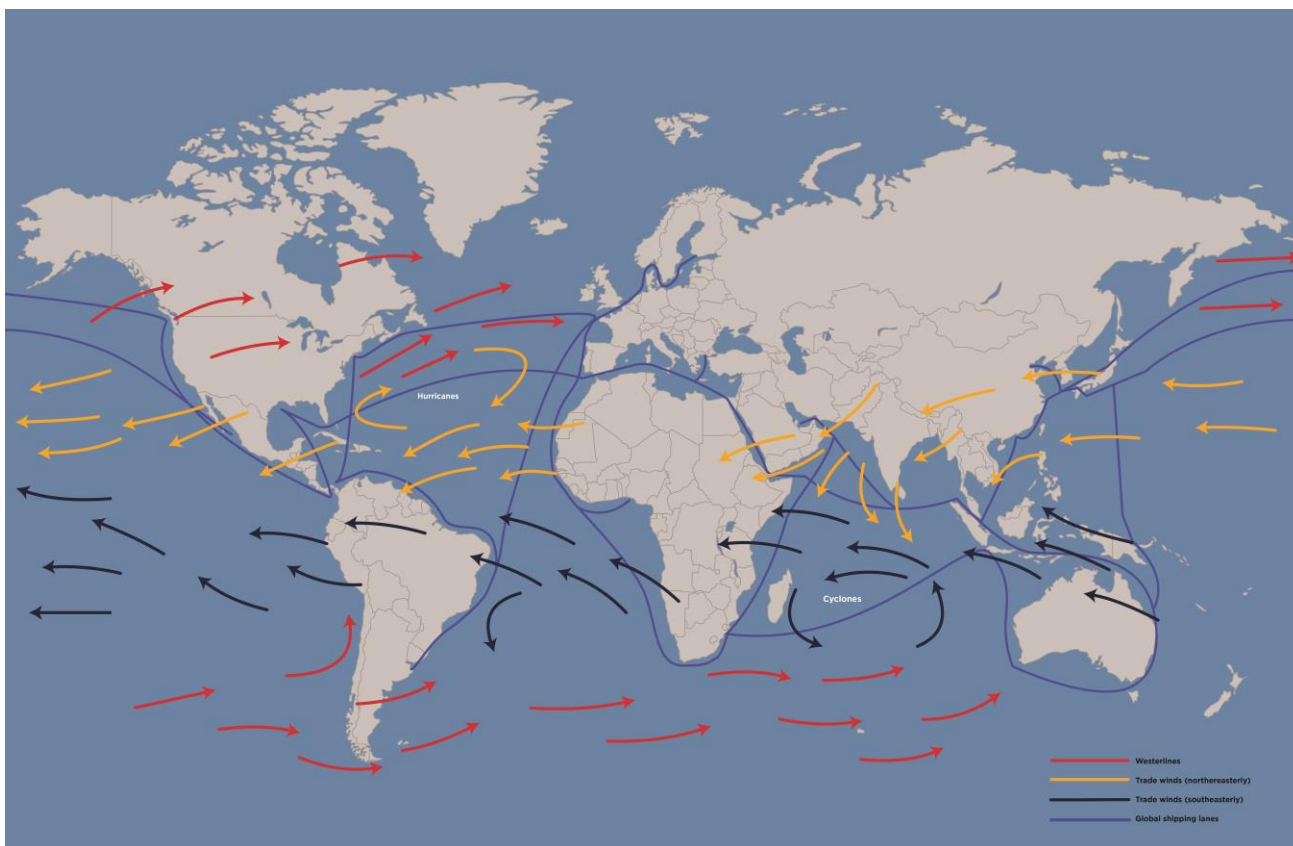

Figure 9. The global trade routes taken into account for wind probabilities in the IMO Global wind-probability matrix as per (MEPC.1-Circ.896) together with qualitative illustration of the trade winds and westerlies (What Are Trade Winds? | NOAA SciJinks – All About Weather).

From the IMO Global Wind matrix, the probability distribution for apparent wind speed and apparent wind angle can be derived (as illustrated in Figure 10). These distributions represent the probability of encountering certain wind speeds and angles on average on the global trade routes. From these figures, it becomes clear that, generally, headwind or tailwind is expected to occur with a higher probability than crosswinds. On average, apparent wind speeds of 5-8m per second are the most likely on the global trade routes.

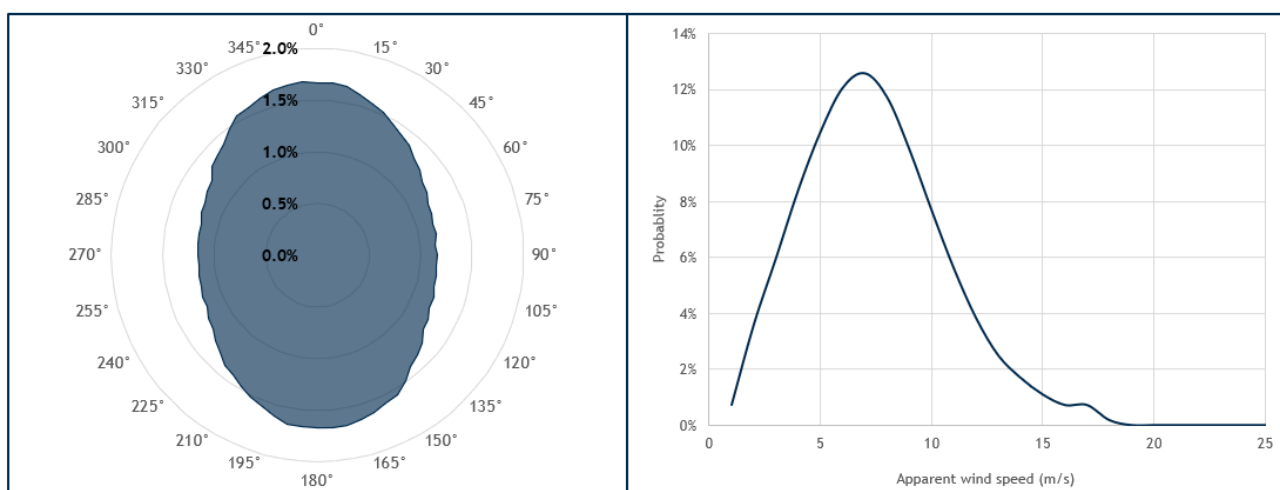

Figure 10. The average probability distributions of apparent wind angle (left) and speed (right) on the global trade routes based on MEPC.1-Circ.896 data.

However, the statistics on global wind conditions ignore the differences that exist between different trade routes. The global trade routes (depicted in Figure 9) span different oceans, longitudes and latitudes, which causes the average wind statistics for each route to vary. One of the main influencing factors on the average wind conditions are the globally prevailing winds, known as the trade winds and westerlies (an illustration of the direction of these winds is given in Figure 9. The global trade routes taken into account for wind probabilities in the IMO Global wind-probability matrix as per (MEPC.1-Circ.896) together with qualitative illustration of the trade winds and westerlies (What Are Trade Winds? | NOAA SciJinks – All About Weather). Around the equator, the prevailing wind direction is eastwards (trade winds), while on the middle latitudes the prevailing wind direction is westwards (westerlies).

Depending on the trade routes, these trade winds have major effects on the efficiency of wind propulsion systems. Moreover, because of the prevailing direction of trade winds at given latitudes, the efficiency of wind propulsion can be significantly different when navigating the same ocean in the opposite direction (Kaneko & Tsujimoto, 2021). For example, this is significant on the trans-Atlantic trade route.

This phenomenon is illustrated in Figure 11. Because the prevailing wind direction in the northern hemisphere is eastwards, a voyage from Rotterdam to New York mostly will face headwinds, which results in net negative fuel savings in the simulation data below. When travelling in the opposite direction, the wind direction during the voyage is mostly a tailwind, which results in positive net fuel savings.

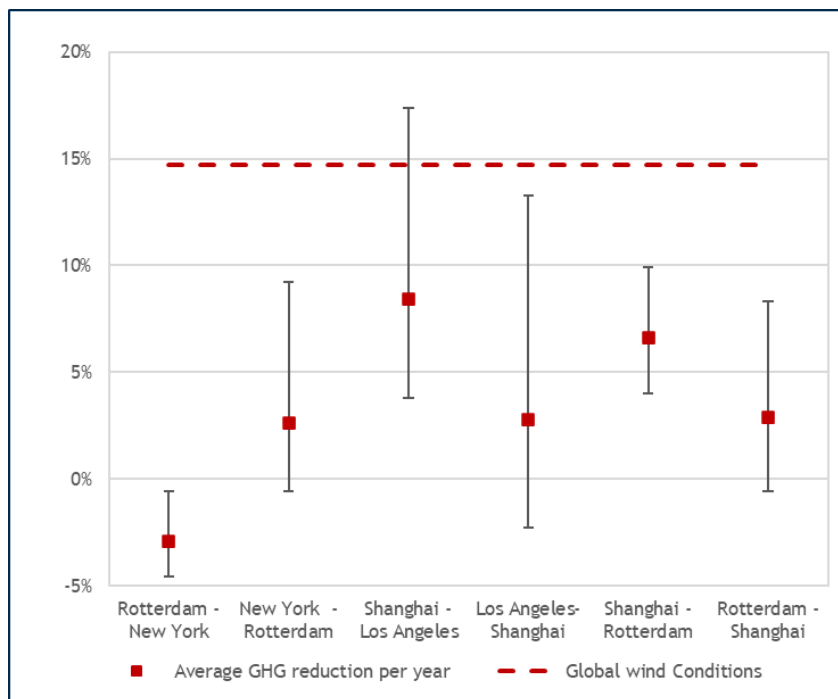

Figure 11. Differences in GHG reduction (averaged per year) for direction of voyage, for different trade routes. Simulation data was obtained for a Capesize bulker (45000 MT DWT) with 4 rotor sails (4m×28m), sailing at 12 knots. Data from Lloyd’s Register (2020).

In general, wind can be expected to be more available on the open ocean than on seas surrounded by land, such as the Mediterranean or the Baltic Sea; availability is lowest in coastal areas. Therefore, for small ships, which can be expected to sail relatively often in coastal areas, WAPS may be a less attractive. The dimensions of the units that the technology providers are offering or intend to offer also focus mainly on medium- and large-sized ships, while prototypes are naturally smaller and tested on relatively smaller vessels.

Furthermore, as Figure 12 illustrates, the availability of wind varies greatly across the seasons (NASA, 2008).

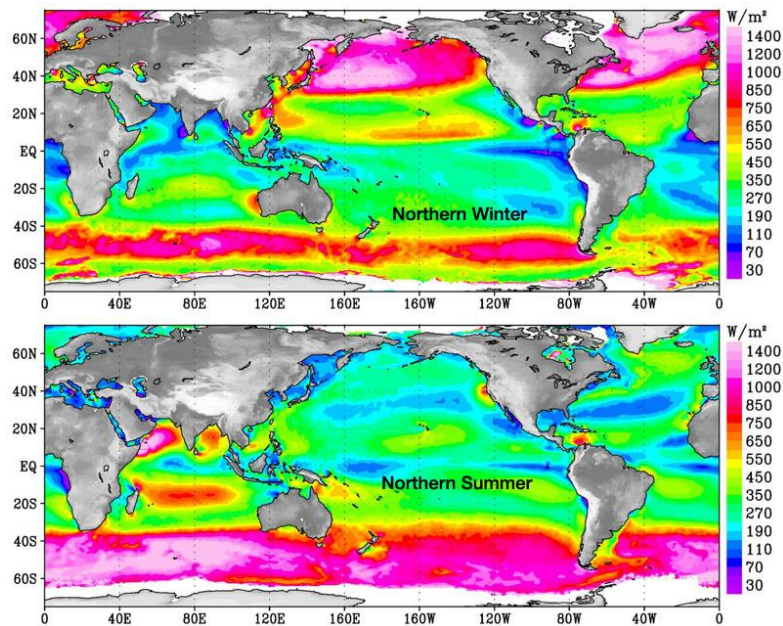

Figure 12. Wind power density over global oceans for winter (top panel) and summer (lower panel). Source: (NASA/JPL, 2008).

Finally, the optimal wind conditions, in terms of wind angle and speed, also differ between the different WAPS, which makes it difficult to identify routes which are, in general, particularly well-suited for WAPSs. However, it can be expected that WAPS technology providers do select favourable routes for testing the technology, and that the adopters of the technologies also will operate on favourable routes. So initially, this may make it easier to identify some of the favourable routes for the different WAPS technologies.

For example, the route between Gedser (DK) to the north and Rostock (GER) to the south is almost perpendicular to the prevailing wind from the west (or a little less frequently east). Since a rotor has an optimum effect when there is a wind blowing a little abaft (towards the stern) abeam and perpendicular to the rotor, the technology provider considers this crossing to have favourable conditions for its use (Moore, 2022).

### Voyage optimisation

To maximise the profit from a WAPS, ships may alter their sailing routes to attain favourable wind directions and speeds. According (Smith, Newton, Winn, & Grech La Rosa, 2013), fuel savings could significantly increase (5-10%) when ships deviate from the [Great Circle route](#). Other studies argue for even higher increases in fuel savings (Bentin, et al., 2016). A simulation study (NAPA, Norsepower & Sumitomo, 2013) which built on performance data analysed the reduction potential of rotor sails installed on a tanker, depending on whether voyage optimisation was applied. For the six trading routes analysed, it was concluded that about 10% of the 19% in CO<sub>2</sub> reduction (i.e., 1.9% of the reduction) could be ascribed to the use of voyage optimisation.

Since the conventional route is usually the shortest, a trade-off occurs between the efficiency of the WAPS system and the increase in the length of the route. For example, a sailing route can be altered such that the thrust from the WAPS is increased by 10%. However, if the total length of the journey also increases by 15%, only 3.5% of fuel is saved compared to the original journey.

In other words, an equilibrium between fuel savings and journey length must be found to maximise the profit from installing a WAPS. Routes also may need to be altered if the air draft of the vessel<sup>10</sup> increases due to the WAPS. In this case, land-based infrastructure such as bridges might become an obstacle if the WAPS is not stowable or foldable.

<sup>10</sup> Distance from the surface of the water to the highest point on a vessel.

However, it is noted that the resulting elongation of voyages may negatively impact vessel's annual revenue over the year since less cargo may be transported. Additionally, in case of vessels under long-term chartering agreements, the charterer's consent would be needed for such deviations and relevant time charter clauses should be available.

Crew training will be required not only to ensure that the WAPS is correctly and optimally used; training also will raise awareness about voyage optimisation in terms of route selection and on-route voyage adaptation. This is of paramount importance when the WAPS is not fully automated.

## 2.4.2 Availability of WAPS

The greater production of WAPS is a prerequisite for such system to contribute significantly in reducing the emissions from shipping.

The current production capacity of technology providers varies greatly and, in the short run, there even may be a shortage of available systems. In the medium- and long-terms, however, expanding production is not considered a barrier to the use of WAPS.

As an example, one technology provider was able to secure two loans to build- and scale-up production capacity in Asia ( (Norsepower, 2023a), (Norsepower, 2023b)). Another provider of suction wings, recently mentioned in an interview<sup>11</sup> a goal to double the production annually, starting from about 10 units. It was also explained that once the demand picks up, the licenced production is expected to allow for a relatively fast increase in production capacity.

## 2.4.3 Availability Conclusions

The present availability of WAPS is potentially only a short-term barrier to their wider adoption by the maritime shipping sector.

The efficiency of WAPs is largely dependent on the availability of wind on the routes being sailed. This, in turn, depends significantly on the specific route, the route direction, the seasonal variations and the proximity of the water to land. Wind angles relative to the speed are also crucial. To gain maximum efficiency from wind propulsion systems, trade routes might have to be adjusted to find a perfect balance between available wind and route length. Voyage (route) optimisation systems are considered of paramount importance in this context. However, for vessels with fixed routes and schedules, such as ferries or container ships, this might not be an option.

Deployment of vessels with WAPS to specific trading areas with more beneficial wind speed and direction could be considered.

## 2.5 Techno-Economical Analysis

### 2.5.1 Introduction

The use of WAPS is associated with different costs and benefits. In the following paragraphs, the different cost elements as well as the economic benefits are presented and explained, from the perspective of shipowners/ship operators<sup>12</sup>.

---

<sup>11</sup> The interview was carried out for the purpose of this study.

<sup>12</sup> While some cost components may in practice be passed on to the charterer (e.g., fuel cost, carbon cost), the aim here is to present a complete overview of all cost components related to WAPS.

### *Capital expenditure*

Capital expenditure (CAPEX) includes the cost of the asset (purchase cost of WAPS) and the installation cost.

The cost of the asset depends on the type of WAPS, the number and the dimensions of the units being installed.

The installation cost includes engineering costs, material costs (e.g., for foundations and deck reinforcement), labour costs (e.g., for preparation and welding), logistics costs, as well as potential costs related to the time required for the installation. Installation costs may vary not only depending on the number of WAPS units, but also on their dimensions, as well as location and timing. In more detail, cranes are required, which might be readily available at the location of installation (e.g., at the shipyard) or may need to be ordered and transported (mobile crane). The WAPS itself may also need to be transported to the location of installation. The aforementioned transportation elements may potentially increase the costs. Labour costs also differ depending on the location.

Installation costs have a fixed (independent of number of WAPS) and a variable cost component (dependent on number of WAPS). In some cases, installation costs can also be ship type specific. As an example, for tankers higher safety standards may apply, which could potentially lead to higher retrofit costs.

As Table 2 (see subsection 2.1.2) illustrates, each type of WAPS is in principle suited for retrofitting. Some of the cost elements are expected to be higher for a retrofit project compared to a newbuilding, including the setup of the staging in a cargo hold/tank to reach the underdeck area, steel work required for the foundation, as well as the additional amount of labour for mobilisation of equipment, surface preparation, welding, and other preparatory works. Some revenue losses may also occur associated with off-hire days for retrofit projects (in case the installation is not carried out within the scheduled dry-docking time frame).

Regarding the engineering costs for newbuildings, given that the yards are typically working with standardised designs for commercial vessels, any modification upon request is associated with an additional cost for the owner. However, such costs may also end up being quite small per ship installation, since these designs are often repeated, and thus the cost is expected to be split among many projects. On the other hand, for one-off projects (including retrofits), this cost is expected to be higher since the design will need to be evaluated on a case by case and tailor-made solutions should be found.

Despite the uncertainty, the retrofit costs can be expected to be considerably lower than those for adapting the ship to use alternative fuels such as ammonia or hydrogen.

### *Other one-off costs*

Aside from CAPEX, one-off costs will also be accrued for crew training. The crew will need to learn how to operate and maintain the WAPS. They will also need to gain practical understanding on how to operate the system so that they can maximise the potential to reduce fuel consumption. Costs for crew training can be expected to be low compared to the CAPEX of the WAPS but are, in most cases, considered crucial for the effective use of the system. For example, a rotor sail provider (Norsepower, 2018) offers a training for crew and technical superintendents which is a one-day training, while a suction wing provider (bound4blue, 2023) stresses that due to the autonomous control system no additional workload for the crew accrues and no additional training is required. If voyage optimisation software/service is used, in some cases this could be part of the CAPEX.

### *Operational expenditure*

There are different costs associated with the use of WAPS on board ships that are incurred regularly, including maintenance and repair costs and those associated with their operation. Some WAPSs are dynamic, actively moving to produce the desired effect, while some are flexible (e.g., foldable or retractable). Both require energy; thus, they also incur additional fuel and/or energy expenditures.



Compared to the baseline (no WAPS), a potential elongation of voyages to meet more favourable wind conditions might lead to less cargo transported during the year leading to loss of revenue. If voyage optimisation software/service is used, this may lead to some annual subscription fees.

In other instances, an extra crew member may need to be recruited to operate this solution, leading to higher OPEX. Similarly, the expenditures will rise if a ship makes use of a towing service provided by a kite-equipped tug, while no other costs apply in this case.

#### *Economic benefits*

If a WAPS is used to reduce the main engine power, the fuel expenditure will decrease. In case of diesel-electric propulsion systems, some generators may be switched off, while the rest can still be operated at their optimal design point, while other types of engines may have to operate at non-optimal loads, reducing slightly the fuel savings. Additionally, a reduction of fuel consumption might contribute to a lower frequency of bunkering, or a reduction of the time required per bunkering instance. On new buildings opting to include WAPS, less engine power could be installed, reducing the main engine CAPEX.

## 2.5.2 Modelling Approach

### *General approach*

As a first step, the annual additional costs (compared to the base case - vessel without WAPS) for installing and operating WAPS are considered, i.e., additional OPEX and CAPEX and other one-off costs, converted into annual costs, assuming a weighted average cost of capital of 7%<sup>13</sup> and installment payments over 15 years.

As a second step, the relative annual fuel savings, that would be required from the main engine (and would be materialised by substituting part of the main engine power with wind power) to cover the annual costs as determined in step one, are calculated for 2021<sup>14</sup>, 2030 and 2050.

Below, the underlying assumptions used in the analysis are described in more detail:

### *Number and size of units*

While there is no rule for WAPS application, for this analysis, it is assumed that the use of WAPS might be less common for small vessels (<5,000 DWT). These vessels can be expected to sail mainly in coastal areas where wind conditions are less attractive, while the dimensions of the existing WAPS might be less suitable for them. Therefore, these have not been considered.

It is assumed that relatively small cargo ships will install one relatively small unit, medium-sized ships will install two medium-sized units and that the largest ships (>100,000 DWT) will install four large units. For passenger vessels, which have less deck space than cargo ships of the same size, the installation of maximum two units has been assumed.

Currently, it is observed that while rotor sails, hard sails and kites have been installed on ships above 100,000 DWT (refer to Table 2) suction wings have not. However, this is expected to change once the dimensions of suction-wings grow to the sizes required by larger vessels and become available. In this analysis, it has been assumed that WAPS are installed on large vessels independent of the type. The costs for the largest dimension of some of the WAPS may, however, not reflect the costs for dimensions that might become available in the future.

---

<sup>13</sup> A representative WACC has been considered based on the ranges used by several shipping companies (Hapag-Lloyd 7.7%-10.1%; Yang Ming Marine Transport 6.4%-8.3%; Moller-Maersk 7.8%, Scorpio Tankers 5.2%, Western Bulk Chartering 7.2%, Eagle Bulk Shipping 7.4%).

<sup>14</sup> Despite the fact that the study was published in 2023, 2021 has been considered for consistency with the previous studies published under the same contract with EMSA.

Table 6 (below) gives an overview of the number and size of the WAPS units anticipated to be installed on each segment.

Table 6. Ship type and size categories and the number and dimension\* of WAPS units assumed to be installed.

Ship type	Size category	Unit	Rotor sails, Suction wings Hard sails*	Kites*
Bulk carriers	0-9,999	DWT	0	0
	10,000-34,999	DWT	1	1
	35,000-59,999	DWT	1	1
	60,000-99,999	DWT	2	1
	100,000-199,999	DWT	4	1
	200,000-+	DWT	4	1
Chemical tankers	0-4,999	DWT	0	0
	5,000-9,999	DWT	1	1
	10,000-19,999	DWT	1	1
	20,000-39,999	DWT	1	1
	40,000-+	DWT	2	1
Container ships	0-999	TEU	0	0
	1,000-1,999	TEU	0	1
	2,000-2,999	TEU	0	1
	3,000-4,999	TEU	0	1
	5,000-7,999	TEU	0	1
	8,000-11,999	TEU	0	1
	12,000-14,499	TEU	0	1
	14,500-19,999	TEU	0	1
	20,000-+	TEU	0	1
General cargo ships	0-4,999	DWT	0	0
	5,000-9,999	DWT	1	1
	10,000-19,999	DWT	1	1
	20,000-+	DWT	2	1
Liquefied gas tankers	0-49,999		0	0
	50,000-99,999	cbm	1	1
	100,000-199,999	cbm	2	1
	200,000-+	cbm	4	1
Oil tankers	0-4,999	DWT	0	0



Ship type	Size category	Unit	Rotor sails, Suction wings Hard sails*	Kites*
	5,000-9,999	DWT	1	1
	10,000-19,999	DWT	1	1
	20,000-59,999	DWT	2	1
	60,000-79,999	DWT	2	1
	80,000-119,999	DWT	2	1
	120,000-199,999	DWT	4	1
	200,000-+	DWT	4	1
Other liquid tankers	0-999	DWT	0	0
	1,000-+	DWT	0	0
Ferry-pax only	0-299	GT	0	0
	300-999	GT	0	0
	1,000-1,999	GT	0	0
	2,000-+	GT	1	0
Cruise ships	0-1,999	GT	0	0
	2,000-9,999	GT	0	0
	10,000-59,999	GT	1	0
	60,000-99,999	GT	1	0
	100,000-149,999	GT	2	0
	150,000-+	GT	2	0
Ferry Ro-Pax	0-1,999	GT	0	0
	2,000-4,999	GT	0	0
	5,000-9,999	GT	1	0
	10,000-19,999	GT	1	0
	20,000-+	GT	1	0
Refrigerated bulk carriers	0-1,999	DWT	0	0
	2,000-5,999	DWT	0	0
	6,000-9,999	DWT	1	1
	10,000-+	DWT	1	1
Ro-Ro	0-4,999	DWT	0	0
	5,000-9,999	DWT	1	1
	10,000-14,999	DWT	1	1
	15,000-+	DWT	2	1
	0-29,999	GT	0	0

Ship type	Size category	Unit	Rotor sails, Suction wings Hard sails*	Kites*
Vehicle carriers	30,000-49,999	GT	1	1
	50,000+	GT	1	1

\*Smallest dimension indicated in blue, medium dimension in purple and largest in green.

### Estimation of costs

Cost data for WAPS is rather uncertain since data is hardly publicly available and technology providers are reluctant to provide business sensitive data.

For this analysis, cost estimates are applied based on literature (mainly IMO's 4<sup>th</sup> Greenhouse Gas Study and (Schenker, 2007)) and interviews conducted by the project team with technology providers<sup>15</sup>. Data availability for rotor sails and suction wings is better and can therefore be considered more reliable.

Table 7 (below) offers single-unit estimates for the CAPEX (asset and installation cost) and OPEX for different wind propulsion technologies. A minimum and maximum value is given. The minimum value relates to units with small dimensions expected to be installed on smaller ships, while the maximum is for large units expected to be installed on larger vessels. The following have been assumed:

- The cost of the assets varies depending on the technology and dimension. For kites, only one unit per ship is expected to be installed, whereas large vessels can be equipped with multiple rotor sails, suction wings, or hard sails. In other words, kite costs represent the total costs, while the listed costs for other systems will need to be multiplied by the number of systems installed. The cost of the assets is assumed to decrease over time due to economies of scale – 2030 and 2050 costs are assumed to be 10% and 20% lower than current costs, respectively.
- Indicative installation costs have been assumed for a newbuilding (15% of asset costs). The additional costs for a retrofit are rather uncertain. As suggested by one technology provider, an additional 10% has been assumed, as a rule of thumb.
- This analysis does not consider the potential loss of revenue due to off-hire days in case of a retrofit.
- Costs associated with voyage optimization software/service have not been accounted for.
- An indicative training cost has been assumed equal to EUR 10,000, independent of the WAPS technology and number of units.
- The OPEX are yearly recurring costs. Costs for maintenance & repair are assumed to stay constant over time and to be 5% of the 2021 CAPEX for kites<sup>16</sup> and 2% of the 2021 CAPEX for all other technologies. For rotors and suction wings, the energy consumption is estimated based on the technology providers' specifications of the additional power to be installed per unit<sup>17</sup>. For hard sails kites such information is not available which is why these costs have not been accounted for. For hard sails – being a passive WAP – power consumption is probably negligible. However, for some kite systems, power consumption may not be negligible.

<sup>15</sup> One rotor sails and two suction wing providers provided high level input during interviews.

<sup>16</sup> Wear and tear can be expected to be relatively high for kites, but no specific data on the actual life time of kites is available.

<sup>17</sup> It has been assumed that the systems are used for one third of the year, with a SFOC equal to 215 g/kWh.

Table 7. 2021 cost indications for a single unit WAPS, depending on dimension.

	WASP	Rotor sail		Suction wing		Hard sail		Kite	
	Costs (EUR 1,000)	min	max	min	max	min	max	min	max
CAPEX	Asset costs	560	1,050	200	900	438	876	340	2,345
	Installation costs (newbuild)	84	158	30	135	66	130	51	351
	Installation costs (retrofit)	140	263	50	225	109	219	85	586
One-off costs	Training	10	10	10	10	10	10	10	10
OPEX	Annual maintenance & repair	12	22	4	18	8	18	17	117
	Annual energy consumption WAPS	26	79	26	53	No data available			

\* The per unit installation costs are assumed to amount to a certain percentage of the asset costs, with this percentage being lower for the largest units.

### Fuel expenditure savings

To calculate the savings in fuel expenses, the average energy consumption of the different ship types/sizes (64 categories<sup>18</sup>) is taken from the 4<sup>th</sup> IMO GHG Study (2018). WAPS is only expected to reduce the fuel consumption from the main engine during cruising. To this end, the share of the fuel consumption over the various activities of the ships, as well as the average share of the fuel consumption over the main engines, auxiliary engines and boilers are illustrated in the following two tables.

Table 8. Average distribution of fuel consumption over the activities of the different ship types.

Ship type	Cruising & slow cruising	Manoeuvring & at berth & at anchorage
Bulk carriers	94%	6%
Chemical tankers	77%	23%
Container ships	94%	6%
General cargo ships	79%	21%
Liquefied gas tankers	68%	32%
Oil tankers	81%	19%
Other liquid tankers	89%	11%
Ferry-pax only	91%	9%
Cruise ships	76%	24%
Ferry Ro-Pax	86%	14%
Refrigerated bulk carriers	72%	28%
Ro-Ro	76%	24%
Vehicle carries	82%	18%

Source: 4<sup>th</sup> IMO GHG Study

<sup>18</sup> In the Fourth IMO GHG Study, in total 70 type and size categories are being differentiated. The six categories not considered here are yachts, service vessels (tugs), fishing vessels, offshore vessels, service vessels (other) and miscellaneous vessels.

Table 9. Average distribution of the ship's fuel consumption at sea over MEs, AEs and boilers.

Ship type	Main engine	Auxiliary engines & boiler
Bulk carriers	88%	12%
Chemical tankers	67%	33%
Container ships	86%	14%
General cargo carriers	81%	19%
Liquefied gas tankers	76%	24%
Oil tankers	66%	34%
Other liquid tankers	75%	25%
Ferry-pax only	65%	35%
Cruise ships	48%	52%
Ferry Ro-Pax	77%	23%
Refrigerated bulk carriers	49%	51%
Ro-Ro	73%	27%
Vehicle carriers	89%	11%

Source: 4<sup>th</sup> IMO GHG Study

Combining the above, Table 10 (below) illustrates that the average share of the main-engine fuel consumption is highest for bulk carriers and container ships and lowest for refrigerated-cargo and cruise ships.

Table 10. Average share of ME fuel consumption in total fuel consumption during cruising &amp; slow cruising.

Ship type	Average share ME FC in total FC
Bulk carriers	83%
Chemical tankers	51%
Container ships	81%
General cargo carriers	64%
Liquefied gas tankers	52%
Oil tankers	54%
Other liquid tankers	67%
Ferry-pax only	59%
Cruise ships	36%
Ferry Ro-Pax	66%
Refrigerated bulk carriers	35%
Ro-Ro	56%
Vehicle carriers	73%

Source: 4<sup>th</sup> IMO GHG Study

For the calculation of the fuel expenditure savings, the assumptions in terms of fuel type, fuel price, carbon costs<sup>19</sup> and expected improvements in energy efficiency from the baseline are as presented in the following

<sup>19</sup> Carbon costs are assumed to apply to each litre of VLSFO consumed in 2030. The assumed carbon price is in line with the 2030 carbon price as given in the [Commission's impact assessment](#) for the amendment of the EU Emissions Trading System. If ships also sail on routes where no or lower carbon costs accrue, higher fuel savings will be required to cover the costs associated with the WAPs.

table<sup>20</sup>. To comply with the FuelEU Maritime Directive on 2030, a blend of VLSFO (95%) and biofuel (5%) has been assumed for 2030, as well as a wind reward factor ( $f_{wind}$ ) of 0.97.

Table 11. Additional assumptions to determine fuel expenditure savings.

Parameter	2021	2030	2050
Baseline fuel type	VLSFO	Blend of VLSFO and biofuel (FAME)	Ammonia
Fuel price (excl. carbon costs)	14.6-17.3 EUR/GJ	VLSFO: 10.5-14.6 EUR/GJ FAME: 20.1-26.6 EUR/GJ	29.2-38.0 EUR/GJ
Carbon cost	Not applicable	VLSFO: 3.45 EUR/GJ; Biofuel: 0 EUR/GJ	Green ammonia: 0 EUR/GJ
Efficiency improvement of the ship compared to base year*		20%	20%

\* The average energy efficiency of the ships can be expected to improve over time due to energy efficiency measures and autonomous improvements.

### 2.5.3 Modelling Results

Table 12 (below) provides the relative savings in main engine fuel consumption that would be required to cover the annual extra costs for the WAPS (according to the assumptions described above). The annual extra costs consist of the annuitised CAPEX and annual OPEX. Two scenarios have been assumed for each year, 'Low' and a 'High', with regards to the fuel prices. It is highlighted that for higher fuel prices than those assumed for 2021, 2030 and 2050, which can be expected in the years in between, less fuel savings will be required to cover the costs.

When comparing the outcome among ship types/sizes, it should be considered that a different number and size of WAPS units have been assumed for each segment (see also Table 6). For more and larger units, higher absolute savings are required to cover the costs. However, as the number of units and size of units increases the savings are also expected to increase.

As explained above higher installation costs apply if a WAPS is installed on an existing ship. The results are given for both, applications to newbuilds and retrofits.

Table 12. Range of required ME fuel saving to cover annual additional costs of WAPS – rotor sail - newbuilding.

Ship type	Size category	Unit	Number of units assumed to be installed*	Rotor sail - newbuilding					
				2021		2030		2050	
				Low	High	Low	High	Low	High
Bulk carrier	0-9,999	DWT	0	Not considered					
	10,000-34,999	DWT	1	6.8%	3.8%	6.8%	4.3%	4.4%	3.3%
	35,000-59,999	DWT	1	15.6%	8.7%	15.7%	9.9%	10.7%	8.0%
	60,000-99,999	DWT	2	11.2%	6.3%	11.3%	7.1%	7.7%	5.8%

<sup>20</sup> The assumptions made for 2021, 2030 and 2050 are kept constant for the 15-year period.

Ship type	Size category	Unit	Number of units assumed to be installed*	Rotor sail - newbuilding					
				2021		2030		2050	
				Low	High	Low	High	Low	High
	100,000-199,999	DWT	4	18.9%	10.6%	19.2%	12.0%	13.2%	9.9%
	200,000-+	DWT	4	14.1%	7.9%	14.4%	9.0%	9.9%	7.4%
Chemical tanker	0-4,999	DWT	0	Not considered.					
	5,000-9,999	DWT	1	9.0%	5.1%	9.0%	5.6%	5.9%	4.4%
	10,000-19,999	DWT	1	6.4%	3.6%	6.3%	4.0%	4.1%	3.1%
	20,000-39,999	DWT	1	13.0%	7.3%	13.1%	8.2%	8.9%	6.7%
	40,000+	DWT	2	13.0%	7.3%	13.1%	8.2%	8.9%	6.7%
Container	0-9,999	TEU	0	Not considered.					
	1,000-1,999	TEU	0						
	2,000-2,999	TEU	0						
	3,000-4,999	TEU	0						
	5,000-7,999	TEU	0						
	8,000-11,999	TEU	0						
	12,000-14,499	TEU	0						
	14,500-19,999	TEU	0						
	20,000+	TEU	0						
General cargo	0-4,999	DWT	0	Not considered.					
	5,000-9,999	DWT	1	16.5%	9.3%	16.4%	10.3%	10.7%	8.1%
	10,000-19,999	DWT	1	7.8%	4.4%	7.8%	4.9%	5.1%	3.8%
	20,000+	DWT	2	17.1%	9.6%	17.2%	10.8%	11.7%	8.8%
Liquefied gas tanker	0-49,999	cbm	0	Not considered.					
	50,000-99,999	cbm	1	2.9%	1.7%	2.9%	1.8%	1.9%	1.4%
	100,000-199,999	cbm	2	3.3%	1.8%	3.3%	2.1%	2.2%	1.7%
	200,000-+	cbm	4	8.0%	4.5%	8.1%	5.1%	5.6%	4.2%
Oil tanker	0-4,999	DWT	0	Not considered.					
	5,000-9,999	DWT	1	14.7%	8.2%	14.6%	9.1%	9.5%	7.1%
	10,000-19,999	DWT	1	9.5%	5.3%	9.4%	5.9%	6.1%	4.6%

Ship type	Size category	Unit	Number of units assumed to be installed*	Rotor sail - newbuilding					
				2021		2030		2050	
				Low	High	Low	High	Low	High
	20,000-59,999	DWT	2	15.8%	8.9%	15.9%	10.0%	10.8%	8.1%
	60,000-79,999	DWT	2	12.6%	7.1%	12.7%	8.0%	8.6%	6.5%
	80,000-119,999	DWT	2	11.7%	6.6%	11.8%	7.4%	8.0%	6.0%
	120,000-199,999	DWT	4	23.3%	13.1%	23.7%	14.9%	16.3%	12.3%
	200,000-+	DWT	4	16.1%	9.0%	16.4%	10.3%	11.3%	8.5%
Other liquids tankers	0-999	DWT	0	Not considered.					
	1,000-+	DWT	0						
Ferry-pax only	0-299	GT	0	Not considered.					
	300-999	GT	0						
	1,000-1,999	GT	0						
	2000-+	GT	1	7.3%	4.1%	7.2%	4.5%	4.7%	3.5%
Cruise	0-1,999	GT	0	Not considered.					
	2,000-9,999	GT	0						
	10,000-59,999	GT	1	3.1%	1.7%	3.0%	1.9%	2.0%	1.5%
	60,000-99,999	GT	1	1.0%	0.6%	1.0%	0.6%	0.7%	0.5%
	100,000-149,999	GT	2	2.5%	1.4%	2.5%	1.6%	1.7%	1.3%
	150,000-+	GT	2	2.5%	1.4%	2.6%	1.6%	1.7%	1.3%
Ferry Ro-Pax	0-1,999	GT	0	Not considered.					
	2,000-4,999	GT	0						
	5,000-9,999	GT	1	5.9%	3.3%	5.9%	3.7%	3.8%	2.9%
	10,000-19,999	GT	1	2.8%	1.6%	2.8%	1.8%	1.8%	1.4%
	20,000-+	GT	1	1.5%	0.9%	1.5%	0.9%	1.0%	0.7%
Refrigerated bulk	0-1,999	DWT	0	Not considered.					
	2,000-5,999	DWT	0						
	6,000-9,999	DWT	1	9.3%	5.2%	9.2%	5.8%	6.0%	4.5%
	10,000-+	DWT	1	4.3%	2.4%	4.3%	2.7%	2.8%	2.1%
Ro-Ro	0-4,999	DWT	0	Not considered.					
	5,000-9,999	DWT	1	4.4%	2.5%	4.4%	2.8%	2.9%	2.1%



Ship type	Size category	Unit	Number of units assumed to be installed*	Rotor sail - newbuilding					
				2021		2030		2050	
				Low	High	Low	High	Low	High
	10,000-14,999	DWT	1	2.8%	1.6%	2.8%	1.7%	1.8%	1.4%
	15,000+	DWT	2	8.0%	4.5%	8.1%	5.1%	5.5%	4.1%
Vehicle	0-29,999	GT	0	Not considered.					
	30,000-49,999	GT	1	3.2%	1.8%	3.1%	2.0%	2.1%	1.5%
	50,000+	GT	1	2.3%	1.3%	2.3%	1.4%	1.5%	1.1%

\*Smallest dimension indicated in blue, medium dimension in purple and largest in green.

Table 13. Range of required ME fuel saving to cover annual additional costs of WAPS – rotor sail - retrofit.

Ship type	Size category	Unit	Number of units assumed to be installed*	Rotor sail - retrofit					
				2021		2030		2050	
				Low	High	Low	High	Low	High
Bulk carrier	0-9,999	DWT	0	Not considered					
	10,000-34,999	DWT	1	7.2%	4.0%	7.2%	4.5%	4.7%	3.5%
	35,000-59,999	DWT	1	16.4%	9.2%	16.5%	10.4%	11.2%	8.4%
	60,000-99,999	DWT	2	11.8%	6.6%	11.9%	7.5%	8.0%	6.0%
	100,000-199,999	DWT	4	19.8%	11.1%	20.1%	12.6%	13.8%	10.3%
	200,000+	DWT	4	14.8%	8.3%	15.1%	9.5%	10.3%	7.7%
Chemical tanker	0-4,999	DWT	0	Not considered.					
	5,000-9,999	DWT	1	9.5%	5.3%	9.5%	5.9%	6.2%	4.6%
	10,000-19,999	DWT	1	6.7%	3.8%	6.7%	4.2%	4.4%	3.3%
	20,000-39,999	DWT	1	13.7%	7.7%	13.8%	8.7%	9.3%	7.0%
	40,000+	DWT	2	13.7%	7.7%	13.8%	8.7%	9.3%	7.0%
Container	0-9,999	TEU	0	Not considered.					
	1,000-1,999	TEU	0						
	2,000-2,999	TEU	0						
	3,000-4,999	TEU	0						
	5,000-7,999	TEU	0						

Ship type	Size category	Unit	Number of units assumed to be installed*	Rotor sail - retrofit					
				2021		2030		2050	
				Low	High	Low	High	Low	High
	8,000-11,999	TEU	0						
	12,000-14,499	TEU	0						
	14,500-19,999	TEU	0						
	20,000+	TEU	0						
General cargo	0-4,999	DWT	0	Not considered.					
	5,000-9,999	DWT	1	17.5%	9.8%	17.4%	10.9%	11.3%	8.5%
	10,000-19,999	DWT	1	8.3%	4.6%	8.2%	5.2%	5.4%	4.0%
	20,000+	DWT	2	18.0%	10.1%	18.1%	11.4%	12.2%	9.2%
Liquefied gas tanker	0-49,999	cbm	0	Not considered.					
	50,000-99,999	cbm	1	3.1%	1.7%	3.1%	1.9%	2.0%	1.5%
	100,000-199,999	cbm	2	3.4%	1.9%	3.4%	2.2%	2.3%	1.7%
	200,000+	cbm	4	8.4%	4.7%	8.5%	5.4%	5.8%	4.4%
Oil tanker	0-4,999	DWT	0	Not considered.					
	5,000-9,999	DWT	1	15.5%	8.7%	15.4%	9.7%	10.0%	7.5%
	10,000-19,999	DWT	1	10.0%	5.6%	9.9%	6.2%	6.5%	4.9%
	20,000-59,999	DWT	2	16.6%	9.3%	16.8%	10.5%	11.3%	8.5%
	60,000-79,999	DWT	2	13.3%	7.4%	13.4%	8.4%	9.0%	6.8%
	80,000-119,999	DWT	2	12.3%	6.9%	12.4%	7.8%	8.4%	6.3%
	120,000-199,999	DWT	4	24.5%	13.7%	24.9%	15.6%	17.1%	12.8%
	200,000+	DWT	4	16.9%	9.5%	17.2%	10.8%	11.8%	8.8%
Other liquids tankers	0-999	DWT	0	Not considered.					
	1,000+	DWT	0						
Ferry-pax only	0-299	GT	0	Not considered.					
	300-999	GT	0						
	1,000-1,999	GT	0						
	2000+	GT	1	7.7%	4.3%	7.6%	4.8%	5.0%	3.7%
Cruise	0-1,999	GT	0	Not considered.					
	2,000-9,999	GT	0						

Ship type	Size category	Unit	Number of units assumed to be installed*	Rotor sail - retrofit					
				2021		2030		2050	
				Low	High	Low	High	Low	High
	10,000-59,999	GT	1	3.2%	1.8%	3.2%	2.0%	2.1%	1.6%
	60,000-99,999	GT	1	1.1%	0.6%	1.1%	0.7%	0.7%	0.5%
	100,000-149,999	GT	2	2.6%	1.4%	2.6%	1.6%	1.8%	1.3%
	150,000-+	GT	2	2.7%	1.5%	2.7%	1.7%	1.8%	1.4%
Ferry Ro-Pax	0-1,999	GT	0	Not considered.					
	2,000-4,999	GT	0						
	5,000-9,999	GT	1	6.3%	3.5%	6.2%	3.9%	4.1%	3.0%
	10,000-19,999	GT	1	3.0%	1.7%	3.0%	1.9%	1.9%	1.4%
	20,000+	GT	1	1.6%	0.9%	1.6%	1.0%	1.0%	0.8%
Refrigerated bulk	0-1,999	DWT	0	Not considered.					
	2,000-5,999	DWT	0						
	6,000-9,999	DWT	1	9.8%	5.5%	9.8%	6.1%	6.4%	4.8%
	10,000+	DWT	1	4.5%	2.5%	4.5%	2.8%	2.9%	2.2%
Ro-Ro	0-4,999	DWT	0	Not considered.					
	5,000-9,999	DWT	1	4.7%	2.6%	4.6%	2.9%	3.0%	2.3%
	10,000-14,999	DWT	1	3.0%	1.7%	2.9%	1.8%	1.9%	1.4%
	15,000+	DWT	2	8.4%	4.7%	8.5%	5.3%	5.7%	4.3%
Vehicle	0-29,999	GT	0	Not considered.					
	30,000-49,999	GT	1	3.3%	1.9%	3.3%	2.1%	2.2%	1.6%
	50,000+	GT	1	2.4%	1.4%	2.4%	1.5%	1.6%	1.2%

\*Smallest dimension indicated in blue, medium dimension in purple and largest in green.

Table 14. Range of required relative ME fuel saving to cover annual additional costs of WAPS – hard sail - newbuilding.

Ship type	Size category	Unit	Number of units assumed to be installed*	Hard sail - newbuilding					
				2021		2030		2050	
				Low	High	Low	High	Low	High
Bulk carrier	0-9,999	DWT	0	Not considered.					
	10,000-34,999	DWT	1	4.1%	2.3%	3.8%	2.4%	2.1%	1.6%

Ship type	Size category	Unit	Number of units assumed to be installed*	Hard sail - newbuilding					
				2021		2030		2050	
				Low	High	Low	High	Low	High
	35,000-59,999	DWT	1	8.8%	4.9%	8.3%	5.2%	4.6%	3.4%
	60,000-99,999	DWT	2	6.3%	3.5%	5.9%	3.7%	3.3%	2.5%
	100,000-199,999	DWT	4	10.4%	5.8%	9.7%	6.1%	5.4%	4.1%
	200,000-+	DWT	4	7.8%	4.4%	7.3%	4.6%	4.1%	3.0%
Chemical tanker	0-4,999	DWT	0	Not considered.					
	5,000-9,999	DWT	1	5.4%	3.0%	5.0%	3.2%	2.8%	2.1%
	10,000-19,999	DWT	1	3.8%	2.1%	3.6%	2.2%	2.0%	1.5%
	20,000-39,999	DWT	1	7.3%	4.1%	6.9%	4.3%	3.8%	2.9%
	40,000-+	DWT	2	7.3%	4.1%	6.9%	4.3%	3.8%	2.9%
Container	0-9,999	TEU	0	Not considered.					
	1,000-1,999	TEU	0						
	2,000-2,999	TEU	0						
	3,000-4,999	TEU	0						
	5,000-7,999	TEU	0						
	8,000-11,999	TEU	0						
	12,000-14,499	TEU	0						
	14,500-19,999	TEU	0						
	20000-+	TEU	0						
General cargo	0-4,999	DWT	0	Not considered.					
	5,000-9,999	DWT	1	9.8%	5.5%	9.2%	5.8%	5.1%	3.9%
	10,000-19,999	DWT	1	4.7%	2.6%	4.4%	2.7%	2.4%	1.8%
	20,000-+	DWT	2	9.6%	5.4%	9.0%	5.7%	5.0%	3.8%
Liquefied gas tanker	0-49,999	cbm	0	Not considered.					
	50,000-99,999	cbm	1	1.8%	1.0%	1.6%	1.0%	0.9%	0.7%
	100,000-199,999	cbm	2	1.8%	1.0%	1.7%	1.1%	1.0%	0.7%
	200,000-+	cbm	4	4.4%	2.5%	4.1%	2.6%	2.3%	1.7%
Oil tanker	0-4,999	DWT	0	Not considered.					

Ship type	Size category	Unit	Number of units assumed to be installed*	Hard sail - newbuilding					
				2021		2030		2050	
				Low	High	Low	High	Low	High
	5,000-9,999	DWT	1	8.7%	4.9%	8.2%	5.1%	4.6%	3.4%
	10,000-19,999	DWT	1	5.6%	3.2%	5.3%	3.3%	2.9%	2.2%
	20,000-59,999	DWT	2	8.9%	5.0%	8.4%	5.3%	4.7%	3.5%
	60,000-79,999	DWT	2	7.1%	4.0%	6.7%	4.2%	3.7%	2.8%
	80,000-119,999	DWT	2	6.6%	3.7%	6.2%	3.9%	3.4%	2.6%
	120,000-199,999	DWT	4	12.8%	7.2%	12.0%	7.6%	6.7%	5.0%
	200,000-+	DWT	4	8.9%	5.0%	8.3%	5.2%	4.6%	3.5%
Other liquids tankers	0-999	DWT	0	Not considered.					
	1,000-+	DWT	0						
Ferry-pax only	0-299	GT	0	Not considered.					
	300-999	GT	0						
	1,000-1,999	GT	0						
	2,000-+	GT	1	4.3%	2.4%	4.0%	2.5%	2.3%	1.7%
Cruise	0-1,999	GT	0	Not considered.					
	2,000-9,999	GT	0						
	10,000-59,999	GT	1	1.8%	1.0%	1.7%	1.1%	0.9%	0.7%
	60,000-99,999	GT	1	0.6%	0.3%	0.6%	0.4%	0.3%	0.2%
	100,000-149,999	GT	2	1.4%	0.8%	1.3%	0.8%	0.7%	0.5%
	150,000-+	GT	2	1.4%	0.8%	1.3%	0.8%	0.7%	0.6%
Ferry Ro-Pax	0-1,999	GT	0	Not considered.					
	2,000-4,999	GT	0						
	5,000-9,999	GT	1	3.5%	2.0%	3.3%	2.1%	1.8%	1.4%
	10,000-19,999	GT	1	1.7%	0.9%	1.6%	1.0%	0.9%	0.7%
	20,000-+	GT	1	0.9%	0.5%	0.9%	0.5%	0.5%	0.4%
Refrigerated bulk	0-1,999	DWT	0	Not considered.					
	2,000-5,999	DWT	0						
	6,000-9,999	DWT	1	5.5%	3.1%	5.2%	3.3%	2.9%	2.2%

Ship type	Size category	Unit	Number of units assumed to be installed*	Hard sail - newbuilding					
				2021		2030		2050	
				Low	High	Low	High	Low	High
	10,000-+	DWT	1	2.6%	1.4%	2.4%	1.5%	1.3%	1.0%
Ro-Ro	0-4,999	DWT	0	Not considered.					
	5,000-9,999	DWT	1	2.6%	1.5%	2.5%	1.5%	1.4%	1.0%
	10,000-14,999	DWT	1	1.7%	0.9%	1.6%	1.0%	0.9%	0.7%
	15,000-+	DWT	2	4.5%	2.5%	4.2%	2.7%	2.4%	1.8%
Vehicle	0-29,999	GT	0	Not considered.					
	30,000-49,999	GT	1	1.9%	1.1%	1.8%	1.1%	1.0%	0.7%
	50,000-+	GT	1	1.4%	0.8%	1.3%	0.8%	0.7%	0.5%

\*Smallest dimension indicated in blue, medium dimension in purple and largest in green.

Table 15. Range of required relative ME fuel saving to cover annual additional costs of WAPS – hard sail - retrofit .

Ship type	Size category	Unit	Number of units assumed to be installed*	Hard sail - retrofit					
				2021		2030		2050	
				Low	High	Low	High	Low	High
Bulk carrier	0-9,999	DWT	0	Not considered.					
	10,000-34,999	DWT	1	4.4%	2.4%	4.1%	2.6%	2.3%	1.7%
	35,000-59,999	DWT	1	9.5%	5.3%	8.9%	5.6%	5.0%	3.7%
	60,000-99,999	DWT	2	6.8%	3.8%	6.4%	4.0%	3.6%	2.7%
	100,000-199,999	DWT	4	11.2%	6.3%	10.5%	6.6%	5.9%	4.4%
	200,000-+	DWT	4	8.4%	4.7%	7.9%	5.0%	4.4%	3.3%
Chemical tanker	0-4,999	DWT	0	Not considered.					
	5,000-9,999	DWT	1	5.8%	3.2%	5.4%	3.4%	3.0%	2.3%
	10,000-19,999	DWT	1	4.1%	2.3%	3.8%	2.4%	2.2%	1.6%
	20,000-39,999	DWT	1	7.9%	4.4%	7.4%	4.7%	4.2%	3.1%
	40,000-+	DWT	2	7.9%	4.4%	7.4%	4.7%	4.2%	3.1%
Container	0-9,999	TEU	0	Not considered.					
	1,000-1,999	TEU	0						
	2,000-2,999	TEU	0						

Ship type	Size category	Unit	Number of units assumed to be installed*	Hard sail - retrofit					
				2021		2030		2050	
				Low	High	Low	High	Low	High
	3,000-4,999	TEU	0						
	5,000-7,999	TEU	0						
	8,000-11,999	TEU	0						
	12,000-14,499	TEU	0						
	14,500-19,999	TEU	0						
	20000+	TEU	0						
General cargo	0-4,999	DWT	0	Not considered.					
	5,000-9,999	DWT	1	10.6%	5.9%	10.0%	6.3%	5.6%	4.2%
	10,000-19,999	DWT	1	5.0%	2.8%	4.7%	3.0%	2.6%	2.0%
	20,000+	DWT	2	10.4%	5.8%	9.8%	6.1%	5.5%	4.1%
Liquefied gas tanker	0-49,999	cbm	0	Not considered.					
	50,000-99,999	cbm	1	1.9%	1.1%	1.8%	1.1%	1.0%	0.7%
	100,000-199,999	cbm	2	2.0%	1.1%	1.9%	1.2%	1.0%	0.8%
	200,000+	cbm	4	4.7%	2.7%	4.5%	2.8%	2.5%	1.9%
Oil tanker	0-4,999	DWT	0	Not considered.					
	5,000-9,999	DWT	1	9.4%	5.2%	8.8%	5.5%	4.9%	3.7%
	10,000-19,999	DWT	1	6.0%	3.4%	5.7%	3.6%	3.2%	2.4%
	20,000-59,999	DWT	2	9.6%	5.4%	9.0%	5.7%	5.1%	3.8%
	60,000-79,999	DWT	2	7.6%	4.3%	7.2%	4.5%	4.0%	3.0%
	80,000-119,999	DWT	2	7.1%	4.0%	6.7%	4.2%	3.7%	2.8%
	120,000-199,999	DWT	4	13.8%	7.7%	13.0%	8.2%	7.3%	5.5%
	200,000+	DWT	4	9.5%	5.4%	9.0%	5.6%	5.0%	3.8%
Other liquids tankers	0-999	DWT	0	Not considered.					
	1,000+	DWT	0						
Ferry-pax only	0-299	GT	0	Not considered.					
	300-999	GT	0						
	1,000-1,999	GT	0						



Ship type	Size category	Unit	Number of units assumed to be installed*	Hard sail - retrofit					
				2021		2030		2050	
				Low	High	Low	High	Low	High
	2,000-+	GT	1	4.6%	2.6%	4.4%	2.7%	2.4%	1.8%
Cruise	0-1,999	GT	0	Not considered.					
	2,000-9,999	GT	0						
	10,000-59,999	GT	1	1.9%	1.1%	1.8%	1.2%	1.0%	0.8%
	60,000-99,999	GT	1	0.6%	0.4%	0.6%	0.4%	0.3%	0.3%
	100,000-149,999	GT	2	1.5%	0.8%	1.4%	0.9%	0.8%	0.6%
	150,000-+	GT	2	1.5%	0.9%	1.4%	0.9%	0.8%	0.6%
Ferry Ro-Pax	0-1,999	GT	0	Not considered.					
	2,000-4,999	GT	0						
	5,000-9,999	GT	1	3.8%	2.1%	3.6%	2.2%	2.0%	1.5%
	10,000-19,999	GT	1	1.8%	1.0%	1.7%	1.1%	1.0%	0.7%
	20,000-+	GT	1	1.0%	0.5%	0.9%	0.6%	0.5%	0.4%
Refrigerated bulk	0-1,999	DWT	0	Not considered.					
	2,000-5,999	DWT	0						
	6,000-9,999	DWT	1	5.9%	3.3%	5.6%	3.5%	3.1%	2.4%
	10,000-+	DWT	1	2.7%	1.5%	2.6%	1.6%	1.5%	1.1%
Ro-Ro	0-4,999	DWT	0	Not considered.					
	5,000-9,999	DWT	1	2.8%	1.6%	2.7%	1.7%	1.5%	1.1%
	10,000-14,999	DWT	1	1.8%	1.0%	1.7%	1.1%	0.9%	0.7%
	15,000-+	DWT	2	4.9%	2.7%	4.6%	2.9%	2.6%	1.9%
Vehicle	0-29,999	GT	0	Not considered.					
	30,000-49,999	GT	1	2.0%	1.1%	1.9%	1.2%	1.1%	0.8%
	50,000-+	GT	1	1.5%	0.8%	1.4%	0.9%	0.8%	0.6%

\*Smallest dimension indicated in blue, medium dimension in purple and largest in green.

Table 16. Range of required relative ME fuel saving to cover annual additional costs of WAPS – suction wing - newbuilding.

Ship type	Size category	Unit	Number of units assumed to be installed*	Suction wing - newbuilding					
				2021		2030		2050	
				Low	High	Low	High	Low	High
Bulk carrier	0-9,999	DWT	0	Not considered.					
	10,000-34,999	DWT	1	3.5%	2.0%	3.7%	2.3%	2.7%	2.0%
	35,000-59,999	DWT	1	11.0%	6.2%	11.0%	6.9%	7.5%	5.6%
	60,000-99,999	DWT	2	7.9%	4.4%	7.9%	5.0%	5.4%	4.1%
	100,000-199,999	DWT	4	15.0%	8.4%	14.9%	9.3%	9.9%	7.4%
	200,000-+	DWT	4	11.2%	6.3%	11.1%	7.0%	7.4%	5.6%
Chemical tanker	0-4,999	DWT	0	Not considered.					
	5,000-9,999	DWT	1	4.7%	2.6%	4.9%	3.1%	3.6%	2.7%
	10,000-19,999	DWT	1	3.3%	1.8%	3.4%	2.2%	2.5%	1.9%
	20,000-39,999	DWT	1	9.2%	5.1%	9.2%	5.8%	6.3%	4.7%
	40,000-+	DWT	2	9.2%	5.1%	9.2%	5.8%	6.3%	4.7%
Container	0-9,999	TEU	0	Not considered.					
	1,000-1,999	TEU	0						
	2,000-2,999	TEU	0						
	3,000-4,999	TEU	0						
	5,000-7,999	TEU	0						
	8,000-11,999	TEU	0						
	12,000-14,499	TEU	0						
	14,500-19,999	TEU	0						
	20000-+	TEU	0						
General cargo	0-4,999	DWT	0	Not considered.					
	5,000-9,999	DWT	1	8.6%	4.8%	8.9%	5.6%	6.6%	4.9%
	10,000-19,999	DWT	1	4.1%	2.3%	4.2%	2.7%	3.1%	2.3%
	20,000-+	DWT	2	12.0%	6.7%	12.1%	7.6%	8.3%	6.2%
Liquefied gas tanker	0-49,999	cbm	0	Not considered.					
	50,000-99,999	cbm	1	1.5%	0.9%	1.6%	1.0%	1.2%	0.9%

Ship type	Size category	Unit	Number of units assumed to be installed*	Suction wing - newbuilding					
				2021		2030		2050	
				Low	High	Low	High	Low	High
	100,000-199,999	cbm	2	2.3%	1.3%	2.3%	1.4%	1.6%	1.2%
	200,000-+	cbm	4	6.3%	3.6%	6.3%	4.0%	4.2%	3.1%
Oil tanker	0-4,999	DWT	0	Not considered.					
	5,000-9,999	DWT	1						
	10,000-19,999	DWT	1	7.6%	4.2%	7.9%	5.0%	5.8%	4.4%
	20,000-59,999	DWT	2	4.9%	2.7%	5.1%	3.2%	3.8%	2.8%
	60,000-79,999	DWT	2	11.1%	6.2%	11.2%	7.0%	7.6%	5.7%
	80,000-119,999	DWT	2	8.9%	5.0%	8.9%	5.6%	6.1%	4.6%
	120,000-199,999	DWT	4	8.2%	4.6%	8.3%	5.2%	5.7%	4.2%
	200,000-+	DWT	4	18.5%	10.4%	18.4%	11.5%	12.2%	9.2%
Other liquids tankers	0-999	DWT	0	Not considered.					
	1,000-+	DWT	0						
Ferry-pax only	0-299	GT	0	Not considered.					
	300-999	GT	0						
	1,000-1,999	GT	0						
	2,000-+	GT	1	3.8%	2.1%	3.9%	2.5%	2.9%	2.2%
Cruise	0-1,999	GT	0	Not considered.					
	2,000-9,999	GT	0						
	10,000-59,999	GT	1	1.6%	0.9%	1.6%	1.0%	1.2%	0.9%
	60,000-99,999	GT	1	0.5%	0.3%	0.5%	0.3%	0.4%	0.3%
	100,000-149,999	GT	2	1.7%	1.0%	1.7%	1.1%	1.2%	0.9%
	150,000-+	GT	2	1.8%	1.0%	1.8%	1.1%	1.2%	0.9%
Ferry Ro-Pax	0-1,999	GT	0	Not considered.					
	2,000-4,999	GT	0						
	5,000-9,999	GT	1	3.1%	1.7%	3.2%	2.0%	2.4%	1.8%
	10,000-19,999	GT	1	1.5%	0.8%	1.5%	1.0%	1.1%	0.8%
	20,000-+	GT	1	0.8%	0.4%	0.8%	0.5%	0.6%	0.5%

Ship type	Size category	Unit	Number of units assumed to be installed*	Suction wing - newbuilding					
				2021		2030		2050	
				Low	High	Low	High	Low	High
Refrigerated bulk	0-1,999	DWT	0	Not considered.					
	2,000-5,999	DWT	0						
	6,000-9,999	DWT	1	4.8%	2.7%	5.0%	3.2%	3.7%	2.8%
	10,000-+	DWT	1	2.2%	1.2%	2.3%	1.5%	1.7%	1.3%
Ro-Ro	0-4,999	DWT	0	Not considered.					
	5,000-9,999	DWT	1						
	10,000-14,999	DWT	1	1.4%	0.8%	1.5%	0.9%	1.1%	0.8%
	15,000-+	DWT	2	5.7%	3.2%	5.7%	3.6%	3.9%	2.9%
Vehicle	0-29,999	GT	0	Not considered.					
	30,000-49,999	GT	1						
	50,000-+	GT	1	1.2%	0.7%	1.3%	0.8%	0.9%	0.7%

\*Smallest dimension indicated in blue, medium dimension in purple and largest in green.

Table 17. Range of required relative ME fuel saving to cover annual additional costs of WAPS – suction wing - retrofit.

Ship type	Size category	Unit	Number of units assumed to be installed*	Suction wing - retrofit					
				2021		2030		2050	
				Low	High	Low	High	Low	High
Bulk carrier	0-9,999	DWT	0	Not considered.					
	10,000-34,999	DWT	1						
	35,000-59,999	DWT	1	11.5%	6.5%	11.5%	7.2%	7.8%	5.9%
	60,000-99,999	DWT	2	8.3%	4.6%	8.3%	5.2%	5.6%	4.2%
	100,000-199,999	DWT	4	15.8%	8.8%	15.6%	9.8%	10.3%	7.7%
	200,000-+	DWT	4	11.8%	6.6%	11.7%	7.3%	7.7%	5.8%
Chemical tanker	0-4,999	DWT	0	Not considered.					
	5,000-9,999	DWT	1						
	10,000-19,999	DWT	1	3.4%	1.9%	3.6%	2.2%	2.6%	2.0%
	20,000-39,999	DWT	1	9.6%	5.4%	9.6%	6.0%	6.5%	4.9%
	40,000-+	DWT	2	9.6%	5.4%	9.6%	6.0%	6.5%	4.9%
Container	0-9,999	TEU	0	Not considered.					

Ship type	Size category	Unit	Number of units assumed to be installed*	Suction wing - retrofit											
				2021		2030		2050							
				Low	High	Low	High	Low	High						
	1,000-1,999	TEU	0												
	2,000-2,999	TEU	0												
	3,000-4,999	TEU	0												
	5,000-7,999	TEU	0												
	8,000-11,999	TEU	0												
	12,000-14,499	TEU	0												
	14,500-19,999	TEU	0												
	20000+	TEU	0												
General cargo	0-4,999	DWT	0												
	5,000-9,999	DWT	1							8.9%	5.0%	9.3%	5.8%	6.8%	5.1%
	10,000-19,999	DWT	1							4.2%	2.4%	4.4%	2.8%	3.2%	2.4%
	20,000+	DWT	2							12.6%	7.1%	12.6%	7.9%	8.5%	6.4%
Liquefied gas tanker	0-49,999	cbm	0	Not considered.											
	50,000-99,999	cbm	1	1.6%	0.9%	1.7%	1.0%	1.2%	0.9%						
	100,000-199,999	cbm	2	2.4%	1.3%	2.4%	1.5%	1.6%	1.2%						
	200,000+	cbm	4	6.7%	3.7%	6.6%	4.2%	4.4%	3.3%						
Oil tanker	0-4,999	DWT	0	Not considered.											
	5,000-9,999	DWT	1	7.9%	4.4%	8.2%	5.2%	6.0%	4.5%						
	10,000-19,999	DWT	1	5.1%	2.9%	5.3%	3.3%	3.9%	2.9%						
	20,000-59,999	DWT	2	11.7%	6.6%	11.7%	7.3%	7.9%	5.9%						
	60,000-79,999	DWT	2	9.3%	5.2%	9.3%	5.8%	6.3%	4.7%						
	80,000-119,999	DWT	2	8.7%	4.9%	8.7%	5.4%	5.9%	4.4%						
	120,000-199,999	DWT	4	19.5%	10.9%	19.3%	12.1%	12.7%	9.5%						
	200,000+	DWT	4	13.5%	7.5%	13.3%	8.4%	8.8%	6.6%						
Other liquids tankers	0-999	DWT	0	Not considered.											
	1,000+	DWT	0												
	0-299	GT	0	Not considered.											

Ship type	Size category	Unit	Number of units assumed to be installed*	Suction wing - retrofit					
				2021		2030		2050	
				Low	High	Low	High	Low	High
Ferry-pax only	300-999	GT	0						
	1,000-1,999	GT	0						
	2,000+	GT	1	3.9%	2.2%	4.1%	2.6%	3.0%	2.2%
Cruise	0-1,999	GT	0	Not considered.					
	2,000-9,999	GT	0						
	10,000-59,999	GT	1	1.6%	0.9%	1.7%	1.1%	1.3%	0.9%
	60,000-99,999	GT	1	0.5%	0.3%	0.6%	0.4%	0.4%	0.3%
	100,000-149,999	GT	2	1.8%	1.0%	1.8%	1.1%	1.2%	0.9%
	150,000+	GT	2	1.9%	1.1%	1.9%	1.2%	1.3%	1.0%
Ferry Ro-Pax	0-1,999	GT	0	Not considered.					
	2,000-4,999	GT	0						
	5,000-9,999	GT	1	3.2%	1.8%	3.3%	2.1%	2.4%	1.8%
	10,000-19,999	GT	1	1.5%	0.8%	1.6%	1.0%	1.2%	0.9%
	20,000+	GT	1	0.8%	0.5%	0.9%	0.5%	0.6%	0.5%
Refrigerated bulk	0-1,999	DWT	0	Not considered.					
	2,000-5,999	DWT	0						
	6,000-9,999	DWT	1	5.0%	2.8%	5.2%	3.3%	3.8%	2.9%
	10,000+	DWT	1	2.3%	1.3%	2.4%	1.5%	1.8%	1.3%
Ro-Ro	0-4,999	DWT	0	Not considered.					
	5,000-9,999	DWT	1	2.4%	1.3%	2.5%	1.6%	1.8%	1.4%
	10,000-14,999	DWT	1	1.5%	0.8%	1.6%	1.0%	1.1%	0.9%
	15,000+	DWT	2	5.9%	3.3%	5.9%	3.7%	4.0%	3.0%
Vehicle	0-29,999	GT	0	Not considered.					
	30,000-49,999	GT	1	1.7%	1.0%	1.8%	1.1%	1.3%	1.0%
	50,000+	GT	1	1.2%	0.7%	1.3%	0.8%	0.9%	0.7%

\*Smallest dimension indicated in blue, medium dimension in purple and largest in green.

Table 18. Range of required relative ME fuel saving to cover annual additional costs of WAPS – kite - newbuilding.

Ship type	Size category	Unit	Number of units assumed to be installed*	Kite - newbuilding					
				2021		2030		2050	
				Low	High	Low	High	Low	High
Bulk carrier	0-9,999	DWT	0	Not considered.					
	10,000-34,999	DWT	1	5.5%	3.1%	6.1%	3.8%	4.1%	3.1%
	35,000-59,999	DWT	1	12.7%	7.1%	12.4%	7.8%	7.7%	5.8%
	60,000-99,999	DWT	1	9.1%	5.1%	8.9%	5.6%	5.5%	4.2%
	100,000-199,999	DWT	1	9.5%	5.3%	9.2%	5.8%	5.6%	4.2%
	200,000-+	DWT	1	7.1%	4.0%	6.9%	4.3%	4.2%	3.2%
Chemical tanker	0-4,999	DWT	0	Not considered.					
	5,000-9,999	DWT	1	7.2%	4.1%	8.1%	5.1%	5.4%	4.1%
	10,000-19,999	DWT	1	5.1%	2.9%	5.7%	3.6%	3.8%	2.9%
	20,000-39,999	DWT	1	3.3%	1.9%	3.7%	2.3%	2.5%	1.9%
	40,000-+	DWT	1	10.6%	5.9%	10.4%	6.5%	6.4%	4.8%
Container	0-9,999	TEU	0	Not considered.					
	1,000-1,999	TEU	1	2.7%	1.5%	3.0%	1.9%	2.0%	1.5%
	2,000-2,999	TEU	1	1.9%	1.1%	2.2%	1.4%	1.5%	1.1%
	3,000-4,999	TEU	1	1.2%	0.7%	1.4%	0.9%	0.9%	0.7%
	5,000-7,999	TEU	1	0.8%	0.5%	0.9%	0.6%	0.6%	0.5%
	8,000-11,999	TEU	1	2.1%	1.2%	2.0%	1.3%	1.3%	0.9%
	12,000-14,499	TEU	1	2.0%	1.1%	1.9%	1.2%	1.2%	0.9%
	14,500-19,999	TEU	1	2.2%	1.2%	2.1%	1.3%	1.3%	1.0%
	20000-+	TEU	1	2.7%	1.5%	2.7%	1.7%	1.6%	1.2%
General cargo	0-4,999	DWT	0	Not considered.					
	5,000-9,999	DWT	1	13.3%	7.4%	14.8%	9.3%	10.0%	7.5%
	10,000-19,999	DWT	1	6.3%	3.5%	7.0%	4.4%	4.7%	3.5%
	20,000-+	DWT	1	13.9%	7.8%	13.6%	8.5%	8.5%	6.3%
Liquefied gas tanker	0-49,999	cbm	0	Not considered.					
	50,000-99,999	cbm	1	2.4%	1.3%	2.6%	1.7%	1.8%	1.3%



Ship type	Size category	Unit	Number of units assumed to be installed*	Kite - newbuilding					
				2021		2030		2050	
				Low	High	Low	High	Low	High
	100,000-199,999	cbm	1	2.6%	1.5%	2.6%	1.6%	1.6%	1.2%
	200,000-+	cbm	1	4.0%	2.2%	3.9%	2.5%	2.4%	1.8%
Oil tanker	0-4,999	DWT	0	Not considered.					
	5,000-9,999	DWT	1	11.7%	6.6%	13.1%	8.2%	8.8%	6.6%
	10,000-19,999	DWT	1	7.6%	4.3%	8.5%	5.3%	5.7%	4.3%
	20,000-59,999	DWT	1	12.8%	7.2%	12.6%	7.9%	7.8%	5.9%
	60,000-79,999	DWT	1	10.2%	5.7%	10.0%	6.3%	6.2%	4.7%
	80,000-119,999	DWT	1	9.5%	5.3%	9.3%	5.8%	5.8%	4.3%
	120,000-199,999	DWT	1	11.7%	6.6%	11.4%	7.2%	7.0%	5.2%
	200,000-+	DWT	1	8.1%	4.5%	7.9%	4.9%	4.8%	3.6%
Other liquids tankers	0-999	DWT	0	Not considered.					
	1,000-+	DWT	0						
Ferry-pax only	0-299	GT	0	Not considered.					
	300-999	GT	0						
	1,000-1,999	GT	0						
	2,000-+	GT	0						
Cruise	0-1,999	GT	0	Not considered.					
	2,000-9,999	GT	0						
	10,000-59,999	GT	0						
	60,000-99,999	GT	0						
	100,000-149,999	GT	0						
	150,000-+	GT	0						
Ferry Ro-Pax	0-1,999	GT	0	Not considered.					
	2,000-4,999	GT	0						
	5,000-9,999	GT	0						
	10,000-19,999	GT	0						
	20,000-+	GT	0						
	0-1,999	DWT	0	Not considered.					

Ship type	Size category	Unit	Number of units assumed to be installed*	Kite - newbuilding					
				2021		2030		2050	
				Low	High	Low	High	Low	High
Refrigerated bulk	2,000-5,999	DWT	0	Not considered.					
	6,000-9,999	DWT	1	7.5%	4.2%	8.3%	5.2%	5.6%	4.2%
	10,000-+	DWT	1	3.4%	1.9%	3.9%	2.4%	2.6%	1.9%
Ro-Ro	0-4,999	DWT	0	Not considered.					
	5,000-9,999	DWT	1	3.5%	2.0%	4.0%	2.5%	2.7%	2.0%
	10,000-14,999	DWT	1	2.2%	1.3%	2.5%	1.6%	1.7%	1.3%
	15,000-+	DWT	1	6.5%	3.6%	6.4%	4.0%	4.0%	3.0%
Vehicle	0-29,999	GT	0	Not considered.					
	30,000-49,999	GT	1	2.5%	1.4%	2.8%	1.8%	1.9%	1.4%
	50,000-+	GT	1	1.9%	1.0%	2.1%	1.3%	1.4%	1.0%

\*Smallest dimension indicated in blue, medium dimension in purple and largest in green.

Table 19. Range of required relative ME fuel saving to cover annual additional costs of WAPS – kite - retrofit.

Ship type	Size category	Unit	Number of units assumed to be installed*	Kite - retrofit					
				2021		2030		2050	
				Low	High	Low	High	Low	High
Bulk carrier	0-9,999	DWT	0	Not considered.					
	10,000-34,999	DWT	1	5.7%	3.2%	6.1%	3.8%	4.1%	3.1%
	35,000-59,999	DWT	1	13.3%	7.5%	13.1%	8.2%	8.1%	6.1%
	60,000-99,999	DWT	1	9.6%	5.4%	9.4%	5.9%	5.8%	4.4%
	100,000-199,999	DWT	1	10.0%	5.6%	9.8%	6.1%	5.9%	4.5%
	200,000-+	DWT	1	7.5%	4.2%	7.3%	4.6%	4.5%	3.3%
Chemical tanker	0-4,999	DWT	0	Not considered.					
	5,000-9,999	DWT	1	7.5%	4.2%	8.1%	5.1%	5.4%	4.1%
	10,000-19,999	DWT	1	5.3%	3.0%	5.7%	3.6%	3.8%	2.9%
	20,000-39,999	DWT	1	3.5%	1.9%	3.7%	2.3%	2.5%	1.9%
	40,000-+	DWT	1	11.1%	6.2%	10.9%	6.9%	6.8%	5.1%
Container	0-9,999	TEU	0	Not considered.					

Ship type	Size category	Unit	Number of units assumed to be installed*	Kite - retrofit					
				2021		2030		2050	
				Low	High	Low	High	Low	High
	1,000-1,999	TEU	1	2.8%	1.6%	3.0%	1.9%	2.0%	1.5%
	2,000-2,999	TEU	1	2.0%	1.1%	2.2%	1.4%	1.5%	1.1%
	3,000-4,999	TEU	1	1.3%	0.7%	1.4%	0.9%	0.9%	0.7%
	5,000-7,999	TEU	1	0.9%	0.5%	0.9%	0.6%	0.6%	0.5%
	8,000-11,999	TEU	1	2.2%	1.2%	2.1%	1.3%	1.3%	1.0%
	12,000-14,499	TEU	1	2.1%	1.2%	2.0%	1.3%	1.3%	1.0%
	14,500-19,999	TEU	1	2.3%	1.3%	2.3%	1.4%	1.4%	1.0%
	20000+	TEU	1	2.9%	1.6%	2.8%	1.8%	1.7%	1.3%
General cargo	0-4,999	DWT	0	Not considered.					
	5,000-9,999	DWT	1	13.8%	7.7%	14.8%	9.3%	10.0%	7.5%
	10,000-19,999	DWT	1	6.5%	3.7%	7.0%	4.4%	4.7%	3.5%
	20,000+	DWT	1	14.6%	8.2%	14.3%	9.0%	8.9%	6.7%
Liquefied gas tanker	0-49,999	cbm	0	Not considered.					
	50,000-99,999	cbm	1	2.5%	1.4%	2.6%	1.7%	1.8%	1.3%
	100,000-199,999	cbm	1	2.8%	1.6%	2.7%	1.7%	1.7%	1.3%
	200,000+	cbm	1	4.2%	2.4%	4.1%	2.6%	2.5%	1.9%
Oil tanker	0-4,999	DWT	0	Not considered.					
	5,000-9,999	DWT	1	12.2%	6.9%	13.1%	8.2%	8.8%	6.6%
	10,000-19,999	DWT	1	7.9%	4.4%	8.5%	5.3%	5.7%	4.3%
	20,000-59,999	DWT	1	13.5%	7.6%	13.3%	8.3%	8.2%	6.2%
	60,000-79,999	DWT	1	10.8%	6.0%	10.6%	6.6%	6.6%	4.9%
	80,000-119,999	DWT	1	10.0%	5.6%	9.8%	6.2%	6.1%	4.6%
	120,000-199,999	DWT	1	12.3%	6.9%	12.1%	7.6%	7.4%	5.5%
	200,000+	DWT	1	8.5%	4.8%	8.3%	5.2%	5.1%	3.8%
Other liquids tankers	0-999	DWT	0	Not considered.					
	1,000+	DWT	0						
	0-299	GT	0	Not considered.					

Ship type	Size category	Unit	Number of units assumed to be installed*	Kite - retrofit					
				2021		2030		2050	
				Low	High	Low	High	Low	High
Ferry-pax only	300-999	GT	0						
	1,000-1,999	GT	0						
	2,000+	GT	0						
Cruise	0-1,999	GT	0	Not considered.					
	2,000-9,999	GT	0						
	10,000-59,999	GT	0						
	60,000-99,999	GT	0						
	100,000-149,999	GT	0						
	150,000+	GT	0						
Ferry Ro-Pax	0-1,999	GT	0	Not considered.					
	2,000-4,999	GT	0						
	5,000-9,999	GT	0						
	10,000-19,999	GT	0						
	20,000+	GT	0						
Refrigerated bulk	0-1,999	DWT	0	Not considered.					
	2,000-5,999	DWT	0						
	6,000-9,999	DWT	1	7.8%	4.4%	8.3%	5.2%	5.6%	4.2%
	10,000+	DWT	1	3.6%	2.0%	3.9%	2.4%	2.6%	1.9%
Ro-Ro	0-4,999	DWT	0	Not considered.					
	5,000-9,999	DWT	1	3.7%	2.1%	4.0%	2.5%	2.7%	2.0%
	10,000-14,999	DWT	1	2.3%	1.3%	2.5%	1.6%	1.7%	1.3%
	15,000+	DWT	1	6.9%	3.8%	6.7%	4.2%	4.2%	3.1%
Vehicle	0-29,999	GT	0	Not considered.					
	30,000-49,999	GT	1	2.6%	1.5%	2.8%	1.8%	1.9%	1.4%
	50,000+	GT	1	1.9%	1.1%	2.1%	1.3%	1.4%	1.0%

\*Smallest dimension indicated in blue, medium dimension in purple and largest in green.

The main engine fuel consumption savings that would be required to cover the annual costs for the WAPS, varies due to several factors:

- Variation due to fuel price uncertainty
  - Higher ME fuel consumption savings are required in case of lower fuel prices (see 'Low' scenarios).
- Variation between ship sizes:
  - The annual costs of the systems depend on the number and dimensions of the WAPS units installed, which are assumed to be higher/larger for the larger ships.
  - Larger ships have, in general, higher annual fuel consumption and fuel expenditures compared to smaller ships, which is why lower relative savings are required to cover the same system costs.
- Variation over time:
  - System costs are assumed to decline over time, due to economies of scale, which is why the required ME fuel reduction declines over time, too.
  - Fuel expenditures are expected to increase over time due to rising fuel prices, which is why the required ME fuel consumption reduction also declines over time. Carbon costs contribute to this decline too, so long as non-renewable fuel is, at least partially, used.
- Variation between WAPS:
  - The costs vary among the different technologies, their dimensions and providers. While there is a high uncertainty on the costs assumed, these costs are expected to decline over time.

As an example, Figure 13 (newbuilding) and Figure 14 (retrofit) illustrate the relative ME fuel savings that are required for the various sizes of bulk carriers and the different WAPSs as provided in the tables above. A central fuel price scenario is used, with the 'error bars' showing the range for a low- and a high-price scenarios, confirming the variations describe above. In addition, since the same number and size of units is assumed for the last two size categories, as well as for the second and third size categories, the relative savings required to cover the costs is lower for the larger size category in each case. This is due to the higher fuel consumption of the larger ships.

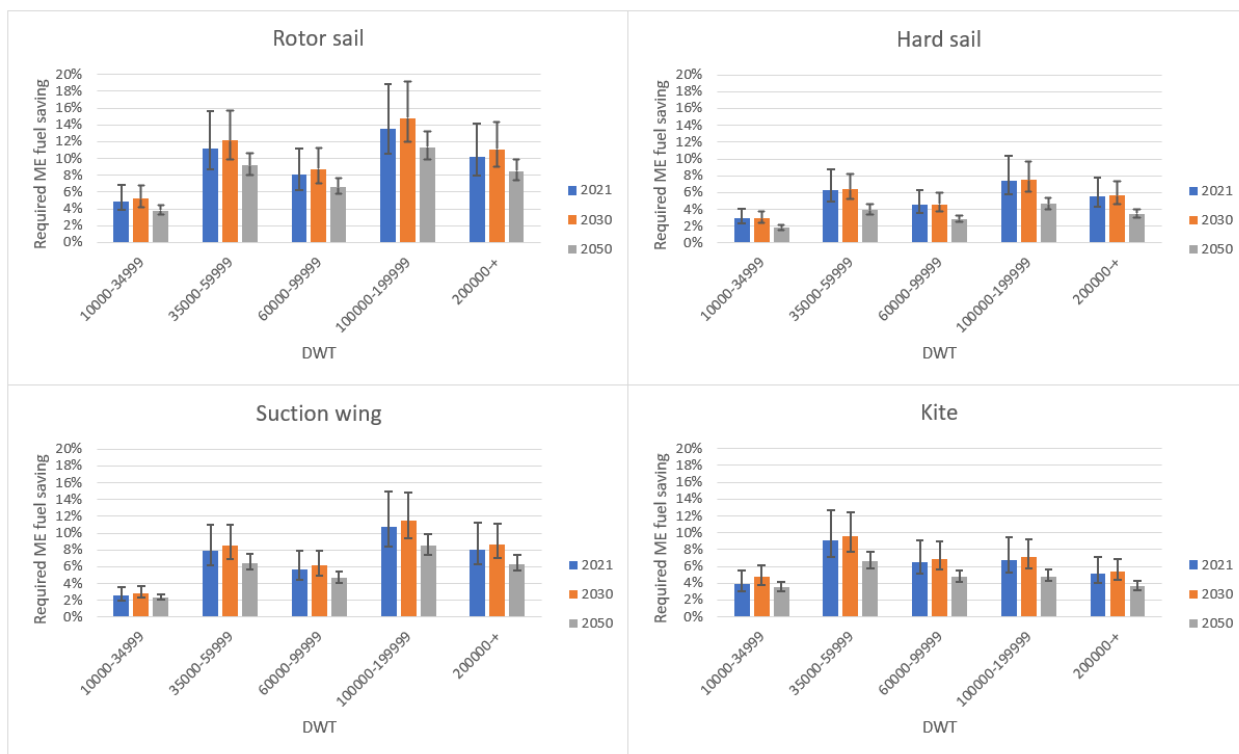

Figure 13. Required relative ME fuel saving to cover annual additional costs of WAPS – bulk carrier newbuilding.

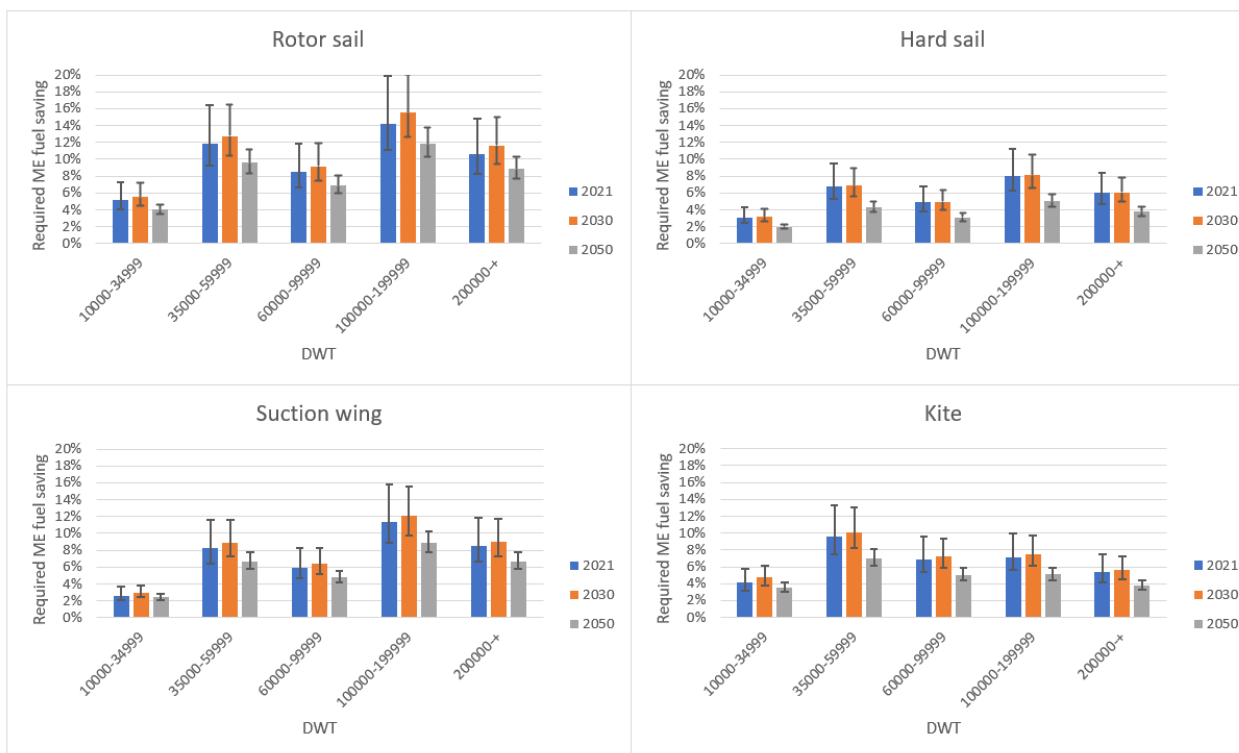

Figure 14. Required relative ME fuel saving to cover annual additional costs of WAPS – bulk carrier retrofit.

Whether the required fuel consumption saving as calculated in this section can be achieved or not depends on various factors:

- The technical savings potential of each technology.
- The number and dimension of the systems installed. These have to be selected to maximise the cost-benefit ratio per ship. Installing multiple systems increases the thrust, but the cost-benefit ratio of an additional unit should be checked as interactions between the units may impact the effectiveness. Therefore, as an example, it may be more economical to install three rather than four units. For large ships with more deck space, the installation of multiple units might be more profitable, since the interaction between the units is potentially lower.
- The profitability is particularly dependent on the speeds at which the vessel operates, the routes on which it is deployed and the experience of the crew (refer to subsection 2.2.1 and 2.4.1). As already explained, larger ships operate more often at open sea and WAPS can turn to be more profitable. For ships sailing on predictable routes, the profitability of the investment is more certain. The operational profile and typical routes of vessel may dictate with type of WAPS is more suitable.

Uncertainty of data and the numerous factors that affect the selection of a WAPS and its performance, highlight the need for assessments to be made on a case-by-case basis. Especially when considering the viability of short-term investments, the fuel costs and consequently the potential benefits of the WAPS may be relatively low compared to 2030 and 2050.

#### 2.5.4 Financing Options

Different financing options are available for investing in WAPS.

Aside from (partially) debt-financed acquisitions, some technology providers are co-operating with financial institutions to offer lease programs. Ship owners have also been known to forge agreements with the technology providers to share the gains of WAPS over a specific time frame. For the latter, an open-source online calculation tool has been developed to support forge agreements that are profitable for both parties. (HXX Blue, 2023)

To lessen investment risks, some vendors are offering performance guarantees. These agreements can offer clauses that protect the ship owner against underperforming systems and are most commonly offered when ships are known to sail on routes with favourable wind conditions. In this respect, ships engaged in liner shipping (with fixed schedules and on fixed routes, for example), as opposed to those that transport goods traded on the spot market, are seen as safer investments.

At the same time, there is a WAPS concept where a kite-propelled tug tows a ship, which allows the ship owner or operator to pay for the towing service, rather than invest in a kite.

#### 2.5.5 Techno-economic conclusions

Due to the uncertainty on the expected savings, the required relative main engine's fuel savings required to cover the annual costs from a WAPS installation have been calculated over a 15-years period.

In general, the multitude of factors that would affect the WAPS selection, together with the uncertainty around the quality of the data sets create a need for assessments to be made on a case-by-case basis, especially if a short-term investment is being considered; in the short term, fuel costs (and as a result the potential benefits of the system) are expected to relatively low compared to 2030 and 2050 timeframes.



It is noted that the results are very sensitive on the initial CAPEX assumption and that variation on the assumed input will influence the results.

The following conclusions can be drawn for different WAPS and ship segments:

- The results of the different segments are difficult to compare since a different number of units and size have been installed, as considered more suitable. Therefore, the estimated required relative savings can only be used as an indication for the assumed number and size of units assumed for each segment. The higher the number of units and their size the higher the costs and the required relative savings, but also the expected savings (e.g., capsize bulk carrier). On the other hand, for some vessels, such as cruise ships, only one or two units have been assumed. This lowers the required savings since lower costs have been assumed. The expected savings are also lower in this case.
- In general, larger ships and those that sail at higher speeds tend to feature comparatively higher annual fuel consumption and fuel costs compared to smaller and slower ships, which is why lower relative fuel savings are required for the former to cover the same system costs.
- For ships with a relatively high share of auxiliary engine fuel consumption, a WAPS might be a less attractive option compared to ships with a relatively high share of main engine fuel consumption.
- For ships engaged in tramp trades, with relatively low predictability on the routes, the profitability of the systems can be less certain.

Independent of the type of WAPS, the relative amount of fuel that needs to be saved to cover the costs are expected to decline over time, due to the increased use of more expensive renewable fuels; at the same time the savings from lower carbon costs can also be expected to fall if renewable fuels are used. An anticipated decline in system costs also will contribute to a decline in the fuel savings required to recover capital costs.

Whether the required fuel savings can be achieved depends on many factors. As already explained in previous subsections, aside from the inherent savings potential of specific WAPS technologies, selecting the optimal type, optimal number and dimension of the units -- as well as operating the vessels at optimal speeds on optimised routes – play important roles in reducing emissions and fuel use up to the desired and required amounts. Crew training is also crucial for the effective use of the WAPS.

It is also noted that there are several financing options and performance guarantees for WAPSs available in the current market.

## 3. Safety and environmental regulations, standard and guidelines

This chapter describes the environmental regulations, standards and guidelines available and currently in development for the adoption of WAPS.

### 3.1 International Maritime Organization (IMO) Requirements

#### 3.1.1 Maritime Safety Committee (MSC)

As WAPS tend to have large areas that are exposed directly to the wind, they can affect a ship's manoeuvrability and stability. Also, some types of WAPS, such as rotor sails and sails, install tall structures on vessel decks which may substantially increase air draft. Potentially, this could create additional obstacles to visibility from the bridge, radar and navigational lighting. The IMO's Maritime Safety Committee has developed several regulations governing manoeuvrability, stability and navigational safety, included in the International Convention for the Safety of Life at Sea (SOLAS), and related Codes and Standards, which are discussed in detail in this section. In addition, this section refers to the SOLAS requirements for fire safety. Whether the ships equipped with WAPS comply with these safety regulations may impact the decision on investing on WAPS, but also which WAPS to be adopted. In some cases, as described below, alternative designs and arrangements could be one way to demonstrate compliance with the SOLAS requirements.

#### **Standards for Ship Manoeuvrability**

##### *General*

The Standards for Ship Manoeuvrability, Resolution MSC 137 (76), was adopted on 4 December 2002. These standards are used to help evaluate the manoeuvring performance of ships and to assist those responsible for the design, construction, repair and operation of ships. The standards are applicable to ships of all rudder and propulsion types of 100 m in length or longer, and to chemical tankers and gas carriers of any length (Standards for Ship Maneuverability, MSC 137 (76), 2002). Currently, the standards do not have specific requirements to consider the impact of WAPS. As WAPS is part of the propulsion system, it is necessary to derive a practical method to include the WAPS into the manoeuvrability assessment.

##### *Criteria*

These standards mainly assess four aspects of ship manoeuvrability – turning ability, initial turning ability, yaw-checking and course-keeping abilities and stopping ability. Among these aspects, WAPS mostly affect the turning and yaw and course-keeping abilities. There are on-going studies to assess each WAPS's influence on manoeuvring compliance and seakeeping operability on performance (WiSP2 Wind Assisted Propulsion, 2021).

The detailed criteria are shown below. As the manoeuvrability of ships is affected by WAPS, ships bearing these systems should be investigated to see if they still comply with the existing criteria, and whether new criteria will be needed.

##### ***“Turning ability***

*The advance should not exceed 4.5 ship lengths (L) and the tactical diameter should not exceed 5 ship lengths in the turning-circle manoeuvre.*

##### ***Initial turning ability***

*With the application of 10° rudder angle to port/starboard, the ship should not have travelled more than 2.5 ship lengths by the time the heading has changed by 10° from the original heading.*

##### ***Yaw-checking and course-keeping abilities***

1. *The value of the first overshoot angle in the 10°/10° zig-zag test should not exceed:*

- 1)  $10^\circ$  if  $L/V$  is less than 10 s;
  - 2)  $20^\circ$  if  $L/V$  is 30 s or more; and
  - 3)  $(5 + 1/2(L/V))$  degrees if  $L/V$  is 10 s or more, but less than 30 s,
- where  $L$  and  $V$  are expressed in m and m/s, respectively.
2. The value of the second overshoot angle in the  $10^\circ/10^\circ$  zig-zag test should not exceed:
    - 1)  $25^\circ$ , if  $L/V$  is less than 10 s;
    - 2)  $40^\circ$ , if  $L/V$  is 30 s or more; and
    - 3)  $(17.5 + 0.75(L/V))^\circ$ , if  $L/V$  is 10 s or more, but less than 30 s.
  3. The value of the first over-shoot angle in the  $20^\circ/20^\circ$  zig-zag test should not exceed  $25^\circ$ .

### **Stopping ability**

The track reach in the full astern stopping test should not exceed 15 ship lengths. However, this value may be modified by the administration when ships of large displacement make this criterion impracticable, but should in no case exceed 20 ship lengths” (Standards for Ship Maneuverability, MSC 137 (76), 2002).

### *Validation Methods*

The standards accept the two alternative validation methods listed below:

- “scale model tests and/or computer predictions using mathematical models can be performed to predict compliance at the design stage. In this case, full-scale trials should be conducted to validate these results. The ship should then be considered to meet these Standards regardless of full-scale trial results, except where the Administration determines that the prediction efforts were substandard and/or the ship performance is in substantial disagreement with these Standards;
- compliance with the Standards can be demonstrated based on the results of the full-scale trials conducted in accordance with the Standards. If a ship is found in substantial disagreement with the Standards, then the Administration should take remedial action, as appropriate.”

MSC/Circ.1053, Explanatory Notes to the Standards for Ship Manoeuvrability, approved in 2002, provides guidance for the application of the Standards for Ship Manoeuvrability (Resolution MSC.137(76)) along with the general philosophy and background for the Standards. As per the notes, the trials are to be conducted under the following conditions:

### *Environment*

Manoeuvring trials should be performed in the calmest possible weather conditions. The geographical position of the trial is preferably in a deep sea, sheltered area where accurate positioning fixing is possible. Trials should be conducted in conditions within the following limits:

1. Deep unrestricted water: more than 4 times the mean draught.
2. Wind: not to exceed Beaufort 5.
3. Waves: not to exceed sea state 4.
4. Current: uniform only.

### *Loading*

The ship should preferably be loaded to the full load draught and even keel, however, a 5% deviation from that draught may be allowed. Alternatively, the ship may be in a ballast condition with a minimum of trim and sufficient propeller immersion.

### *Ship speed*

The test speed is defined in paragraph 4.2.1 of the Standards.

### *Heading*

Preferably head to the wind during the approach run.

### *Engine*

*Engine control setting to be kept constant during the trial, if not otherwise stated in following procedures.*

### *Approach run*

*The above-mentioned conditions must be fulfilled for at least two minutes preceding the test. The ship is running at test speed up wind with minimum rudder to keep its course. (MSC/Circ.1053, Explanatory Notes to the Standards for Ship Manoeuvrability, 2022)*

The above criteria and validation methods have historically worked well for ships with conventional propulsion systems. However, their application to ships with WAPS may face several issues:

- The wind speed and wind direction have a significant impact on the performance of ships with WAPS.
- Manoeuvrability should be considered with and without WAPS in operation. Without WAPS in operation, the manoeuvrability should be checked at a ship speed corresponding to 85% MCR (maximum continuous rating) at calm sea and minimal wind. Whereas for ships with WAPS in operation, the trial may need to be carried out at a higher pre-specified wind force and direction (to ensure that the effect of WAPS is captured) and potentially at a lower engine load. The pre-specified conditions should reflect the worst encountering scenario, i.e., at an angle resulting to the highest side force.
- It is necessary to investigate the appropriate wind speed and wind direction to be used for the manoeuvrability check for ships with WAPS. The wind condition under normal ship-operation condition is considered the most representative ship-operation condition. When ships sailing different routes, the various probability of different wind conditions should be taken into consideration.
- Furthermore, if the WAPS cannot be switched off or folded during adverse conditions, the wind condition during adverse weather could be assessed for safety considerations. This is because vessels with WAPS will have larger windage areas and therefore the impact of adverse weather conditions on manoeuvrability will be more significant.
- Using sea trial to verify the impact of specific wind speeds and directions on manoeuvrability is challenging, as it is difficult to find and maintain the same wind speed or direction. With the wind conditions not guaranteed, if sea trials needed to be carried out, a grace period would need to be granted for the trials to be completed after delivery. However, since the grace period may need to be long, this will incur considerable administrative burden to both the verifier and the ship.
- Alternative verification methods should be considered, such as calibrating a basic model through the sea trials and the test case validated with a specific wind speed and angle by numerical simulation. The waves also will affect the manoeuvrability and course-keeping of the ships. The wave height will be commensurate to the wind force. In such case, port and starboard manoeuvring performances will be substantially different. Hence, whether it is possible to develop an effective method to consider the impact of waves on the ship's manoeuvrability will need to be investigated.

In any case, the verification process of manoeuvrability for ships fitted with WAPS needs to be considered and amended if necessary.

## **International Code on Intact Stability (IS Code)**

### *Enter into Force*

The 2008 IS Code, Resolution MSC.267(85), was adopted on 4 December 2008 and took effect on 1 July 2010 when the respective amendments to SOLAS and 1988 Load Lines Protocol entry into force. The Code presents

mandatory and recommendatory criteria for stability and other measures for ensuring the safe operation of ships; its goal was to minimise the risk to personnel onboard these ships and to the environment.

### *Application*

The Code is applicable to the following types of ships and other marine vehicles (of 24m in length or more, unless otherwise stated):

- Passenger ships
- Cargo ships
- Cargo ships carrying timber deck cargo or grain in bulk
- Passenger ships
- Fishing vessels
- Special purpose ships
- Offshore supply vessels
- Mobile offshore drilling units
- Dynamically supported craft
- Pontoons; and
- Cargo ships carrying containers on deck and container ships (IMO Intact Stability Code, 2009)

### *Structure*

The IS Code has two parts, Part A and Part B; Part A addresses mandatory criteria and Part B contains recommendations for certain types of ships and additional guidelines. The mandatory criteria cover general and special criteria for certain types of ships, such as passenger ships and high-speed craft.

The general criteria section has two parts. One part is the criteria regarding righting lever-curve properties, while the other offers criteria governing severe wind and rolling (weather criterion). The recommendation guidelines cover design criteria for certain types of ships, guidance for preparing information on stability, stability calculations performed by the associated instruments, operational provisions against capsizing, icing considerations, considerations for watertight and weathertight integrity and the determination of lightship parameters.

It is observed that the additional lateral windage area can be rather large, especially for wings and sails, and this can be detrimental to the intact stability of vessels with WAPS. WAPS that can be stowed should be differentiated from those that cannot. If both conditions are calculated in terms of stability, the situation with deployed WAPS will most probably dominate (which is worse in terms of stability). To overcome any stability issues, either the maximum windage area needs to be reduced (offering less wind-assisted propulsion) or hydrodynamically sub-optimal hulls need to be used to increase the vessel's stability. This means that systems that cannot be stowed may come with a substantial penalty. One way to overcome this would be carry out model experiments instead of direct calculations to derive the wind heeling moment, with the latter being conservative; this is similar to what is typically assessed for vessels such as cruise ships with large windage areas, as per MSC.1/Circ.1200. This Circular provides the industry with alternative ways to assess severe wind and rolling criterion, as contained in the IS Code.

Moreover, it is noticed that while intact stability assumes that the ship is upright, WAPS increases the probability that it will operate with a heel angle, and this may impact the criteria for the righting lever. WAPS will also increase the vertical centre of gravity of the vessel, so loading conditions may need to be adjusted accordingly to ensure the vessel can maintain her vertical centre of gravity within the limits of the stability criteria. Icing scenarios will also need to be considered because ice accretion on the WAPS may add weight and also affect vessel's vertical centre of gravity.

Furthermore, currently only static stability is examined by regulations. However, some WAPS (e.g., rotor sails) may create additional heeling moment from the spinning of the rotor; this also needs to be considered for vessel stability.

### **Second Generation Intact Stability Criteria**

Due to the large variety of ship designs and operating profiles, a few ships have been identified as more at risk for encountering critical stability issues caused by waves; for those ships or groups, dynamic-stability criteria that demonstrate their safety levels are sufficient needs to be applied. However, the current IS Code still does not address problems related to dynamic stability failures for a wide variety of ship types, sizes, operational profiles and environmental conditions.

However, IMO MSC has recognised that performance-oriented criteria for the dynamic-stability phenomena in waves needs to be developed and implemented to ensure consistency (IMO SDC 7/WP.6 Report of the Drafting Group on Intact Stability, 2020). Thus, the IMO has developed performance-based criteria for assessing five dynamic stability failure modes in waves, including: dead ship condition; excessive acceleration; pure loss of stability; parametric rolling; and surf-riding/broaching.

The interim guidelines were finalised in February 2020 (MSC-Circ.1627). Revised guidance to the Master for avoiding dangerous situations in adverse weather and sea conditions (MSC.1/Circ.1228) also has been published.

Both the IS Code and the second-generation intact stability criteria do not have specific requirements to consider the impact of WAPS, which may affect calculations used to assess ship stability, including larger side force and heeling moment, change in weight distribution etc.

### **SOLAS Chapter II-1**

SOLAS (1974) was adopted on 1 November of that year by the International Conference on Safety of Life at Sea, under the auspices of the IMO; it entered into force on 25 May 1980.

SOLAS regulation Chapter II-1, Part B-1 and Part B-4, provide requirements of intact stability and damage stability for passenger ships and cargo ships (SOLAS Consolidated Edition, 2020). In addition, the Revised Explanatory Notes to the SOLAS Chapter II-1 Subdivision and Damage Stability Regulations, Resolution MSC.429 (98), were adopted in June 2017 to help Administrations interpret and apply the aforementioned subdivision and damage stability regulations (Revised Explanatory Notes to the SOLAS Chapter II-1 Subdivision and Damage Stability, MSC.429(98), 2017). These SOLAS requirements include additional stability requirements to the minimum intact stability requirement to be complied within Part A of the 2008 IS Code.

It is suggested to check how the damage stability criteria in SOLAS Chapter II-1 should be applied to ships with WAPS. Indicatively, operating at a higher probability of an angle of heel, as mentioned earlier, may delay the operation of passive cross-flooding devices and increase the time needed for equalisation.

Moreover, it is highlighted that in case a ship is damaged, a WAPS could cause an adverse heeling moment, potentially creating the need to reassess the damage stability in case of retrofit. However, as per probabilistic damage stability in SOLAS, the factor  $s_{mom,l}$  which is used to evaluate the effect of heeling moments on damage survivability is applicable only to passenger ships. Therefore, while it might be straightforward to add this adverse heeling moment due to WAPS to the calculation or passenger ships, for cargo ships, wind moment is not assessed. Further studies are needed to investigate this issue because this may also have some implications on cargo ships which do not have WAPS fitted.



Alternative design requirements and arrangements are well established in SOLAS Chapter II-1. Regulation 55 provides a methodology for alternative design and arrangements for machinery, electrical installations, as well as low-flashpoint fuel-storage and distribution systems (related to the requirements set out in Parts C, D, E and G of Chapter II-1). However, this regulation does not cover the stability requirements (Part B).

While ships with WAPS are expected to be able to meet the SOLAS damage stability requirements, studies will be needed to identify the potential impact of WAPS on damage stability and to investigate if the current damage stability criteria will work for the particularities that are introduced with the WAPS installed, as described above. In some cases, Flag Administrations may decide to impose additional requirements.

To conclude, choices need to be made to ensure consistent implementation among Flag Administrations and Classification Societies.

## **SOLAS Chapter II-2**

SOLAS Chapter II-2 provides requirements for fire protection, fire detection and fire extinction, which aim to:

- *Prevent the occurrence of fire and explosion.*
- *Reduce the risk to life caused by fire.*
- *Reduce the risk of damage caused by fire to the ship, its cargo and the environment.*
- *Contain, control and suppress fire and explosion in the compartment of origin; and*
- *Provide adequate and readily accessible means of escape for passengers and crew. (SOLAS Consolidated Edition, 2020)*

WAPS are not expected to affect the fire-safety requirements in SOLAS Chapter II-2. However, this is highly dependent on the materials used for the WAPS, which may increase the fire load and risk of fire in the areas where they are installed. The effect of the WAPS on escape requirements also needs to be checked; i.e., if the system is damaged it could block escape routes, access to Life Saving Appliances (LSA) or launching of LSA. WAPS also may affect the location of the helicopter-winning areas. These and other potential events need to be carefully considered.

SOLAS Chapter II-2 Regulation 17 provides alternative design requirements that promote safety, and this could be the way to demonstrate compliance should WAPS need to deviate from prescriptive requirements. These are usually to cover single deviations from the prescriptive requirements but, for WAPS, deviations across several regulations may need to be considered.

## **SOLAS Chapter V**

### *General*

SOLAS Chapter V provides requirements for navigational safety, which are applicable to all ships on all voyages, except:

- *Warships, naval auxiliaries and other ships owned or operated by a contracting Government and used only on government non-commercial service; and*
- *Ships solely navigating the Great Lakes of North America and their connecting and tributary waters as far east as the lower exit of the St Lambert Lock at Montreal in the Province of Quebec, Canada (SOLAS Consolidated Edition, 2020).*

### *Criteria*

SOLAS Chapter V Reg 22 provides detailed requirements for navigation bridge visibility, which stipulates:



*“ .1 The view of the sea surface from the conning position shall not be obscured by more than two ship lengths, or 500 m, whichever is less, forward of the bow to 10° on either side, under all conditions of draught, trim and deck cargo;*

*.2 No blind sector, caused by cargo, cargo gear or other obstructions outside of the wheelhouse forward of the beam which obstructs the view of the sea surface as seen from the conning position, shall exceed 10°. The total arc of blind sectors shall not exceed 20°. The clear sectors between blind sectors shall be at least 5°. However, in the view described in 1., each individual blind sector shall not exceed 5°;*

*.3 The horizontal field of vision from the conning position shall extend over an arc of not less than 225°, that is, from right ahead to not less than 22.5° abaft the beam on either side of the ships;*

*.4 From each bridge wing, the horizontal field of vision shall extend over an arc of at least 225°, that is from at least 45° on the opposite bow through right ahead and then from right ahead to right astern through 180° on the same side of the ship;*

*.5 From the main steering position, the horizontal field of vision shall extend over an arc from right ahead to at least 60° on each side of the ship;*

*.6 The ship's side shall be visible from the bridge wing;*

*.7 The height of the lower edge of the navigation bridge front windows above the bridge deck shall be kept as low as possible. In no case shall the lower edge present an obstruction to the forward view as described in this regulation;*

*.8 The upper edge of the navigation bridge front windows shall allow a forward view of the horizon for a person with a height of eye of 1,800 mm above the bridge deck at the conning position, when the ship is pitching in heavy seas. The administration, if satisfied that a 1,800 mm height of eye is unreasonable and impractical, may allow reduction, of the height of eye but not to less than 1,600 mm;*

*.9 Windows shall meet the following requirements:*

*.1 To help avoid reflections, the bridge front windows shall be inclined from the vertical plane top out at an angle of not less than 10° and not more than 25°;*

*.2 Framing between navigation bridge windows shall be kept to a minimum and not be installed immediately forward of any workstation;*

*.3 Polarised and tinted windows shall not be fitted;*

*.4 A clear view through at least two of the navigation bridge front windows and, depending on the bridge configuration, an additional number of clear-view windows shall be provided at all times, regardless of weather conditions.”*

SOLAS Chapter V, Regulation 22/3 leaves open a consideration for unconventional design, which says that:

*“On ships of unconventional design which, in the opinion of the Administration, cannot comply with this regulation, arrangements shall be provided to achieve a level of visibility that is as near as practical to that prescribed in this regulation.” (SOLAS Consolidated Edition, 2020)*

The large area of some types of WAPS, such as rotor sails and especially sails, could cause blind spots exceeding the limits specified in Regulation 22. Alternatively, the WAPS solution may be compromised by the number or size of units needed to comply with the SOLAS requirements. Another potentially less-than perfect option would be for the bridge to be relocated forward, causing acceleration that could increase crew fatigue.

Although SOLAS Regulation 22/3 leaves special consideration open for WAPS, whether the design can be accepted is up to the Flag Administration. As there are no specific guidelines for the consideration of WAPS, many Flags approve the design on a case-by-case basis. This results in uncertainties in design approvals which may be a barrier to a wider adoption of WAPS.

The development of specific guidelines on navigation safety for ships with WAPS would be welcomed and streamline the approval process. This could be started by collecting information about the solutions that already have been approved on a case-by-case basis.

With today's technological advancements, cameras could potentially be used to solve visibility issues.

SOLAS Chapter V, Regulation 19/2.7 has requirements for radar systems, which state:

*“All ships of 3,000 gross tonnages and upwards shall, in addition to meeting the requirements of paragraph 2.5, have:*

*1. a 3 GHz radar or where considered appropriate by the Administration, a second 9 GHz radar, or other means, to determine and display the range and bearing of other surface craft, obstructions, buoys, shorelines and navigational marks to assist in navigation and in collision avoidance, which are functionally independent of those referred to in paragraph.*

*2. a second automatic tracking aid, or other means, to plot automatically the range and bearing of other targets to determine collision risk which are functionally independent of those referred to in paragraph 2.5.5.”*

### **Revised Performance Standards for Radar Equipment, MSC.192(79)**

Revised Performance Standards for Radar Equipment (Resolution MSC.192(79) was adopted in December 2004. They aim to unify the general regulations for maritime radar, especially for display and presentation of navigation-related information. The standards are applicable to all shipborne radar installations mandated by the 1974 SOLAS Convention, as amended.

Radar equipment is crucial to safe navigation and avoiding collision. However, the large area of WAPS, such as rotor sails and sails, could create radar blind spots greater than what is allowed by the regulations. This might stop the ship from meeting the requirements of MSC.192(79)/7.5.1, where the requirements for radar and radar antenna are provided. As per 7.5.1, *“blind sectors should be kept to a minimum and should not be placed in an arc of the horizon from the right ahead direction to 22.5° abaft the beam and especially should avoid the right ahead direction (relative bearing 000°). The installation of the antenna should be in such a manner that the performance of the radar system is not substantially degraded. The antenna should be mounted clear of any structure that may cause signal reflections, including other antenna and deck structure or cargo. In addition, the height of the antenna should take account of target detection performance relating to range of first detection and target visibility in sea clutter.”*

### **Guidelines for the Installation of Shipborne Radar Equipment, SN1/Circ.271**

The Guidelines for the Installation of Shipborne Radar Equipment, SN1/Circ.271, entered into force on 22 May 2008. Their aim is to ensure the correct installation of radar equipment. The guidelines are applicable to all shipborne radar installations mandated by the 1974 SOLAS Convention, as amended.

The installation of a WAPS can create blind spots in radar greater than what is allowed by the regulations, potentially affecting compliance with requirements in SN.1/Circ.271/6.3, as indicated below:

#### *“6.3 Blind sectors and range*

*To make full benefit from the radar, it is vitally important for the OOW that horizontal and vertical blind sectors for the radar antennae are minimised. The objective is to see the horizon freely through 360° as nearly as possible, noting the requirement of 7.1 below.*

*For all radar systems, and where practical,*

*a) A line of sight from the radar antenna to the bow of the ship should hit the surface of the sea in not more than 500 m or twice the ship length, depending which value is smaller, for all load and trim conditions.*

*b) The radar antenna should be located in an elevated position to permit maximum target visibility.*

*c) Blind sectors should be kept to a minimum and should not occur in an arc of the horizon from right ahead to 22.5° abaft the beam to either side.*

*Note: Any two blind sectors separated by 3° or less should be treated as one blind sector.*

d) *Individual blind sectors of more than 5°, or a total arc of blind sectors of more than 20°, should not occur in the remaining arc, excluding the arc in the above subparagraph (c).*

e) *For radar installations with two radar systems, where possible, the antennas should be placed in such a way as to minimise the blind sectors.”* (Guidelines for the Installation of Shipborne Radar Equipment, SN1/Circ.271, 2008).

Overall, as mentioned earlier, it needs to be demonstrated that the vessel with the WAPS deployed satisfies all the criteria of Chapter V. It is noted that Regulation 3 of Chapter V, as well as Regulation 5 of Chapter I, leave room for exemptions and equivalents, however, the interpretation regarding WAPS lies with the Flag Administration, and this is to be considered on a case-by-case.

Since the use of alternative design and arrangements is not clear in SOLAS Chapter V, this may be considered a prerequisite prior to developing specific guidelines which allow alternative methods to compensate the larger blind spots caused by larger sail areas; as such it has the potential to contribute to the adoption of WAPS, which would allow for a common approach. It should also be noted that Maritime Autonomous Surface Ships would use some of the solutions that would be used by WAPS to compensate for larger than allowed blind spots or sectors.

### 3.1.2 Marine Environment Protection Committee (MEPC)

As mentioned in the Introduction MEPC adopted the revised IMO GHG strategy in June 2023 (MEPC 80), increasing significantly the levels of ambition to reaching net-zero GHG emissions by or around (i.e., close to) 2050. Among others, it incentivises the uptake of zero or near-zero GHG emission technologies, fuels and/or energy sources with an ambition these to represent at least 5%, striving for 10%, of the energy used by international shipping by 2030. Needless to say, that WAPS could play a major role towards achieving these targets. The mid-term measures (technical and economic) have yet to be decided.

WAPS is a recognised energy efficiency technology under IMO and vessels with such systems installed are expected to realise benefit when it comes to compliance with the Regulations that have been included under the International Convention for the Prevention of Pollution from Ships (MARPOL) Annex VI during the last decade, namely Energy Efficiency Design Index (EEDI), Energy Efficiency Existing Ship Index (EEXI) or Carbon Intensity Indicator (CII).

However, the inclusion of WAPS in the calculation of the attained EEDI and EEXI has been challenging. The industry also has questions about whether WAPS' potential to reduce main engine power will affect the minimum requirements for propulsion power (MPP) in adverse conditions. The related guidelines are discussed in this section.

#### **MARPOL Annex VI**

MARPOL sets out the international requirements for preventing the pollution from ships that travel internationally. Annex VI – Regulations for the prevention of air pollution from ships – was adopted by the Protocol of 1997 to MARPOL. It introduced the IMO's regulatory framework for air pollution and key air-pollutant controls for shipping, including for ozone-depleting substances, NO<sub>x</sub>, SO<sub>x</sub>, Volatile Organic Compounds (VOCs), shipboard incineration and the availability and quality of fuel oils. By later amendment, the IMO introduced regulations covering energy efficiency (MARPOL ANNEX VI and NTC 2008, 2017).

One of the most recent additions in MARPOL is the CII (Carbon Intensity Indicator), which entered into force on the 1<sup>st</sup> January 2023, under Regulation 28. CII is a metric of operational carbon intensity based on the actual fuel consumption reported by the vessel under the Fuel Oil Data Collection System (DCS), which means that it is based on the actual fuel consumption reported by each vessel. Therefore, a ship with WAPS is expected to have lower fuel consumption for a constant speed or constant fuel consumption for a higher speed, both potentially resulting in a lower CII. Overall, from a regulatory aspect, the effect of WAPS on CII is considered straight forward (i.e., based on the actual fuel consumption and distance sailed) and will not be analysed further in this study.

It is also noted that just before this study was published, amendments to MARPOL ANNEX VI were approved (at MEPC 80), namely those related to Appendix IX (Information to be submitted to the IMO Ship Fuel Oil Consumption Database - DCS), setting the reporting of “Installation of innovative technology” as mandatory. This means that ships will need to report the presence of WAPS onboard. As soon as this information would start to populate the IMO DCS Database (something to be expected in the coming years), may provide a further insight on the impact of WAPS.

The EEDI (Energy Efficiency Design Index) was made mandatory for all new ships at MEPC 62 (July 2011) with the adoption of amendments to MARPOL Annex VI (Resolution MEPC.203(62)), by Parties to MARPOL Annex VI. This was the first legally binding climate-change treaty to be adopted since the Kyoto Protocol. Currently, ships installed with WAPS are supposed to comply with this regulation, where applicable.

Regulation 22 of MARPOL Annex VI requires that the attained EEDI shall be calculated for each new ship, each new ship that undergoes a major conversion, or existing ships that undergo so many changes that, in the Administration’s judgement, they are considered a new ship. The 2014 Guidelines on the method of calculation for the EEDI and MEPC.308(73) as amended, are to be used for related calculations. Similarly, there is a new requirement for attained EEXI for the existing ships, as per Regulation 23 entered into force in 1<sup>st</sup> of January 2023. The attained EEDI and EEXI values are considered to be a measure of the ships’ energy efficiency, expressed in CO<sub>2</sub> emissions per cargo tonnage and distance carried (gCO<sub>2</sub>/t nm).

Regulation 24 of MARPOL Annex VI provides EEDI requirements. The required EEDI regulation is made up of two parts, a reference line and reduction factors for the EEDI relative to the reference line. The reductions required for different types of vessels are shown in the Table 20 (MARPOL ANNEX VI and NTC 2008, 2017). Similarly, there is a new requirement for attained EEXI as per Regulation 25 which entered into force in 1<sup>st</sup> of November 2022.

The calculation principles are the same for EEDI and EEXI, with some reduction factors being different.

Table 20. Reduction Factors (in %) for the EEDI Relative to the EEDI Reference Line.

Ship Type	Size	Phase 0 1 Jan 2013 – 31 Dec 2014	Phase 1 1 Jan 2015 – 31 Dec 2019	Phase 2 1 Jan 2020 – 31 Mar 2022	Phase 2 1 Jan 2020 – 31 Dec 2024	Phase 3 1 Apr 2022 and onwards	Phase 3 1 Jan 2025 and onwards
Bulk carrier	20,000 DWT and above	0	10		20		30
	10,000 and above but less than 20,000 DWT	n/a	0-10*		0-20*		0-30*
Gas carrier	15,000 DWT and above	0	10	20		30	
	10,000 and above but less than 15,000 DWT	0	10		20		30
	2,000 and above but less than 10,000 DWT	n/a	0-10*		0-20*		0-30*
Tanker	20,000 DWT and above	0	10		20		30
	4,000 and above but less than 20,000	n/a	0-10*		0-20*		0-30*

Ship Type	Size	Phase 0 1 Jan 2013 – 31 Dec 2014	Phase 1 1 Jan 2015 – 31 Dec 2019	Phase 2 1 Jan 2020 – 31 Mar 2022	Phase 2 1 Jan 2020 – 31 Dec 2024	Phase 3 1 Apr 2022 and onwards	Phase 3 1 Jan 2025 and onwards
	DWT						
Container ship	200,000 DWT and above	0	10	20		50	
	120,000 and above but less than 200,000 DWT	0	10	20		45	
	80,000 and above but less than 120,000 DWT	0	10	20		40	
	40,000 and above but less than 80,000 DWT	0	10	20		35	
	15,000 and above but less than 40,000 DWT	0	10	20		30	
	10,000 and above but less than 15,000 DWT	n/a	0-10*	0-20*		15-30*	
General cargo ships	15,000 DWT and above	0	10	15		30	
	3,000 and above but less than 15,000 DWT	n/a	0-10*	0-15*		0-30*	
Refrigerated cargo carrier	5,000 DWT and above	0	10		15		30
	3,000 and above but less than 5,000 DWT	n/a	0-10*		0-15*		0-30*
Combination carrier	20,000 DWT and above	0	10		20		30
	4,000 and above but less than 20,000 DWT	n/a	0-10*		0-20*		0-30*
LNG Carrier***	10,000 DWT and above	n/a	10**	20		30	
Ro-ro cargo ship (vehicle carrier)***	10,000 DWT and above	n/a	5**		15		30
Ro-ro cargo ship***	2,000 DWT and above	n/a	5**		20		30
	1,000 and	n/a	0-5**, **		0-20*		0-30*

Ship Type	Size	Phase 0 1 Jan 2013 – 31 Dec 2014	Phase 1 1 Jan 2015 – 31 Dec 2019	Phase 2 1 Jan 2020 – 31 Mar 2022	Phase 2 1 Jan 2020 – 31 Dec 2024	Phase 3 1 Apr 2022 and onwards	Phase 3 1 Jan 2025 and onwards
	above but less than 2,000 DWT						
Ro-ro passenger ship***	1,000 DWT and above	n/a	5**		20		30
	250 and above but less than 1,000 DWT	n/a	0-5*,**		0-20*		0-30*
Cruise passenger ship having non- conventional propulsion***	85,000GT and above	n/a	5**	20		30	
	25,000 and above but less than 85,000 GT	n/a	0-5*,**	0-20*		0-30*	

\* Reduction factor to be linearly interpolated between the two values dependent upon ship size. The lower value of the reduction factor is to be applied to the smaller ship size.

\*\*Phase 1 commences for those ships on 1 September 2015.

\*\*\* Reduction factor applies to those ships delivered on or after 1 September 2019, as defined in paragraph 2.1 of regulation 2.

### **The 2022 Guidelines on the method of calculation of the attained energy efficiency design index (EEDI) for new ships, MEPC.364(79)**

The 2022 Guidelines on the method of calculation of the attained EEDI for new ships, Resolution MEPC.364(79), was adopted in December 2022. These guidelines further amended the calculation methodology and supersede the 2018 Guidelines on the method of Calculation of the Attained Energy Efficiency (EEDI) for New Ships, Resolution MEPC. 308(73).

### **The 2021 Guidance on Treatment of Innovative Energy Efficiency Technologies for Calculation and Verification of the Attained EEDI and EEXI, MEPC.1/Circ. 896**

#### *General*

The 2021 Guidance on Treatment of Innovative Energy Efficiency Technologies for Calculation and Verification of the Attained EEDI and EEXI, MEPC.1/Circ. 896, was approved in Nov 2021 at MEPC 77<sup>th</sup> session. This was an update of MEPC.1/Circ.815, published in 2013 and aims to assist manufacturers, shipbuilders, shipowners, verifiers and other interested parties relating to EEDI and EEXI of ships to treat innovative energy-efficiency technologies for calculation and verification of the attained EEDI, in accordance with regulations 5, 6, 7, 8, 9 and 20 of Annex VI to MARPOL (Guidance on Treatment of Innovative Energy Efficiency Technologies for Calculation and Verification of the Attained EEDI and EEXI, MEPC.1/Circ 896, 2021).

#### *Category of Innovative Energy Efficiency Technologies*

As per (Guidance on Treatment of Innovative Energy Efficiency Technologies for Calculation and Verification of the Attained EEDI and EEXI, MEPC.1/Circ 896, 2021), the regulation divides the innovative energy-efficiency technologies into categories (A), (B) and (C), depending on their characteristics and effects to the EEDI formula. Furthermore, Category (B) and Category (C) are categorised into two sub-categories, (B-1) and (B-2), and (C-1) and (C-2). WAPS is allocated to Category (B-2).



**“Category (A):** Technologies that shift the power curve, which results in the change of combination of  $P_P$  and  $V_{ref}$  : e.g., when  $V_{ref}$  is kept constant,  $P_P$  will be reduced, and when  $P_P$  is kept constant,  $V_{ref}$  will be increased.

**Category (B):** Technologies that reduce the propulsion power,  $P_P$ , at  $V_{ref}$ , but do not generate electricity. The saved energy is counted as  $P_{eff}$ .

**Category (B-1):** Technologies which can be used at any time during the operation and thus the availability factor ( $f_{eff}$ ) should be treated as 1.00.

**Category (B-2):** Technologies which can be used at their full output only under limited conditions. The setting of availability factor ( $f_{eff}$ ) should be less than 1.00.

**Category (C):** Technologies that generate electricity. The saved energy is counted as  $P_{AEff}$ .

**Category (C-1):** Technologies which can be used at any time during the operation and thus the availability factor ( $f_{eff}$ ) should be treated as 1.00.

**Category (C-2):** Technologies which can be used at their full output only under limited conditions. The setting of availability factor ( $f_{eff}$ ) should be less than 1.00”

*Consideration of WAPS impact for the EEDI Calculation*

The impact of WAPS on calculation is to be considered according to the formula below:

$$\frac{(\prod_{i=1}^M f_j)(\sum_{i=1}^{nME} P_{ME(i)} C_{FME(i)} \cdot SFC_{ME(i)}) + (P_{AE} \cdot C_{FAE} \cdot SFC_{AE} *) + ((\prod_{j=1}^M f_j \cdot \sum_{i=1}^{nPTI} P_{PTI(i)} - \sum_{i=1}^{neff} f_{eff(i)} \cdot P_{AEff(i)}) C_{FAE} \cdot SFC_{AE}) - (\sum_{i=1}^{neff} f_{eff(i)} \cdot P_{eff(i)} \cdot C_{FME} \cdot SFC_{ME} **)}{f_i \cdot f_c \cdot Capacity \cdot f_w \cdot V_{ref}}$$

Where  $(f_{eff} \cdot P_{eff})$  is the available effective power in kW delivered by the specified WAPS and is to be calculated by the formula below.

$$(f_{eff} \cdot P_{eff}) = \left( \frac{1}{\sum_{k=1}^q W_k} \right) \cdot \left( \left( \frac{0.5144 \cdot V_{ref}}{\eta_D} \sum_{k=1}^q F(V_{ref})_k \cdot W_k \right) - \left( \sum_{k=1}^q P(V_{ref})_k \cdot W_k \right) \right)$$

The force matrix  $F(V_{ref})_k$  and global wind-probability matrix  $P(V_{ref})_k$  are the two key components in the above formula.

The global wind probability may generate conservative gains of EEDI as it is not representative of the vessel’s intended routes. For example, according to the case study of a VLCC in document MEPC 74/INF.39, the attained EEDI increases to 35.5% from 21.1% when using the global wind-probability matrix instead of the matrix of the vessel’s intended trading routes. This is because the global wind matrix includes routes with a low probability of wind. Table 21 below shows the detailed comparison of the attained EEDI using different wind matrices (Air Pollution and Energy Efficiency, Findings on the EEDI Assessment Framework for Wind Propulsion Systems, MEPC 74/INF.39, 2019).

Table 21. Comparison of the Attained EEDI using Different Wind Matrix.

	Attained EEDI	Below the baseline value
No sails	2.061	19.5%
With sails	2.027 (global wind matrix)	21.1%
With sails	1.888 (wind matrix for vessel’s intended route)	35.5%

To address the issue described above, a decision was taken at MEPC 77 to boost the effectiveness of wind, since the savings using the global wind matrix were quite small; there are some additional conditions to the



formula shown above so that only the sum of the highest  $\frac{1}{2}$  of the matrix is used, which increases the contribution of WAPS. This has been a good addition to the methodology in MEPC.1/Circ. 896.

Currently, there are on-going industry discussions and studies on how to further improve the methodology, and how to use these two matrices. The force matrix  $F(V_{ref})_k$  can be decided by various methods according to the vessels' intended operating profile, such as wind tunnel model tests, CFD/numerical calculations and full-scale tests. However, there are no guidelines to verify the methodology used to derive the force matrix, which causes large uncertainty for the power calculation. Moreover, there is a strong possibility that the EEDI reference speed is neglected when generating the force matrix (Decarbonisation of Shipping - Technical Study on the Future of the Ship Energy Efficiency Design Index, European Commission, 2021).

Apart from the matrices, the whole concept has been challenged. It is recognised that while the EEDI refers to a speed ( $V_{ref}$ ) under calm sea conditions, the savings from WAPS are realised under windy conditions, creating a contradictory part in the regulation. Also, under such weather conditions, the vessel also will encounter waves, creating an additional wave-resistance component, and resulting in increased power demand. This component is not captured under MEPC.1/Circ.896 and this may result in overestimating the positive effect of WAPS on the attained EEDI. Additionally, it is noted that some clarifications are needed regarding the definition of wind propulsion coefficients. The lift and drag coefficients of the WAPS must be determined via a wind tunnel test or numerical calculation of the WAPS configuration, without the vessel. Finally, the Circular does not require the user to verify WAPS in a trial, which is the main concept in the EEDI framework.

The industry is making efforts to improve further this calculation and verification methodology. WiSP2 JIP launched by Maritime Research Institute Netherlands (MARIN) and American Bureau of Shipping is investigating methods to ensure transparent performance predictions for ships with WAPS (WiSP2 Wind Assisted Propulsion, 2021). The WiSP3 JIP is expected to commence in November 2023, working on the standardization of performance predictions of wind-assisted ships and updates to the regulatory framework.

A workstream of the European Sustainable Ship Forum (ESSF) is dedicated to WAPS and has worked on the continuous development of the EEDI assessments for ships with WAPS. Also, an informal working group was assembled to further discuss the latest guideline for considering the innovative technologies to EEDI and EEXI, document MEPC.1/Circ.896 (Reduction of GHG Emissions from Ships, Wind Propulsion, MEPC 79/INF.21, 2022).

Prior to the publication of the MEPC.1/Circ. 896, ABS had conducted sensitivity studies using two vessels -- one with sail and one with rotor sails -- to investigate the impact of the number of wind angles and wind speeds to the EEDI index. The findings of the studies show that the EEDI is very sensitive to the number of wind directions and wind speeds used for the calculation. The results also show that a combination of angles and wind speed can be found for both cases that achieve an EEDI rating comparable to the reference case where the global wind-probability matrix is used. Thus, it is concluded that it may be possible to use a certain number of fixed wind angles and wind speeds as an alternative to global wind matrix for the EEDI calculation. (Decarbonisation of Shipping - Technical Study on the Future of the Ship Energy Efficiency Design Index, European Commission, 2021)

The above analysis is applicable for both EEDI and EEXI.

### **The 2022 Guidelines on Survey and Certification of the Energy Efficiency Design Index (EEDI), MEPC.365(79)**

The 2022 Guidelines on Survey and Certification of the EEDI, MEPC.365(79), was adopted in December 2022. These guidelines aim to assist EEDI verifiers to conduct the survey and certification in accordance with regulations 5, 6, 7, 8 and 9 of MARPOL Annex VI. In addition, they also help marine communities to understand the procedures for the survey and certification of the EEDI (2022 Guidelines on Survey and Certification of the Energy Efficiency Design Index (EEDI), MEPC.365(79), 2022).

According to the guidelines, the survey and certification of the EEDI should be conducted in two stages: preliminary verification at the design stage by carrying out a witnessed model tank test and final verification of the ship's speed at the sea trial. The basic flow of the survey and certification process is found in MEPC.365(79),

2022. (2022 Guidelines on Survey and Certification of the Energy Efficiency Design Index (EEDI), MEPC.365(79), 2022).

These guidelines are used to verify the EEDI speed ( $V_{ref}$ ) at 75% MCR without taking the WAPS into account. The impact of WAPS is only accounted for by estimating the emission reduction by the reduction in propulsion power based on MEPC.1/Circ. 896, which, as mentioned above, does not require the WAPS to be verified in a trial. Therefore, the guidelines could be updated to facilitate the adoption of the WAPS.

As EEDI is a critical component in assessing the performance of WAPS, a complete methodology of EEDI calculation and verification is crucial to their adoption.

Another concern is whether vessels with WAPS that show substantial savings could be excluded from EEDI; on these vessels the design modifications could be significant, and the level of uncertainty in the calculations will be high (Decarbonisation of Shipping - Technical Study on the Future of the Ship Energy Efficiency Design Index, European Commission, 2021). A practical example of WAPS with high savings are vessels that might not reach the 75% of MCR that is required for the definition of  $V_{ref}$ . (The 2022 Guidelines on Survey and Certification of the Energy Efficiency Design Index (EEDI), MEPC.365(79), 2022).

Finally, it should be noted that in MARPOL Annex VI and EEDI Guidelines, the definition of non-conventional and hybrid propulsion is not clear yet and should be clarified.

As per Regulation 2.19:

*“Non-conventional propulsion in relation to chapter 4 of this Annex means a method of propulsion, other than conventional propulsions, including diesel-electric propulsion, turbine propulsion, and hybrid propulsion systems.”*

According to Regulation 19.3:

*“Regulations 22, 23, 24 and 25 of this Annex shall not apply to ships which have non-conventional propulsion, except that regulations 22 and 24 shall apply to cruise passenger ships having non-conventional propulsion and LNG carriers having conventional or non-conventional propulsion, delivered on or after 1 September 2019, as defined in regulation 2.2.1, and regulations 23 and 25 shall apply to cruise passenger ships having non-conventional propulsion and LNG carriers having conventional or non-conventional propulsion.”*

WAPS could fall into the non-conventional propulsion category (which includes hybrid-propulsion systems) and, if so, as noted above, vessels with WAPS could be excluded from the EEDI and the EEXI. However, while several attempts have been made to define hybrid propulsion, a formal definition of a hybrid propulsion system is currently missing.

Back in 2009, in GHG-WG 2/2/12, the hybrid propulsion was defined as systems with shaft motors, shaft generators or waste heat-recovery systems. In 2010, in EE-WG 1/3, it was suggested that hybrid propulsion could include ships with main engines (i.e., conventional propulsion) and PTI motors with gear boxes, as well as ships with gas turbines operating as auxiliary power generators. In that respect, looking at the origin of the term hybrid propulsion system, this refers to a mix of conventional and non-conventional propulsion, i.e., a merger of electrical and mechanical sources of rotating energy.

MEPC 59/4/2 defines hybrid propulsion systems as ships with mixed or complex propulsion systems. Since then, there have been a lot of developments in the guidelines for EEDI/EEXI calculation, which include cruise ships with diesel-electric propulsion and LNG carriers with both steam turbine and diesel-electric propulsion; this recognises these configurations as hybrid, as per Regulation 2.19 of Annex VI. Another definition proposed can be found in MEPC 74 INF.20, which suggests that hybrid means battery hybrid.

Given the above inconsistencies, the IMO should provide a clear definition of the term “hybrid-propulsion system”. For WAPS, this could be that vessel achieves a specific speed solely from using WAPS, or a specific amount of savings; in such cases, these vessels can be exempted from those regulations.

### **Guidelines for determining minimum propulsion power to maintain the manoeuvrability of ships in adverse conditions, MEPC.1/Circ.850**

The guidelines offered within MEPC.1/Circ.850 were approved in June 2021. It is an amended version of the 2013 Interim Guidelines for determining minimum propulsion power to maintain the manoeuvrability of ships in adverse conditions. They are applicable to tankers, bulk carriers and combination carriers, the types of ships for which is most critical to have sufficient power to manoeuvre in adverse conditions. The guidelines are not applicable to ships with non-conventional propulsion systems, such as pod propulsion.

The guidelines were made to help Administrations and recognised organisations to verify that any ships in compliance with the requirements of the EEDI have sufficient installed propulsion power to maintain the manoeuvrability in adverse conditions that is required for safe operations (Guidelines for Determining Minimum Propulsion Power to Maintain the Maneuverability of Ships in Adverse Conditions, MEPC.1/Circ.850, 2021). As stated in regulation 24.5, Chapter 4 of MARPOL Annex VI: “For each ship to which this regulation applies, the installed propulsion power shall not be less than the propulsion power needed to maintain the manoeuvrability of the ship under adverse conditions as defined in the guidelines to be developed by the Organization.”

The MPP (Minimum Propulsion Power) assessment is carried out on two different levels: a minimum power lines assessment and a minimum power assessment. The ships that fulfill either of those two options are considered to have sufficient power.

When a WAPS is installed, it is expected to partly cover the ship’s power needs. However, since MPP will be part of EEDI verification for safety considerations, installed power cannot be significantly reduced.

Reducing installed power would make sense in terms of investment and would further reduce the vessel’s EEDI. On the other hand, there is the view that MPP guidelines are applicable to WAPS vessels without modification because those systems are switched off and/or stowed in adverse conditions. ‘Adverse conditions’ include head winds, which offer no benefit to the WAPS. In parallel, the MPP guidelines would need to clarify whether the windage area from a WAPS should be accounted for. Adding a WAPS may increase the need for installed power, due to the increase in the windage; this can counteract the reduction wind power and impact the attained EEDI.

Overall, the regulation needs further refinement to clarify the issues above and to support the development of a uniform methodology for calculating the EEDI and MPP (Decarbonisation of Shipping - Technical Study on the Future of the Ship Energy Efficiency Design Index, European Commission, 2021).

### **3.1.3 Other Related Regulations**

#### **Convention on the International Regulations for Preventing Collisions at Sea 1972**

The Convention on the International Regulations for Preventing Collisions at Sea 1972 was adopted on 20 Oct 1972, and it entered into force on 15 July 1977. This regulation provides detailed requirements for the types and locations of the navigational lights installed on ships. It also provides alternative solutions when the principle method is not practical, including the addition of masthead lighting and all-round lighting. The regulation has five parts and four annexes; Part C provides criteria for the lights’ visibility, and Annex I covers the positioning and technical details of lights and shapes. Annex I/9 horizontal sectors states:

*(b) (i) All-round lights shall be so located as not to be obscured by masts, topmasts or structures within angular sectors of more than 6°, except anchor lights prescribed in Rule 30, which need not be placed at an impracticable height above the hull.*

*(ii) If it is impracticable to comply with paragraph (b)(i) of this section by exhibiting only one all-round light, two all-round lights shall be used, suitably positioned or screened so that they appear, as far as practicable, as one*

*light at a distance of one mile* (Convention on the International Regulations for Preventing Collisions at Sea 1972 ).

Some types of WAPS could have a large sail area large which will block the navigational lights. Specific guidelines will need to be developed for accepting alternative methods for safe navigation if the navigational lights are blocked by the WAPS.

## 3.2 International Association of Classification Societies (IACS)

Classification societies play an active role in assuring the safety of life, property and the environment. The collective members of IACS make a unique contribution to maritime safety and regulation by providing technical support, compliance verification (of statutory instruments in their role as Recognised Organisations), research and development. The collaboration of the many Classification Societies in IACS leads to the implementation of common rules, unified requirements (UR) for typical class rules, unified interpretations (UI) of statutory instruments and other recommendations.

Many major Classification Societies have introduced rules (listed below) to facilitate the adoption of WAPS.

- American Bureau of Shipping (ABS): ABS Guide for Wind Assisted Propulsion System Installation.
- Bureau Veritas (BV): BV NR 206 Wind Propulsion System.
- Det Norske Veritas (DNV): DNV-ST-0511, Wind Assisted Propulsion Systems and Pt 6-Ch 2-Sec 12, DNV-RU-SHIP, Wind Assisted Propulsion Systems.
- Lloyd's Register: LR Provisional Rules for Sail-Assisted Ships.
- Nippon Kaiji Kyokai: Class NK guidelines for Wind-Assisted Propulsion System for Ships.
- China Classification Society (CCS): Guidelines for Survey of Marine Wind-Rotor Assisted Propulsion System.
- Registro Italiano Navale (RINA): Rules for the Classification of Ships, Part F Additional Class Notations, Chapter 13 Other Additional Class Notations, Section 45 Wind Assisted Propulsion system.
- Korea Register (KR): Guidance for Prevention System of Pollution from Ships, Chapter 5, Wind Assisted Propulsion System.

### ABS Guide for Wind-Assisted Propulsion System Installation

#### *General*

The guide was published in August 2021. It applies to vessels that use WAPS as auxiliary propulsion, not to replace conventional propulsion. It focuses on two primary types of WAPS: Rotor sails and wing sails (including rigid sails and soft sails). It has four sections in total. Section 1 mainly covers the scope and application, terminology definitions and the documents to be submitted for the notation, etc. Section 2 provides additional requirements that are applicable to a more stringent Wind-Assisted+ notation. Section 3 provides the minimum class requirements for vessels having WAPS installed. Vessels fully complying with the requirements in this section may be assigned the optional Wind-Assisted notation at the request of the owner. Section 4 provides the survey requirements for a vessel fitted with a WAPS (ABS Guide for Wind Assisted Propulsion System Installation, 2021).

#### *Structural Loading*

Section 3/2.2 provides the detailed requirements for the loads and the foundation structures to be included in structural design calculations. In total, four types of loads are to be considered:

- Wind loads

The guide requires that the maximum wind-induced loads be considered for both normal-operating and survival conditions. The detailed input of the wind loads is specified by the manufacturer.

- Gravitational and inertial loads

Gravitational and inertial loads are loads caused by vessel motion and the weight of the WAPS. The acceleration values of these loads are to be determined and used for the load consideration during vessel design.

- Loads due to snow and ice

The guide states: "*Where ice loads are to be included in the load consideration, the impact of icing on both structural design and intact stability is to be determined and submitted by the manufacturer. In absence of specific details, the weight of ice in accordance with 3-3-A3/11.11 of the Marine Vessel Rules may be used as a minimum.*"

- Green sea loads

The guide requires that the 'green sea load' be considered for the survival condition. The detailed load methodology is referred to Part 5 of ABS Marine Vessel Rules.

For Classification Societies that have not published specific requirements for WAPS, the load calculations use the general rule sets for lifting appliances. The load consideration for WAPS is similar to that of lifting appliances due to similar installation location and environmental conditions to which the system is exposed.

The requirements for load consideration provided by the class rules are a guideline for adopting WAPS technology. However, as there are many new types of WAPS in design, class should keep refining their rules, as more refined guidelines -- including customised load determinations for different types of WAPS -- would be beneficial.

### *Materials*

The requirements for materials are stated in Section 2/2.2, which mainly refers to the general rule sets.

*The materials used in the construction of the wind-assisted propulsion system are to be suitable for the intended service conditions. The materials used in the construction of the WAPS are not required to be manufactured at steel works approved by ABS and tests are not required to be conducted in the presence of an ABS Surveyor. Material certificates are to be provided at the request of an ABS Surveyor, in accordance with Chapter 2, Section 3 of the Lifting Appliances Guide.*

The class requirements for material certification of WAPS are general and more refined guidelines, including for the certification of the materials for various types of systems, would be beneficial.

### *Mooring Equipment*

As per Section 3/6, the additional side-projected area and weight introduced when installing WAPS should be considered when determining the equipment number (EN) for anchoring and mooring equipment. There is no significant gap in the requirements for mooring equipment when adopting WAPS technology.

### *Electrical Systems*

The requirements of electrical systems are well-established in Class rules; these can be applied to WAPS as well. Section 2/3 indicates the rule sets for the requirements of the electrical systems for WAPS.



*The electrical systems for WAPS are to be in accordance with Part 4, Chapter 8 of the Marine Vessel Rules applicable to non-essential systems. Where installed, hydraulic systems, including the piping systems, are to be in accordance with Part 4, Chapter 6 of the Marine Vessel Rules.*

#### *Crew Safety*

The requirements for crew safety are well established and there is no significant gap for the adoption of WAPS technology. The requirements are indicated in Section 3/9.2, which mainly refers to the general rule sets.

*Measures are to exist to protect the crew from the potential hazards from the moving and rotating parts of the [WAPS] by providing safe passage. If no measure exists, the installation is to be made in accordance to 3-2-17/3 of the Marine Vessel Rules.*

#### *Lightning Protection*

As per Section 3/9.3, the WAPS should be protected from lightning. The detailed requirements are referred to in 4-8-5/9.7 of ABS Marine Vessel Rules. The requirements for lightning protection are applicable to ships with WAPS and there is no significant gap for their adoption.

#### *Survey and Testing*

The minimum class requirements require the foundation structure of WAPS to be tested and examined by the manufacturer. The materials used for the foundation structure are to be certified by ABS. Non-destructive testing (NDT) should be conducted on the critical welds on the foundational steel structure.

Ships may apply for a more advanced notation, **Wind-Assisted+**, for which there are additional class requirements beyond the minimum. It is required that all WAPS, including all load-bearing support structural members, be surveyed during construction. The testing of all structural components and assembled components of the WAPS are to be witnessed and reported by the attending surveyor. NDT is for welds on the critical steel structure on the support and thrust-generating members in accordance with the ABS Guide for Non-destructive Inspection or other recognised codes. Also, the drive units of WAPS should be certified and tested.

The detailed survey verification items during construction and sea trial requirements are illustrated in Section 4/3 of the Guide. The survey after construction requirements are referred to the general rule set in ABS Rules for Survey after Construction, Part 7.

## **BV NR 206 Wind Propulsion System**

### *General*

This rule note was published in Feb 2021. It is applicable to wind propulsion systems fitted onboard ships. It covers:

- Requirements for granting an additional class notation WPS1 or WPS2 to a ship fitted with a wind propulsion system complying with the requirement of this rule note (Sec 2)
- Certification of equipment and accessories associated to the wind propulsion system (Sec 3 and App 2) Materials and equipment used for the construction of wind propulsion systems (Sec 4)
- Design conditions and loads considered for the wind propulsion system (Sec 5)
- Scantling check of the standing rigging structure (Sec 6) and the running rigging structure (Sec 7)
- Assessment of the drive systems (Sec 8)
- Assessment of the parts of the ship affected by the propulsion systems ([1.1.3] and Sec 9).
- Sea trials, initial inspection and testing (Sec 10)

- In-service surveys (Sec 11)
- Guidelines for calculation of EEDI (Appendix 1)
- Requirements for a survey of materials and equipment (see Appendix 2) (BV NR 206 Wind Propulsion System, 2021)

#### *Structural Loads*

Section 5/4 requires that the overall loads exerted on the WAPS should be specified by the designer. Three load cases are to be considered to maximise the combined acceleration of the longitudinal, transversal and vertical accelerations, which include head sea, beam sea and forward oblique sea. In addition, the note also provides guideline for using the envelope-acceleration values for preliminary assessment when the values of the accelerations are not provided by the designer.

#### *Materials*

Section 4 provides the detailed requirements for the materials of WAPS, including:

- materials used for the construction of mast, boom, spreader, yards, cylinder for rotor sail or suction wings and rotating systems, when relevant.
- rope materials used for the mast rigging (steel wire rope, steel rod, synthetic fibres) and their terminals and accessories.

#### *Mooring Equipment*

Section 9/5.3 provides the requirements for equipment in anchors and chains for mooring, which are based on the approaches to hypothesis calculation defined in the general rule sets NR 457 and NR600.

#### *Electrical Systems*

Section 8/4 provides the requirements for the drive units' electrical systems. It requires that electric motors, equipment and cables are to be protected against overcurrent, ingress of liquids, ingress of solid foreign bodies, moisture and corrosion in sea-water atmospheres and accidental shocks. The detailed guideline of protection against ingress of liquids and solid bodies are referred to the general rule sets NR 467.

#### *Lightning Protection*

Section 9/7.2 provides the requirements for lightning and earth protection.

*A protective system is to be fitted to structure of non-metallic construction or having a substantial number of non-metallic members. The lightning and earthing system is to be designed in accordance with the requirements of IEC60092-401.*

#### *Survey and Testing*

Section 10 provides general guidelines for the requirements related to initial surveys and sea trials. It requires that a list of shipboard tests is to be submitted and witnessed by a surveyor. The final test results and reports are to be verified by the Classification Society. Section 11 provides general procedures for in-service surveys, including class-renewal and annual surveys.

### **DNV Pt 6-Ch 2-Sec 12, DNV-RU-SHIP, Wind Assisted Propulsion Systems**



This part of the rule provides a general procedure to obtain an optional class notation for WAPS on ships. The detailed requirements are referred to DNV-ST-0511, Wind Assisted Propulsion Systems (Pt 6-Ch 2-Sec 12, DNV-RU-SHIP, Wind Assisted Propulsion Systems).

#### DNV-ST-0511, Wind Assisted Propulsion Systems

The standard was first published in Nov 2019 and amended in Oct 2021 and covers the following scope:

- technical requirements for the design and construction of a wind-assisted propulsion unit (Sec 2)
- procedural requirements to be followed upon certification and classification of a WAPS for installation onboard a ship (Section 3)
- physical principles and associated safety considerations (Appendix A)
- EEDI energy efficiency certification (Appendix B) (DNV-ST-0511, Wind Assisted Propulsion Systems, 2021).

#### *Structural Loads*

Section 2.4 provides detailed guidelines for consideration of structural loads. Both regular service loads and extreme loads need to be taken into consideration. The regular service loads mainly consider wind loads and inertia loads. The extreme loads mainly consider wind loads, snow and ice loads, green-sea loads, thermal loads and other extreme loads.

#### *Materials*

The material requirements refer to the general rule set DNV-RU-SHIP Pt.2. There are no other specific requirements for WAPS.

#### *Electrical Systems*

All the requirements for the electrical systems are referenced to the general rule set; there are no other specific additional requirements for WAPS. As per Section 3.3.5 of the standard:

- *All electrical equipment serving essential or important services shall be delivered with DNV product certificate and/DNV type-approval certificate as required by DNV-RU-SHIP Pt.4 Ch.8 Sec.3 Table 3.*
- *Control system shall be handled as important control system, as per DNV-RUSHIP Pt.4 Ch.9.*

### **LR Provisional Rules for Sail Assisted Ships**

LR Provisional Rules for Sail Assisted Ships was published in July 2021 and are applicable to sea-going ships incorporating sails or other wind propulsion generating devices which are not intended as the primary means of propulsion. It covers a variety of design considerations, requirements of structural arrangements, survey requirements for sails systems, etc (LR Provisional Rules for Sail Assisted Ships , 2021). These are general guidelines and do not provide detailed methods for load consideration, material certification, etc.

### **Class NK guidelines for Wind-Assisted Propulsion System for Ships**

#### General

The guidelines were published in April 2023. They regulate not only the design of WAPS, but also the design of base ship which is affected by the installation of WAPS. The document covers the requirements for:

- risk assessment (Chapter 2)
- loads cases determination and loads calculation (Chapter 3)
- structure design (Chapter 4)
- materials and joints (Chapter 5)
- design of base ship (Chapter 6)
- operation and maintenance (Chapter 7)
- effect on hull construction (Chapter 8)
- effect on stability manoeuvrability and ship speed (Chapter 9)
- blind sectors due to WAPS (Chapter 10)
- fire safety, operation and others (Chapter 11)
- surveys (Chapter 12) (Class NK Guidelines for Wind-Assisted Propulsion System for Ships, 2019).

### *Structural Loads*

Chapter 3 provides requirements for load considerations. Class NK requires that at least three load cases be considered – in-service condition, standby condition and abnormal condition. The loads to be considered are: aerodynamic loads, gravitational and inertial loads, and other loads such as green-sea loads, impact loads, ice loads, etc.

### *Materials*

Section 5.1 provides requirements for different types of materials used for the WAPS, which mainly refer to the general rule sets including Rules for the Survey and Construction of Steel Ships and Rules for the Survey and Construction of Ships of Fiberglass Reinforced Plastics.

### *Electrical Systems*

As per Chapter 6.2, the requirements for the electrical systems are to be referred to the general rule sets Part D and Part H of the Rules for the Survey and Construction of Steel Ships.

### *Crew Safety*

The crew safety issue is not directly discussed in the document, while Chapter 7 states that the operational manual should be referenced to ensure the crew operates the WAPS safely.

### *Survey and Testing*

The survey requirements are indicated in Chapter 12 of the guidelines, covering product, installation and periodical surveys for WAPS. The product surveys require their structure and components to be manufactured in good order according to general set requirements. The installation surveys mainly cover the examination of workmanship, stability experiments, onboard tests and the verification of sea trials. The periodical surveys for WAPS need to be conducted in conjunction with the ship's annual, intermediate and special surveys.

## **CCS Guidelines for Survey of Marine Wind-Rotor Assisted Propulsion Systems**

### *General*

The guidelines were published in Feb 2023. The document is applicable to sea-going ships installed with rotor sails, and covers these requirements:

- Ship design requirements, including general arrangement, strength, stability, etc. (Chapter 2)
- Construction requirements for rotor sails (Chapter 3)
- Drive- and alarm-system design requirements for rotor sails (Chapter 4)
- Survey requirements (Chapter 5)
- EEDI/EEXI calculation and verification (Chapter 6) (CCS Guidelines for Survey of Marine Wind-Rotor Assisted Propulsion System, 2023)

### *Structural Loads*

Section 3.4 provides requirements for considering the loads acting on the rotor sail, including wind loads, inertial force loads, ice and snow loads and green-sea loads. The maximum wind load and wind direction under normal operating conditions and self-storage conditions should be submitted by the designer, as should the inertia loads. This section indicates the minimum requirements for the acceleration values to be considered for various types of ships. The ice and snow loads need to be considered when ships navigate in an ice area. Green-sea loads need to be considered under the self-storage conditions.

### *Materials*

As per section 3.2, the requirements for metal materials are to be referred to the general rule set – Part 1 and Part 3 of Rules for Materials and Welding. The requirements for fibre, resin, core materials and other non-metallic materials are to be referred to Chapter 2, Part 2 of the Rules for Materials and Welding.

### *Electrical Systems*

The requirements for electrical system are referred to the general rule set - Chapter 2, Part 4 of Rules for Classification of Sea-going Steel Ships.

### *Lightning Protection*

Section 2.2.9 provides requirements for lightning protection, which mainly referred to general rule sets.

*The wind rotor-assisted propulsion system is to be so installed to be capable of reducing the indirect damage effect on the electrical system caused by lightning stroke. The metal shell of the equipment is to be reliably grounded and meet the relevant requirements of Section 13 Chapter 2, Part Four of CCS Rules for Classification of Sea-going Steel Ships.*

### *Survey and Testing*

The survey requirements during construction are indicated in Section 5.2, which requires WAPS to be tested at a workshop before testing onboard the ship. The following items are to be checked by the surveyor:

- Supporting structures for WAPS and deck connections
- The installation of mechanical devices, piping and electrical equipment
- Lightning-protection measures
- The availability of a manual for operation and maintenance

- NDT for structural welds
- Functional test for WAPS
- Sea-trial verification to ensure that normal operations of the ship are not affected by WAPS.

The annual- and special-survey requirements are indicated in Section 5.3.

## **RINA Rules for the Classification of Ships, Part F Additional Class Notations, Chapter 13 Other Additional Class Notations, Section 45 Wind Assisted Propulsion system (WAPS)**

### *General*

The document was published in May 2023 and came into force in June 2023. It provides requirements on the design, installation and testing of WAPS for new and existing ships. This section is applicable to all types of WAPS including sails, rotor sails and wind turbines. Three types of notations are provided – **WAPS-A**, **WAPS-H** and **WAPS-M**. **WAPS-A** is for WAPS contributing at most 15% of the propulsion power. **WAPS-H** is for WAPS contributing 15-60% of propulsion power. **WAPS-M** is for systems contributing more than 60% of propulsion power.

### *Structural Loading*

For the connections of the WAPS to the outer hull plating, ordinary stiffeners and/or primary supporting members, the hull-girder loads need to be considered. For the scantling of main WAPS components and the connecting structural elements, the WAPS loads, acceleration loads, accidental loads set(s) from the scenario(s) and resulting additional hull-girder loads applied by the WAPS to the hull all need to be considered,

### *Materials*

The requirements for materials are stated in Paragraph 2.1.3, which mainly refers to the general rule sets.

*The characteristics of the steel or aluminium materials to be used in the construction of WAPS components (e.g., masts, booms, wings, rotors) are to be according to the requirements available in Pt B, Ch 4, Sec 1. The use of composite materials for blades, wings and sails and other components may be accepted case-by-case if these are type-approved according to the RINA "Rules for the Type Approval of Components of Composite Materials Intended for Hull Construction".*

### *Electrical Systems*

The requirements of electrical systems mainly refer to the general rule set, Pt C, Ch1, Sec 10 and Pt C, Ch 1, Sec14.

### *Survey and Testing*

The following tests need to be performed before sea trials:

- *WAPS piping system tightness tests, according to Pt C, Ch 1, Sec 10*
- *WAPS automation commissioning, according to Pt C, Ch 3, Sec 6*
- *WAPS electrical installation insulation resistance and earth, according to Pt C, Ch 2, Sec 15*
- *WAPS machinery items functioning tests.*

During the sea trial, these tests are to be conducted:

- *recording of performances with WAPS on (active) and off (tilted or retracted) during navigation at established service speed of ship*
- *all operational modes and configurations of WAPS foreseen during navigation*
- *manoeuvrability tests with WAPS on (active) and off (tilted or retracted)*
- *emergency stop/shutdown of WAPS elements from control station according to [2.5.4]. (Registro Italiano Navale, Rules for the Classification of Ships, Part F Additional Class Notations, 2023)*

## **KR Guidance for Prevention System of Pollution from Ships, Chapter 5, Wind Assisted Propulsion System**

### *General*

This chapter was published in July 2022. It is applicable to ships equipped with two types of WAPS – rotor sails or wing sails -- and provides requirements for the basic notation **ES-Wind** and the more advanced notation **ES-Wind1**. Section 3 provides the basic requirements for **ES-Wind** notation. Section 4 provides additional requirements for **ES-Wind1** notation. Section 2 provides survey requirements.

### *Structural Loading*

Paragraph 304 provides the detailed requirements for the loads and the foundation structures to be included when calculating structural designs. Two categories of loads are to be considered in the design calculations – normal operating and extreme loads. The normal operating loads mainly include wind loads and inertia loads; the extreme loads mainly include wind, snow and ice, and green-sea loads.

### *Materials*

Paragraph 302 requires that the materials be in accordance with the general rule set, Pt 2 of the Rules for the Classification of Steel ships. Paragraph 403 requires that the materials used for the WAPS are to be suitable for the intended service conditions.

### *Mooring Equipment*

As per paragraph 3.11, the additional lateral projected area and weight caused by WAPS are to be considered to determine the EN for anchoring and mooring equipment.

### *Electrical Systems*

Paragraph 312 requires the electrical systems for WAPS to comply with the requirements of the general rule set, Pt 6, Ch 1 of Rules for the Classification of Steel Ships.

### *Crew Safety*

Paragraph 315 states that the crew is to be protected from the potential hazards of moving and rotating parts of the WAPS by providing safe passage.

### *Survey and Testing*

Section 2 provides detailed guidelines for the survey and testing requirements covering product, installation, annual and special surveys. (Korea Register, Guidance for Prevention System of Pollution from Ships, 2022).

The Class Societies' requirements could be further updated to better facilitate the adoption of WAPS in the following ways:

- Class requirements for the various WAPS could be harmonised and updated to include the certification of materials.
- It should be evaluated whether Class Societies need to create a UR to cover some key aspects for WAPS, including structural loads, materials, electrical systems, crew safety, lightning protection, survey and testing, etc.
- Comprehensive guidelines need to be developed to provide customised requirements for load determination for the different types of WAPS. The load determination depends on the types of systems and the locations where they are installed.
- The IMO's regulations for stability, manoeuvrability and course-keeping, bridge visibility and safe navigation and EEDI calculation and verification need to be amended to take the WAPS into consideration. Class rules and guides will need to be checked periodically to maintain consistency with emerging IMO regulation.
- IACS could evaluate whether it needs to submit proposals to the IMO for amendments to SOLAS or MARPOL, or to request clarifications about implementing the present guidelines for ships with WAPS.

### 3.3 International Organization for Standardization (ISO)

#### **Ships and marine technology — Guidelines for the assessment of speed and power performance by analysis of speed-trial data, ISO 15016:2015**

These guidelines were first published in 2002 and amended in 2015. The standards define and specify the procedures for the preparation, execution, analysis and reporting of speed trials for ships. The results of sea trial are used to determine a ship's performance in terms of speed, power and propeller-shaft speed under prescribed conditions that verify ship's speed in line with EEDI regulations and/or contracts (Guidelines for the Assessment of Speed and Power Performance by Analysis of Speed Trial Data, ISO 15016:2015).

The procedures prescribed in the ISO standards do not consider the impact of WAPS and the IMO has not issued formal guidelines on a method to verify their contribution to fuel efficiency during sea trials (Decarbonisation of Shipping - Technical Study on the Future of the Ship Energy Efficiency Design Index, European Commission, 2021).

Presently, there is no agreed standard or methodology in the marine industry to verify the EEDI performance of ships with WAPS; guidelines for the industry to follow are needed to encourage the adoption of these systems.

The industry faces several issues associated with developing comprehensive guidelines based on the present ISO standards:

- It is likely to be challenging to find the appropriate conditions for sea trials with the prescribed wind speeds. The waves associated with the aforementioned wind speeds are also expected to be significant and this is at odds with the requirements for good weather for sea trials.
- The appropriate calibration of the sensors is vital to correctly measure the wind conditions during sea-trial tests.
- Various wind angles are necessary to be considered to get a good overview of the potential gains (Decarbonisation of Shipping - Technical Study on the Future of the Ship Energy Efficiency Design Index, European Commission, 2021).

There are some on-going studies in the marine industry to develop guidelines. For example, a Specialist Committee for Wind Powered and Wind-Assisted Ships was established by the International Towing Tank Conference (ITTC) has been established to focus on:

- Reviewing technologies for wind propulsion and wind-assistance and clarifying the distinction between wind-powered and wind-assisted ships.
- Reviewing methods of hydrodynamic tests for ship models, wind-tunnel tests, CFD, ship-dynamic simulations and route selections to predict the performance and safety of wind-powered and wind-assisted ships at design stage; these would pay specific attention to higher side forces and ship drifts due to wind powering.
- Review long-term statistics of winds and waves from the applicability point of view to evaluate of wind-assisted ships at design stage.
- Deriving guidelines for predicting the fuel consumption of wind-propelled at the design stage, factoring in the effects of weather routing.
- Reviewing safety and regulatory issues related to hydro/aerodynamic testing and evaluation and recommending measures for the design stage.
- Deriving performance indicators for comparing the performance of wind propulsion at the design stage.
- Investigating the effect on propulsive factors from a reduced propeller load that arises from the use of wind power. Identify the effects of wind propulsion on the propulsion system, e.g., pressure side cavitation occurrence. Liaise with Resistance and Propulsion Committee and SC on Cavitation and Noise.
- Derive a modified procedure for full-scale trial of wind propulsion ships. Liaise with Full Scale Performance Committee.
- Cooperate with MEPC on the continuous development of the EEDI for wind propulsion ships. Liaise with Full Scale Ship Performance Committee.
- Liaise with the Ocean Engineering Committee regarding their work on software-in-the-loop and controllable fans to model wind loads. (Tasks and Structure of the 30th ITTC Technical Committees and Groups)

SSPA, part of the Research Institutes of Sweden, has conducted sea trials for three vessels with WAPS and proposed a methodology based on short sea trials for the EEDI verification of ships with WAPS. The first vessel is *Copenhagen*, a Ro-Pax hybrid ferry owned by Scandlines that features a 5x50 m<sup>2</sup> Norsepower rotor sail. The ship is 156.45 m in length and 24.6 m in breadth, operating from Gedser to Rostock.

The second vessel is *Annika Braren*, a bulk carrier owned by Rord Braren Bereederungs-GmbH & Co. and installed with a 3x18 m<sup>2</sup> Eco Flettner rotor. The vessel is of 84.95m in length and in breath of 15m, operating mainly in the North Sea region and the Baltic Sea.

The third vessel is *Frisian Sea*, a general cargo vessel owned by Boomsma Shipping. It is fitted with two 3x10 m<sup>2</sup> suction wings from Econowind. The vessel is of 118 m in length and in the breadth of 13.4 m, operating mainly in the North Sea region and Baltic Sea.

The sea-trial conditions for these vessels are shown in Table 22 (below). The tidal current was insignificant during the trials.

Table 22. Sea Trials Conditions.

	<b>Copenhagen</b>	<b>Annika Braren</b>	<b>Frisian Sea</b>
Trial date	March 6-7, 2021	September 25, 2021	October 11, 2021
Ship's Master	Alan Bach	Capt Mehrens	Oleksandr Pasatiuk
Location	South of Gedser	North of Gotland	South of Gotland



Wave height	1 m	0.7 – 1.5 m	1.7 m
Wave direction	W	NW	WSW
True wind speed	8-9 m/s	9-12 m/s	7-9 m/s
True wind direction	W	NW	SW

The trials were conducted as a series of short runs, with WAPS on and off. Short runs use less space and can be an advantage in areas with heavy traffic. After the trials, the data were corrected and processed via the following steps to attain the final estimates.

- The measured power for each single run was corrected for the resistance of the superstructure, according to the ISO/ITTC standard.
- The propulsive efficiency due to the added-resistance corrections and idling-rotor resistance was corrected, according to the ISO/ITTC standard.
- The effect of the WAPS was derived by comparing the runs with and without propulsor at the same wind angle.
- The results were normalised to consider the power loss for a given speed. The paper proposed two normalisation methods. One used the shape of the ship's speed power curve to extrapolate the nominal condition; the other one made use of a ship-simulation model, which was more complex.
- The average savings of fuel and CO<sub>2</sub> emission for a specific route of the ships were estimated by extrapolating the trial results using weather statistics and a Monte Carlo based voyage simulation tool.

The results show a large discrepancy between the measured performance and the theoretically expected performance, which was related to the wind angle in a specific way. This pattern was probably caused by the disturbance of the ships' freeboard and superstructure on the air flow over the wind propulsors. Thus, the paper believes that it is necessary to consider a range of wind directions during the verification of sea trials. In addition, it found that constant speed between runs does not necessarily reduce uncertainties related to the translation of a speed increase into a power loss. Thus, it recommends using constant power to verify full-scale sea trials.

According to the results of the three sea trials, the methodology proposed by SSPA was validated as a practical way for full-scale verification of EEDI for commercial vessels installed with WAPS, although some aspects still need to be further improved to derive more accurate results; these include the sensitivity and requirement for sensors, the sensitivity for parameters in the normalisation process, limitations for current variation and limiting wind conditions.

Aside the standardising the procedures for sea trials, the paper also suggests working on the uncertainty analysis and key-performance indicators. Identifying the uncertainty levels in the sea trials could help to guarantee the performance of WAPS during normal operations. There are many ways to represent the performance of WAPS, such as percentage of power reduction over a year, kW per mile, kW per hour, EEDI, power reduction at beam wind in a gale, etc. It would be beneficial to investigate the pros and cons of using different options as key performance indicators (Werner & Nisbet, 2022).

### 3.3.1 CAP 437 Standards for offshore helicopter landing areas

The first edition of CAP 437 was published in Sep 1981 to give guidance on the criteria for offshore helicopter-landing areas applied by the UK Civil Aviation Authority (CAA) for craft registered in the UK. The standards have gone through several amendments over the years, with the latest made in July 2021. They have become an accepted world-wide source of reference.

This document provides minimum requirements to achieve a clearance which will attract no helicopter performance (payload) limitations for different types of landing areas, including:

- fixed offshore installations;
- mobile offshore installations;
- vessels supporting offshore mineral exploitation;
- offshore wind farms; or
- other vessels such as tankers, cargo vessels and passenger vessels.

The criteria for the size of the physical landing areas are summarised in Table 23 (below) (CAP 437 Standards for Offshore Helicopter Landing Areas, 2021). The criteria are determined by the diameter of the helicopter's rotor and does not consider the impact of the WAPS. However, as some types of WAPS, such as rotor sails and sails, are of significant height, they might affect helicopter landings. It is recommended to assess the impact of those systems on the helicopter-landing area.

Table 23. Criteria for Helicopter Landing Areas

Type	D-Value (m) <sup>21</sup>	Perimeter 'D' marking	Helicopter rotor diameter (m)	MTOM (kg) <sup>22</sup>	't' value	Landing net size
Bolkow Bo 105D	12.00	12	9.90	2,400	2.4t	Not recommended
EC135	12.20	12	10.20	2,980	3.0t	Not recommended
AW109	13.05	13	11.93	2,600	2.6t	Small
BK 117/EC145	13.63	14	11.00	3,800	3.8t	Not recommended
Dauphin AS365 N2	13.68	14	11.93	4,250	4.3t	Small
Dauphin AS365 N3	13.73	14	11.94	4,300	4.3t	Small
EC155	14.30	14	12.60	4,920	4.9t	Medium
AW169	14.65	15	12.12	4,800	4.8t	Medium
Sikorsky S76	16.00	16	13.40	5,307	5.3t	Medium
AW139	16.62	17	13.80	6,800	6.8t	Medium

<sup>21</sup> Maximum size of the overall length of the helicopter landing area

<sup>22</sup> Maximum certificated take-off mass of the helicopter

Type	D-Value (m) <sup>21</sup>	Perimeter 'D' marking	Helicopter rotor diameter (m)	MTOM (kg) <sup>22</sup>	't' value	Landing net size
AW189	17.60	18	14.60	8,600	8.6t	Medium
EC175	18.06	18	14.80	7,800	7.8t	Medium
Super Puma AS332L	18.70	19	15.60	8,599	8.6t	Medium
Bell 214ST	18.95	19	15.85	7,938	7.9t	Medium
Super Puma AS332L2	19.50	20	16.20	9,300	9.3t	Medium
EC225	19.50	20	16.20	11,000	11.0t	Medium
Sikorsky S92A	20.88	21	17.17	12,565	12.6t	Large
Sikorsky S61N	22.20	22	18.90	9,298	9.3t	Large
AW101	22.80	23	18.60	15,600	15.6t	Large

### 3.4 Regulations for EU member states

On 14 July 2021, the European Commission presented 'Fit-for-55' (Figure 15 and Figure 16), a package of measures that seeks to align EU policies on climate, energy, land use, transport and taxation in such a way that the net GHG emissions can be reduced at least 55% by 2030, compared to 1990. It contains proposals for revising regulations and directives and some new policy initiatives.



Figure 15. The European Commission 'Fit-for-55' package.

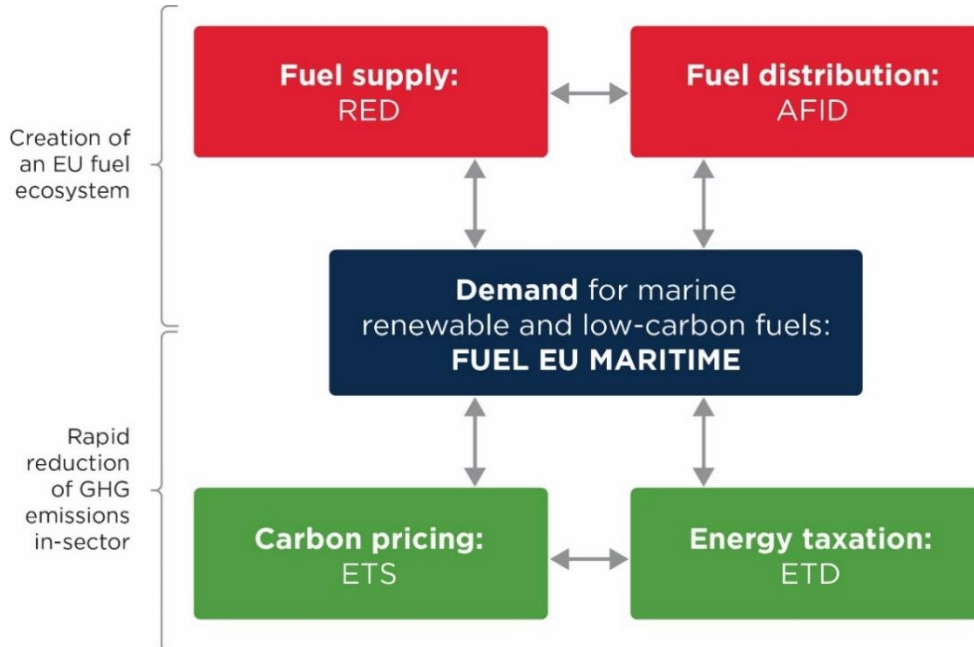

Figure 16. EU policies related to maritime transport.

**FuelEU Maritime**

As part of the 'Fit for 55' package, the EC launched the FuelEU Maritime Initiative. FuelEU Maritime sets a harmonised regulatory framework in the EU and aims to increase the share of renewable and low-carbon fuels

(RLF) used in the fuel mix of international maritime transport, including: liquid biofuels, e-liquids, decarbonised gas (including bio-LNG and e-gas), decarbonised hydrogen and its derived fuels (including methanol and ammonia) and electricity. Rewards are also given for substitute sources of energy.

The initiative will contribute to wider goals by pursuing specific objectives to:

1. Enhance predictability by setting a clear regulatory environment for the use of RLF in maritime transport.
2. Stimulate technology development.
3. Stimulate production on a larger scale of RLF with high technology readiness levels (TRLs) and reduce the price gap with current fuels and technologies.
4. Create demand from ship operators to bunker RLF or connect to electric grid while at berth.
5. Avoid carbon leakage.

FuelEU maritime will require ships of 5,000 GT and above to gradually reduce the GHG-intensity limits of energy used onboard against the 2020 benchmark average value (91.16 gCO<sub>2e</sub> by MJ) by:

- 2% as of 2025
- 6% as of 2030
- 14.5% as of 2035
- 31% as of 2040
- 62% as of 2045
- 80% as of 2050

This will cover 100% of the energy used on intra-EU voyages and 50% of the energy on ex-EU voyages. It is also noted that in 2028 the Commission will review whether the 5,000-GT threshold should be lowered and if the requirements of the regulation should be tightened.

Depending on the actual GHG intensity of a vessel compared to the target GHG intensity, a compliance balance will be calculated. If the compliance balance is negative, then a penalty in Euro will be calculated for each vessel. Positive compliance balance will create a surplus. It is noted that the compliance balance cannot turn to positive by only reducing the fuel consumption. Whether the compliance balance is positive or negative depends on the mix of fuels and energy sources.

Wind power has been recognised as a substitute source of energy and a reward factor ( $f_{wind}$ ) has been assigned based on the available effective power of the WAPS, as defined MEPC.1/Circ.896 (refer to the regulatory gaps identified in section 3.1.2 for EEDI purposes). The reward factor will range from 0.95 to 0.99 depending on the available effective power of the WAPS and the propulsion power of the vessel. The final GHG intensity will be calculated by multiplying the GHG intensity by  $f_{wind}$ . This means that by installing a WAPS, the GHG intensity can be reduced by up to 5%. It is noted that for the derivation of  $f_{wind}$ , FuelEU does not take into account whether the vessel actually uses the WAPS, nor how much the fuel actual savings are.

It is observed that depending on the fuel mix and the applicable  $f_{wind}$  for a specific vessel, installing a WAPS could turn the compliance balance from negative to positive. At the same time, WAPS's operation is expected to reduce the fuel consumption, meaning that a potential negative compliance balance can be reduced, reducing the monetary penalty.

## **EU ETS**

Another important part of the 'Fit-for-55' package is the extension of the scope of the EU Emissions Trading System (EU ETS) under the Directive 2023/959, which was established by the Directive 2003/87/EC of the European Parliament, to maritime transport. This system has two principles, setting a ceiling on the yearly maximum amount of GHG emissions and the trading of EU emission allowances, aiming to contribute to the

wider EU goal to eliminate at least 55% of the continent's net GHG emissions by 2030, compared to 1990. From 2025, shipping companies will have to surrender sufficient EU emission allowances based on EU Monitoring, Reporting and Verification (MRV) data of the previous year. If the allowances prove insufficient, additional allowances can be acquired or a reduction of the carbon emissions will be needed. For each tonne of CO<sub>2</sub> equivalent that has been emitted without surrendering allowances, shipping companies will have to pay a €100 penalty.

To ensure a smooth transition of the shipping industry into the EU ETS scheme, shipping companies will have to surrender allowances for 40% of the verified emissions in 2024 and 70% in 2025. From 2026 and onwards, 100% of the verified emissions will be considered.

Since shipping companies will be paying for the CO<sub>2</sub> they emit, this system can stimulate lower emissions; it will be up to them to determine the method by which that is achieved. As WAPS could contribute to using less fuel, this technology is expected to support ships' compliance with the requirements of FuelEU maritime and EU ETS.

Finally, in April 2022, the EESF's Ship Energy Efficiency sub-group initiated a workstream on wind propulsion, looking at methodologies for performance assessment and potential regulatory barriers.

## **RED II**

The second phase of the Renewable Energy Directive (RED II) is an EU instrument that aims to promote the use of energy from renewable sources. The RED II sets a target for all modes of transport to use at least 32% renewable energy by 2030. It includes a specific 'RES-T' target of at least 14% renewable energy in the final energy consumption (level of energy consumed after losses) from transport by 2030.

The renewable energies in transport could consist of biofuels, renewable fuels of non-biological origin (RFNBO, such as hydrogen and ammonia) and could also include recycled carbon fuels. At all times, the sustainability requirements should be met. With respect to renewable fuels in maritime shipping, the RED II allows member states to apply those fuels towards their RES-T target.

The RED II's impact assessment identified an additional challenge specific to the maritime sector: the juxtaposition of the shipowners' and operators' incentives does not work to stimulate the deployment of renewable fuels.

In response, and to introduce incentives for the maritime and aviation sectors, fuels supplied to either are measured at 1.2 times their energy content (except for fuels produced from food and feed crops) when demonstrating compliance with the renewable-energy target. This provision is meant to boost the uptake of renewable energy in these transport modes.

The 20% extra counting has implications for fuel volumes. As lower fuel volumes will be required to meet the target, the amount by which GHG emissions are reduced may be adversely impacted.

### *Type of renewable fuels within the RED II*

The original RED required member states to oblige fuel suppliers within their jurisdiction to supply a minimum share of renewable energy to the transport sector and to design their supply policies accordingly.

Although the RED only plays a limited role in increasing the share of renewable fuels in shipping, it remains relevant to the maritime sector, given its mature sustainability framework; lessons learned from using biofuels (both liquid and gaseous) in the road-transport sector can help to shape a sustainability framework for their use in shipping.

For sustainability reasons, the growth in the RED should come from advanced biofuels and RFNBO. A dedicated act, which was expected to be published by the end of 2021, should set out the requirements for the renewable electricity used to produce renewable hydrogen and its derivative fuels.

### ***Revision of the REDII: the REDIII***

Because of the higher ambitions of the European Green Deal for reducing net GHG emissions by at least 55% by 2030, the RED II is already being revised before many member states have fully transposed it into national legislation. The 'Fit for 55' package contains a proposal for the revised directive, referred to as the Renewable Energy Directive III.

To achieve the 2030 target, on October 2023, the Council, among other targets, approved an increase of the overall target for renewables in the EU energy mix from the current 32% to 42.5%. An additional indicative top up of 2.5% has also been agreed, which will lead to 45%.

This will be complemented by indicative national targets that show what each member state should contribute to secure the collective target.

The directive aims for large-scale renewables-based electrification. In transport and industry, market segments that are harder to electrify, renewable fuels also should play a major role.

It is noted that wind propulsion has not been included in the list of renewable energy and power sources under RED.

### **Energy Taxation Directive (ETD)**

Taxation initiatives at the EU and member-state level help industries to reach the climate-policy goals by encouraging a switch to cleaner energy. The EU's ETD entered into force in 2003, offering structural rules and minimum rates for excise duties to tax the energy products that are used in motor and heating fuels, and for electricity.

Individual member states are free to set their own rates provided the directive's minimum rates are respected.

Until now, some sectors, such as aviation and maritime transport, have been fully exempt from energy taxation in the EU. However, a revision of the ETD was proposed in the EU's 'Fit-for-55' package; it introduces a new structure of tax rates based on the energy content and the environmental performance of fuels and electricity. This will help the system to ensure that the most polluting fuels are taxed at the highest rate.

The revision also broadens the taxable base by including more products into the scope and removing some of the current exemptions and reductions (EC, 2020).

The above framework implies savings for vessels with WAPS based on realised gains, since less fuel will be consumed.

## **3.5 Gap Analysis**

The uncertainties or lack of specific guidelines to consider WAPS in vessel designs and operations prevent adoption of the technology. Table 25 below summarises the gaps that need to be closed.

Table 24. Gap Analysis Legend.

No gap or changes needed to address wind-assisted propulsion
Small gaps or minor changes to address wind-assisted propulsion



Medium gaps or some challenging changes required to address wind-assisted propulsion

Large gaps or many challenging changes required to address wind-assisted propulsion

Table 25. Synopsis on Regulatory Gap Analysis for Wind-Assisted Propulsion.

Subject	Code	Comment on Code/Standard - Gaps
EEDI	IMO MARPOL Annex VI	<ul style="list-style-type: none"> <li>- Regulation 22/23 of MARPOL Annex VI requires that the attained EEDI/EEXI shall be calculated.</li> <li>- Regulation 24/25 of MARPOL Annex VI provides EEDI/EEXI requirements.</li> <li>- Hybrid definition is unclear</li> </ul>
	The IMO 2022 guidelines on the method of calculation of the attained EEDI for new ships, Resolution MEPC.364(79)	<ul style="list-style-type: none"> <li>- Focus on the method of calculating the attained EEDI.</li> </ul>
	The IMO 2021 Guidance on Treatment of Innovative Energy Efficiency Technologies for Calculation and Verification of the Attained EEDI and EEXI, Resolution MEPC.1/Circ 896	<ul style="list-style-type: none"> <li>- Focuses on the method of treating innovative energy-efficiency technologies for calculation and verification of the attained EEDI/EEXI.</li> <li>- The guidance needs to be improved in several aspects to better assess the contribution of WAPS to EEDI/EEXI, such as the determination of wind-force matrix, the use of wind-probability matrix and the methods of verifying sea trials.</li> </ul>
	The IMO 2022 Guidelines on Survey and Certification of the EEDI, Resolution MEPC.365(79)	<ul style="list-style-type: none"> <li>- Focus on the survey and verification of EEDI.</li> <li>- Do not consider the impact of WAPS on the verification procedure.</li> </ul>
	Ships and marine technology — Guidelines for the assessment of speed and power performance by analysis of speed-trial data, ISO 15016:2015	<ul style="list-style-type: none"> <li>- Focus on the procedures to be applied in the preparation, execution, analysis and reporting of speed trials for ships.</li> <li>- It is difficult to use the procedure to evaluate the performance of ships with WAPS during sea trials.</li> <li>- A standardised methodology needs to be for full-scale evaluation of ships with WAPS based on ISO standards.</li> </ul>
Regulations for EU Member States	Fuel EU Maritime	<ul style="list-style-type: none"> <li>- Focus on increasing the demand for renewable and low-carbon fuels for ships sailing to and from EU ports.</li> <li>- Focus is on well-to-wake emissions.</li> <li>- Credits are given for WAPS, based on EEDI methodology</li> </ul>
	EU Emissions Trading System (ETS)	<ul style="list-style-type: none"> <li>- Sets a limit on the yearly maximum of GHG emissions and the trading of EU emission allowances.</li> <li>- Only focused on tank-to-wake emissions</li> <li>- WAPS is considered implicitly resulting in lower fuel consumption.</li> </ul>
	EU Energy Taxation Directive	<ul style="list-style-type: none"> <li>- Maritime sector has been fully exempted so far.</li> <li>- Revised proposal in which maritime sector is included.</li> <li>- WAPS is considered implicitly due to lower fuel consumption.</li> <li>- Member states independently implement national policy.</li> </ul>
	EU RED	<ul style="list-style-type: none"> <li>- Divided incentives for shipowners and operators do not stimulate the deployment of renewable sources.</li> <li>- Wind propulsion has not been included in the list of renewable energy and power sources under RED.</li> <li>- Member states independently implement national policy.</li> </ul>
Stability	IMO International Code on Intact Stability, Resolution MSC.267(85)	<ul style="list-style-type: none"> <li>- Provides requirements of intact stability for several types of ships and marine vehicles.</li> <li>- Does not consider the impact of WAPS on the stability requirements.</li> <li>- The criteria in the Code may not work for ships with WAPS.</li> </ul>
	Interim Guidelines on the Second Generation Intact Stability Criteria (MSC.1-Circ.1627).	<ul style="list-style-type: none"> <li>- The criteria in the report may not work for ships with WAPS.</li> </ul>

Subject	Code	Comment on Code/Standard - Gaps
	IMO SOLAS II-1	<ul style="list-style-type: none"> <li>- Provides requirements of intact stability and damage stability for passenger ships and cargo ships.</li> <li>- The criteria in the Code may not work for ships with WAPS.</li> </ul>
	IMO Resolution MSC.429 (98)	<ul style="list-style-type: none"> <li>- Provides interpretation to SOLAS Chapter II-1.</li> </ul>
Manoeuvrability and course keeping	IMO Standards for Ship Manoeuvrability, Resolution MSC 137 (76)	<ul style="list-style-type: none"> <li>- Focuses on ships with conventional propulsion systems and does not consider the impact of WAPS on ship manoeuvrability and course-keeping.</li> </ul>
MPP	IMO Guidelines for determining minimum propulsion power to maintain the manoeuvrability of ships in adverse conditions, Resolution MEPC Circ.850	<ul style="list-style-type: none"> <li>- Focuses on the method to determine the MPP for maintaining the manoeuvrability of tankers, bulk carrier and combination carriers in adverse conditions.</li> <li>- It would be beneficial to develop a uniform methodology to calculate the EEDI and MPP.</li> </ul>
Bridge visibility and safety of navigation	IMO Revised Performance Standards, Resolution MSC.192(79)	<ul style="list-style-type: none"> <li>- Provide requirements of radar equipment.</li> <li>- Does not consider the impact of large sail areas which may cause 'radar blind' sectors.</li> <li>- It is recommended to develop specific guidelines to use alternative methods and address the larger blind sectors caused by the WAPS to radar.</li> </ul>
	IMO SOLAS V	<ul style="list-style-type: none"> <li>- Regulation 19/2.7 provides requirements regarding radar systems and blind sectors.</li> <li>- Reg 22 provides detailed requirements for navigation bridge visibility.</li> <li>- Regulation 22/3 leaves special consideration open for "unconventional design."</li> <li>- Does not consider the impact of large sail areas which may cause larger blind sectors than required.</li> <li>- It is to be demonstrated that the vessel with a WAPS satisfies the requirements under SOLAS Chapter V.</li> <li>- Where compliance is impractical, alternatives will be considered on a case-by-case basis in association with the Flag Administration.</li> <li>- It is recommended to develop specific guidelines for using alternative methods to address the larger blind sectors caused by the WAPS.</li> </ul>
	IMO Guidelines for the Installation of Shipborne Radar Equipment, SN1/Circ.271	<ul style="list-style-type: none"> <li>- Some types of WAPS which have a large sail area may affect the ships' ability to meet the requirements in guidelines.</li> </ul>
	IMO Convention on the International Regulations for Preventing Collisions at Sea 1972 (COLREG 72)	<ul style="list-style-type: none"> <li>- Provides detailed specification for the types and locations of the navigational lights that are required to be installed on the vessel.</li> <li>- It is recommended to develop specific guidelines for using alternative methods to address the larger blind spots caused by the WAPS to navigation lights.</li> </ul>
Structure	IACS Classification Societies Rules	<ul style="list-style-type: none"> <li>- It is recommended to develop a comprehensive guideline to provide customised requirements for load determination of different types of WAPS.</li> </ul>
Materials	IACS Classification Societies Rules	<ul style="list-style-type: none"> <li>- It is recommended to include the certification of the materials for various types of WAPS.</li> </ul>
Mooring equipment	IACS Classification Societies Rules	<ul style="list-style-type: none"> <li>- No significant gaps for application to ships with WAPS.</li> </ul>
Electrical systems, machinery, control systems	IACS Classification Societies Rules	<ul style="list-style-type: none"> <li>- No significant gaps for application to ships with WAPS.</li> </ul>
Fire safety and installations in hazardous areas	IACS Classification Societies Rules	<ul style="list-style-type: none"> <li>- No significant gaps for application to ships with WAPS.</li> </ul>
	SOLAS II-2	<ul style="list-style-type: none"> <li>- No significant gaps for application to ships with WAPS.</li> </ul>

Subject	Code	Comment on Code/Standard - Gaps
Crew safety	IACS Classification Societies Rules	- No significant gaps for application to ships with WAPS.
Lightning protection	IACS Classification Societies Rules	- No significant gaps for application to ships with WAPS.
Survey, testing and certification	IACS Classification Societies Rules	- It is recommended to develop standardised testing procedures for structure integrity and performance assessment of the WAPS.
Helicopter safety	CAP 437 Standards for offshore helicopter landing areas	- It is recommended to assess the impact of WAPS on the helicopter-landing areas.

### 3.6 Marine regulation conclusions

The installation and operation of WAPS introduces additional considerations for the safety and performance of the vessel. Many regulations, standards and guidelines do not consider the impact of WAPSs, and this imposes a barrier to their adoption. The specific impact of WAPS on ship manoeuvrability, stability, EEDI performance, MPP and helicopter-landing areas needs to be assessed. Present regulations, standards and guidelines need to be updated to consider the impact of WAPS and facilitate their adoption.

Specifically, these are the near-term actions and regulatory gaps that need to be addressed:

- Derive a practical methodology for assessing the contribution of WAPS to the EEDI/EEXI and make correspondent updates to regulation MEPC.1/Circ. 896.
- Develop a standardised methodology for full-scale evaluation and verification of EEDI/EEXI for ships installed with WAPS.
- Develop specific guidelines for the navigation safety of ships with WAPS that allow alternative methods to be used to compensate the larger blind spots that are caused.
- Investigate if the present criteria in the IMO Code on Intact Stability and IMO's second generation of stability criteria should be adapted to ships with WAPS.
- Investigate if damage stability criteria for all ships should be adapted to ships with WAPS.
- Investigate if the present criteria in the IMO Standards for Ship Manoeuvrability are applicable to ships with WAPS.
- Develop a uniform for MPP.
- Resolve the categorisation of WAPS under non-conventional or hybrid propulsion and associated implications.
- Derive customised requirements to determine the loads of the different types of WAPS.
- Include the certification of the materials for various types of WAPS in the class rules.
- It should be evaluated whether Class Societies need to create a UR to cover some key aspects for WAPS, including loads, materials, electrical systems, crew safety, lightning protection, survey and testing, etc.
- The impact of WAPS on helicopter-landing areas needs to be assessed.

## 4. Risk assessment using Wind- Assisted Propulsion as Marine Fuel in Merchant ships

The safety regulations for the use of wind-assisted propulsion still need to be developed, as described in the Section 3. As part of this study, a HAZID assessment was carried out for generic ship types to contribute to discussions regarding safety and risk management for WAPS. This part of the study provides an analysis of key aspects of WAPS safety in various types of marine vessels. Three types of marine vessels were considered in this study.

- A Ro-Pax Ferry using Rotor Sails
- A General Cargo vessel using VentoFoil<sup>®</sup> (Suction Wings)
- Wind Propelled H<sub>2</sub> Assisted Container Carrier

The purpose of this study is to identify the potential major hazards relative to the operational configuration of the proposed vessel with WAPS at an early stage of its concept development, review the effectiveness of selected safety measures and, where required, expand the safety measures to achieve tolerable levels of residual risk.

Early identification and assessment of hazards provides essential input for concept development at a time when a change in the design has a minimal internal cost. In the context of this study, the outcomes will help the European Maritime Safety Agency (EMSA) to draft recommendations to develop and adapt current procedures and regulations.

In that context, HAZID workshops were undertaken to evaluate and summarise key aspects of safety as it pertained to the installation of WAPS onboard vessels. These HAZIDs included participation from an ABS multi-disciplinary team, shipowners and vendors.

### 4.1 WAPS Safety

A WAPS is typically a mechanical and electrical system. The main safety issues that arise from installing WAPS on seagoing ships are:

- Vessel stability
- Excessive heel
- Manoeuvrability
- Operational obstructions, including cargo handling
- Navigational aspects
  - Obstruction to visibility
  - Radar blind spots
  - Navigation lighting
- Mooring and anchoring equipment number
- Fire and lightning protection
- Installation in 'hazardous areas'
- Harmonics impact due to electrical motors
- Cold weather - icing
- Foundation and structural integration
- Potential for dropped objects
- Reliability and availability
- Software and control

### 4.2 HAZID Objectives, Process, Scope and Assumptions

This section explains the common objectives, methods and scope, etc., for all vessel types in this study.

### 4.2.1 Objectives

The HAZID study is to identify the ‘high-level’ risks associated with operating WAPS on various types of ships (e.g., Ro-Pax, Bulk Carriers, Container ship etc.). The study focus is to identify risks to WAPS from external hazards onboard the vessel, risks to the vessel from the WAPS itself, risks to personnel and environment due to internal and external hazards related to operating WAPS.

The study objectives are:

- Identify potential hazards introduced by the installation and operation of WAPS.
- Determine potential consequences of the hazards.
- Identify safeguards to effectively prevent, control and/or mitigate the hazards.
- Propose recommendations, as needed, to eliminate, prevent, control or mitigate hazards.

The outcomes of the study are documented in a HAZID register, which includes:

- Potential hazardous scenarios, including causes, consequences and present safeguards.
- The risk of each scenario with respect to the severity and likelihood of the consequences.
- Opportunities for an inherently safer design or risk-mitigation measures to reduce the estimated risk.

### 4.2.2 Common Scope

It is assumed that all vessel types are in full compliance with regulatory and classification requirements; the scope looks at almost all aspects of the vessels, with specific focus on the systems’ integration into the vessel.

The HAZID studies covered:

- General arrangement of the vessels
  - Location of the WAPS
  - Stability
  - Structural interfaces and loads
- Propulsion systems
- System interfaces
- Electrical and Hydraulic systems
- Vessel Operational Modes
- Hazards in ports & SIMOPS
- Cargo Operations
- Cold weather operations
- Maintenance and Inspection
- Installation hazards
- Materials, Manufacturing
- Escape, evacuation and rescue

### 4.2.3 HAZID Workshop Methodology

A HAZID assessment is an extremely useful tool for performing high-level risk assessments of specific systems. ABS has used this approach in numerous risk-assessment projects, as a standalone analysis and to compare similar situations.

The HAZID workshops were held via videoconference. After each workshop, a brief review was conducted with the participants. A flow diagram for the overall HAZID process is shown in Figure 17 below.

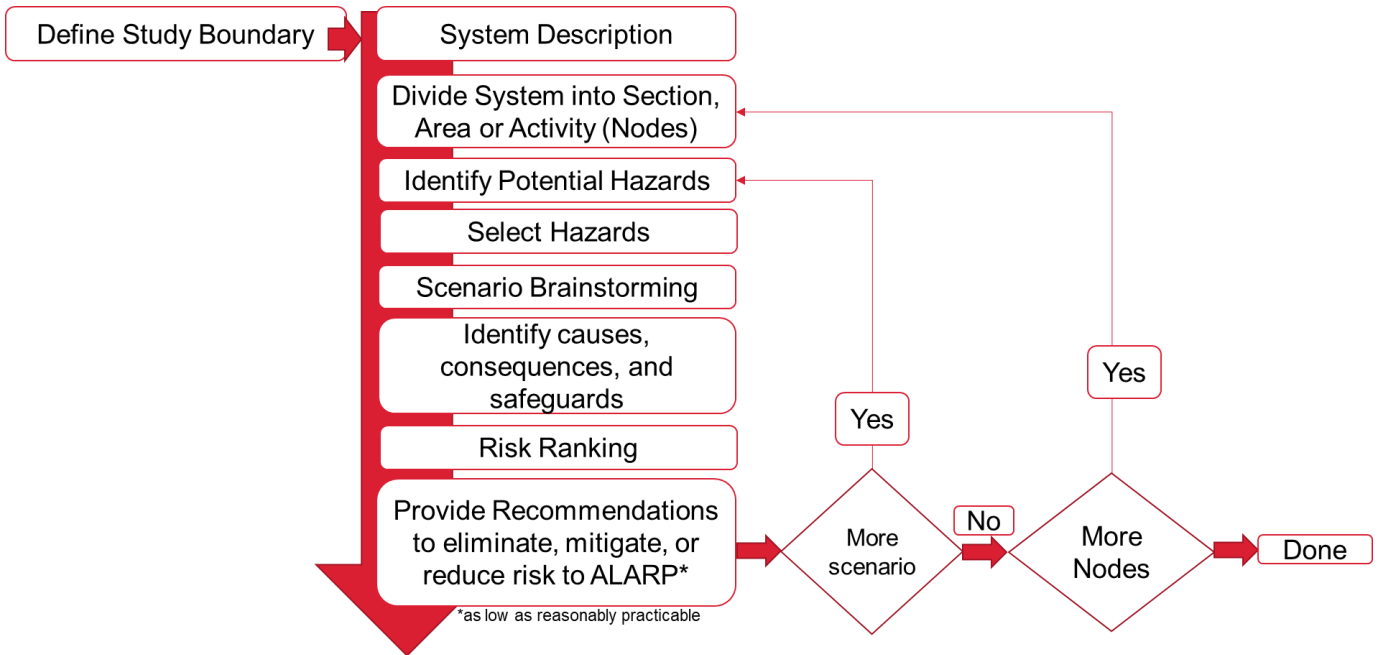

Figure 17. HAZID Process.

During the workshops, a ‘facilitator’ guided subject-matter experts through a structured discussion to identify and risk-rank the hazards. Participants were asked to provide input on preloaded scenarios (e.g., modifying, adding, or removing risk scenarios) within the hazard register, as well as to discuss the location of the scenario on a risk matrix. These discussions guided the focus areas, nodes and hazards to be considered before the study could be considered complete.

HAZID team members used a workshop environment to identify and analyse the boundaries of the study and to brainstorm the potential ‘what if’ scenarios in each node. For clarity, a ‘node’ is a clearly defined, manageable section or system to be discussed in the brainstorming activity. ‘Guidewords’ are a set of conditions, such as ‘high pressure’ or ‘vessel collision’, that help to streamline brainstorming activity and identify potential hazards. Guidewords and sub-categorisations were used to identify the potential threats and the present controls that could be used to limit or prevent their impact. Where required, recommendations were generated.

The HAZID analysis was conducted in sessions, which individually addressed each arrangement, process and operation on the ships.

#### 4.2.4 Limitations

The risk assessment was limited to a ‘simplified HAZID’ analysis following the methodology described in this section. In most cases, the use of WAPS was at the initial phase of the project, making HAZID the most appropriate way to identify the risks.

The concept was used to provide a baseline to identify WAPS hazards and risks and to develop recommendations. Design variations, such as the onboard location of the WAPS, were considered for the baselines, but how those variations increased or lowered the general risk environment relative to the base case was not examined.

The workshop team identified several significant hazards related to the nodes for the systems analysed. There may be other hazards that are not included, so further safety assessments should be conducted for each vessel; these assessments could be greatly impacted by the general arrangement and type of each asset.

#### **Limitations of the Rotor Sail Concept**

A Ro-Pax vessel has been considered with a fixed installation of a Rotor Sail in midship centerline. The electrical drive motor of each Rotor Sail is connected to the electric grid of the vessel (no other drive mechanism has been considered). Risks related to software and control systems were only considered from the perspective of

a major function failure. Functionality and its accuracy were not considered. Also, the amount of fuel savings was not part of the risk assessment, nor was the prospect of multiple-systems installation.

### **Limitations of the VentoFoil concept**

A General Cargo vessel was considered with two VentoFoil installations at the fore of the ship, one on the starboard side and the other on the port side. Other potential configurations -- such as between cargo holds, solely on one side of the vessel or at the aft of the vessel -- were discussed, but not analysed in detail. The major risks entailed with folded/tilted systems have been briefly discussed during the HAZID workshop, but the risk of such system was not analysed in detail.

Software and control-system related risks were analysed from major-failure perspective. Functionality and its accuracy were not considered, nor was the potential for fuel savings.

The WAPS contribution in the Rotor Sail and VentoFoil cases examined was rather limited and the case of greater wind-assist contribution was not analysed. It is, however, noted that since most WAPSs do not have a direct connection with engine control, in such cases the thrust produced may result in the vessel design speed being exceeded. Such scenarios should be analysed as the ship and her equipment may be outside their safe design envelope.

### **Limitations of the Sail concept**

This sail concept design is such that in favourable wind conditions the ship does not need additional propulsion power. However, electrical power is still needed to run ship and accommodation systems, therefore an additional power source is required for sail operation, lightning, navigation, manoeuvring, emergency power, accommodation needs etc.

The sail concept also needs back-up propulsion to assist sail in case of no wind or unfavourable weather conditions. Typically, one voyage reserve propulsion capability is needed to ensure a safe voyage and safety of crew.

In cold weather where icing is expected, issues may arise due to icing, so this requires further analysis.

Today's mariners are not trained to operate such vessels and detailed training programs need to be developed for the sail concept.

## **4.2.5 Risk Ranking**

A risk matrix (found in Appendix III – HAZID Risk Matrix) was used for a high-level evaluation of the risks from each hazardous scenario and their impact on personnel injury and disease, asset, environment and reputation. In selected cases where a scenario had multiple impacts, such as 'environmental' and 'personnel injury', the study will document the 'overall' impact. The process used to rank the risks included a:

- **Consequence review:** To identify the most credible worst outcome for each scenario; the team determined the outcome's location on the consequence axis.
- **Likelihood review:** The team determined the location of the undesired outcome along the frequency axis, considering the probability of failure for the preventive, detection and recovery safeguards designed to ensure mitigation.
- **Risk:** The intersection of the likelihood and consequence ratings produces the risk level for that specific hazard scenario.
- **Action:** The risk ranking was used to help assess whether the current controls and safeguards are adequate; if not, additional safeguards/controls were identified to that could reduce the risk (or identify areas where further review or analysis would be required to better understand the risk and mitigation measures) and documented as 'actions' to be taken.



#### 4.2.5.1 Grouping Systems/Areas for HAZID

Drawings for each vessel HAZID were reviewed, while recognising that some of the designs were at the development stage and not all information was not available. To derive the maximum benefit, it was decided that the focus would be mostly on the WAPS and how they might affect safety during the operation of the vessels. The following were considered (where applicable):

- Vessel General Arrangement
- Wind-Assisted Propulsion System & System Operational Mode
- System Interfaces
- Control/Automation System
- Utilities system
- Vessel Operational Mode
- Installation Hazards
- Hazards in Port & SIMOPs
- Cargo Operation
- Cold-weather operation
- Maintenance and Inspection
- Materials
- Manufacturing
- Hydraulic system
- Electrical system

#### 4.2.5.2 Modes of Operation

All operational modes were considered in relation to the vessel and WAPS. In general, the vessel-related operational modes considered included: sailing, sailing through a storm, high wind, entry into a port/restricted area, departing from port, passing through channels and SIMOPS in port (e.g., cargo operations). WAPS-related operational modes specific to each system were considered.

For the VentoFoil system two function modes (up and down) were also considered.

### 4.2.6 Hazards

#### 4.2.6.1 General WAPS Related Hazards

Some of the hazards that were considered during the assessment and regarding the WAPS included:

- Loss of power
- Vessel Grounding, Collision and Allision
- Adverse weather impact
  - Cold-weather impact i.e., icing
  - High wind
  - High waves
- Lightning strike
- Noise and Vibration issues due to high rotation speeds
- Dropped object/dropped potential.
- Cargo operation
- Harmonics
- Sensors and control system failures
- Control system failures
- Failures connected with the hydraulic system
- Dissimilar materials
- Fire
- Failures connected to the automation systems.
- Operator working at height during inspection and maintenance
- System and component failures

#### 4.2.6.1.1 System Hazards

The following systems hazards are considered:

- Simultaneous Operations (SIMOPS)
  - Cargo operations: loading/unloading, supply, etc.
- Interface Issues
  - Process, instrumentation, utilities, structural, etc.
- Emergency Response
  - Access/egress, communication (alarms [audible/visual], call-points, CCTV, radio), fixed/portable fire-fighting equipment
- Any Other Hazards
  - Lifting operations, structural failure, rotating machinery, cold/hot surfaces, etc.

Any other 'issues of concern' or items requiring coverage

#### 4.2.6.1.2 Ship-Applicable Hazards

Where applicable, the following hazards were considered:

- Global Hazards (\*):
  - Natural and Environmental Hazards -- Climatic extremes, lightning, seismic events, erosion, subsidence, etc.
  - Movement/Floatation Hazards -- Grounding, collision
  - Effect of Facility on Surroundings -- Proximity to adjacent installations, proximity to transport, proximity to population, etc.
  - Effect of Man-made Hazards -- Security hazards, social/political unrest, etc.
  - Infrastructure -- Communications, supply support, mutual aid, emergency services, etc.
  - Environmental Damage -- Discharges to air/water, emergency discharges, water disposal, etc.
  - Health Hazards – Disease, Carcinogens, Toxic effects, Occupational hazards

#### 4.2.6.2 Common Failure Causes

##### 4.2.6.2.1 Equipment Failure Causes

- Wear and tear
- Erosion
- Stress and Strain
- Fatigue
- Corrosion
- Collision
- Grounding
- Impact
- Fire

##### 4.2.6.2.2 Process Control Failures – operating outside of design

- Temperature high/low
- Pressure high/low
- Flow: high/low/reversed/no flow
- Level high/low
- Loss of power
- Electrocutation
- High/low current

#### 4.2.7 General Assumptions – Applicable to all HAZID studies

There were several critical assumptions made for the workshops, based on current documentation; some were deemed of such importance to be considered ‘assumptions’ rather than ‘recommendations’. Most were considered ‘safeguards’ in the workshop records. The most common critical assumptions are listed below. Any assumption specifically applicable to a particular vessel type was listed within its HAZID section.

- The vessel will be designed and built in compliance with class and statutory regulations.
- WAPS will be not functional during cargo operations.
- Structural integration of WAPS within the ship will be designed and tested according to classification society rules.
- Materials will comply with classification society rules.
- Electrical equipment will meet the appropriate requirements if installed in hazardous area.
- Software for WAPS control will be functionally tested and certified by the vendor.

#### 4.3 HAZID Results – Findings and Recommendations

All high-level risks were considered and the safeguards required by codes/standards/regulation were identified; the risk rankings were developed and listed in the risk register’s appendices for the three vessel types. As a WAPS has a great impact on stability, structure, visibility etc., many risks and safeguards were identified. As regulations are not yet available to cover WAPS specific aspects, and while several class societies are publishing requirements for classification, many of the study’s recommendations called for further analysis.

However, all recommendations were listed for consideration and may help to inform new prescriptive requirements and to develop safer designs and arrangements. The recommendations are listed for each vessel in the appendix:

- Appendix IV – List of Recommendations – Ro-Pax Ferry vessel using Rotor Sails
- Appendix VI – List of Recommendations General Cargo vessel using VentoFoil© (Suction Wings)
- Appendix VIII – List of Recommendations Wind Propelled H<sub>2</sub> Assisted Container Carrier

A high-level summary of important recommendations which require further study and research, regarding WAPS as applicable, is listed below. It is noted that the recommendations listed below may not be applicable to all WAPS.

- For a WAPS with a rotating unit, the static vs rotating heeling moment needs to be considered for vessel stability. Currently, there are only regulations for static stability and there is no regulation to consider the rotating heeling moment. Regulations are to be developed for this technology.
- WAPS may impact vessel’s manoeuvrability and more study is needed to understand the impact and to identify the effective operational/design mitigation for implementation.
- Vessel’s stability with WAPS to be further analysed in high wind conditions.
- If a vessel operates in a climate with potential for ice accumulation, the potential for accumulation on the WAPS system and its impact needs to be investigated (e.g., impact on stability or ice built-up impacting functionality of WAPS system, ice loading, ice falling on vessel’s equipment and human).
- Motions higher than the vessels’s design limits may lead to performance issues, damage and vibrations in the WAPS. Vessel-operating parameters that consider WAPS’ design and the functions of its control system need to be developed.
- A vibration study and analysis needs to be conducted to understand the vibration ranges that may impact the components and structure of the WAPS. Noise and vibration analysis is to be considered for passengers and crew comfort and safety.
- The impact of green water on the structure and system of WAPS are to be evaluated and the appropriate preventive measures provided.
- Evaluate the vessel’s water-drainage capabilities on deck in case there is a fire in the WAPS, and the fire water system needs to be activated to extinguish it.

- Conduct an analysis of the fire risks and evaluate fire-mitigation measures for each vessel installation, including its components and interfaces with the vessel's systems, such as control systems, fire detection and suppression.
- Investigate the current fire-suppression system to verify that, in the event of a fire on the top of the WAPS (e.g., 30 m high), the fire water system has enough pressure and hose length to reach the fire.
- Lightning protection for WAPS should be studied.
- As a WAPS is a potential obstacle to navigation, the following issues need to be further investigated:
  - Obstruction to visibility from pilot house
  - Radar blind spots
  - Obstruction to Navigation lighting
- To be checked whether WAPS installation will affect the Equipment Number (EN). For folded/tilted systems, the impact on mooring and anchoring equipment should be further investigated, when in doubt.
- Ensure that the information on the wheelhouse is updated to account for the changes in air draft.
- Evaluate the WAPS design for drop-object potential (loose equipment, vibrations leading to loose bolting etc.) and develop prevention and/or mitigation measures to minimise the impact of drops on the crew and vessel structures.
- Inspection and maintenance procedures need to consider drop potential and the impact on crew safety and structure damage. Consider having drop protection practices in place.
- Develop proper procedures for inspection and maintenance activities and detailed procedures for operator working at height (man aloft). Proper Job Safety Analysis (JSA) and operator training are to be developed.
- Develop vessel procedures and provide appropriate personal protective equipment (PPE) with recommendations from manufacturer on emergency procedures for operator injuries, man overboard scenarios, emergency rescue activities.
- Operation manual/procedure to determine the appropriate weather conditions (including wind speed, vessel motion) for safe working conditions in case of emergency.
- During cargo operation, WAPS in upright position may be a major interference with port equipment. Additional study needs to be conducted and measures should be implemented to protect assets and people.
- The impact of harmonics from variable-frequency electrical motor needs to be considered.
- With WAPS being an active system, its reliability and availability need to be further investigated to realize potential benefits.
- Training program to be developed for crew considering the new technology installed on ship.
- Remote control and main control for the WAPS system are to be investigated further in Failure Mode Effects and Criticality Analysis (FMECA) study and appropriate class requirements and notations are to be considered.
- Interference with mooring system and equipment needs to be further studied when multiple WAPS are installed on deck on forepart of ship.

#### 4.3.1 Ro-Pax using Rotor Sail WAPS System

The proposed Ro-Pax ferry is hybrid powered with the pilot house fwd. The Rotor Sail is installed on the centre line. The Rotor Sail will provide power when the wind is favourable during sailing and will consequently reduce fuel consumption.

The general arrangement for the vessel is provided in Figure 18.

Rotor Sail operates based on Magnus effect principle to generate fwd. thrust in favourable wind condition. The height is approximately 30 metres and diameter is 5 metre. Assembly weight is 42 tonnes excluding foundation in ship structure. Rotor weight is approximately 20 tonnes. Rotor is made of composite material with special coating to minimise icing effect. Internal support structure is made of steel structure. Rotor Sail is design for operation in – 20° C to 50° C temperature range. Rotor Sail rotational speed is 180 rpm. It is controlled by variable frequency drive to maintain desire rotational speed to generate maximum thrust.

Due to height of Rotor Sail vessel air draft been increase by approximately 20 metres from original height.

Main Components of Rotor Sail:

- Upper support main bearing & shaft
- One Direct Drive Electric Motor and drive for rotation
- Lower support rollers
- Foundation on Ship's Deck
- Electric cabinet
- Safety Switch
- Cable rack
- Ladder
- Frequency converter

Rotor Sail uses ship's electricity to rotate a rotor cylinder in the wind. Rotating cylinder can produce maximum 14x physical thrust.

Rotor Sail is controlled by automated control system which runs using proprietary software. Controls are located in the pilot house and there is also a local control provided at the Rotor Sail.

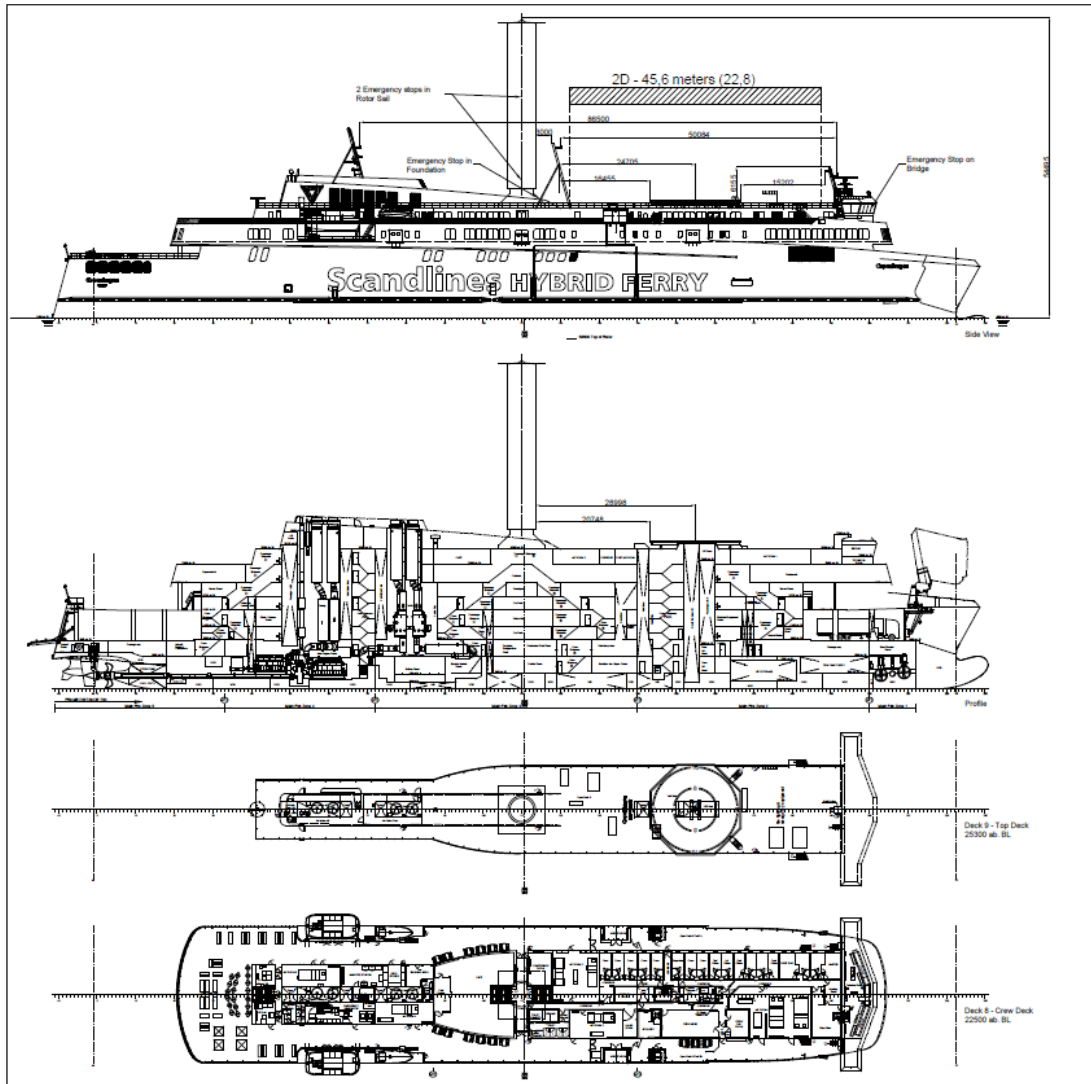

Figure 18. Rotor Sail Ro-Pax General Arrangement.

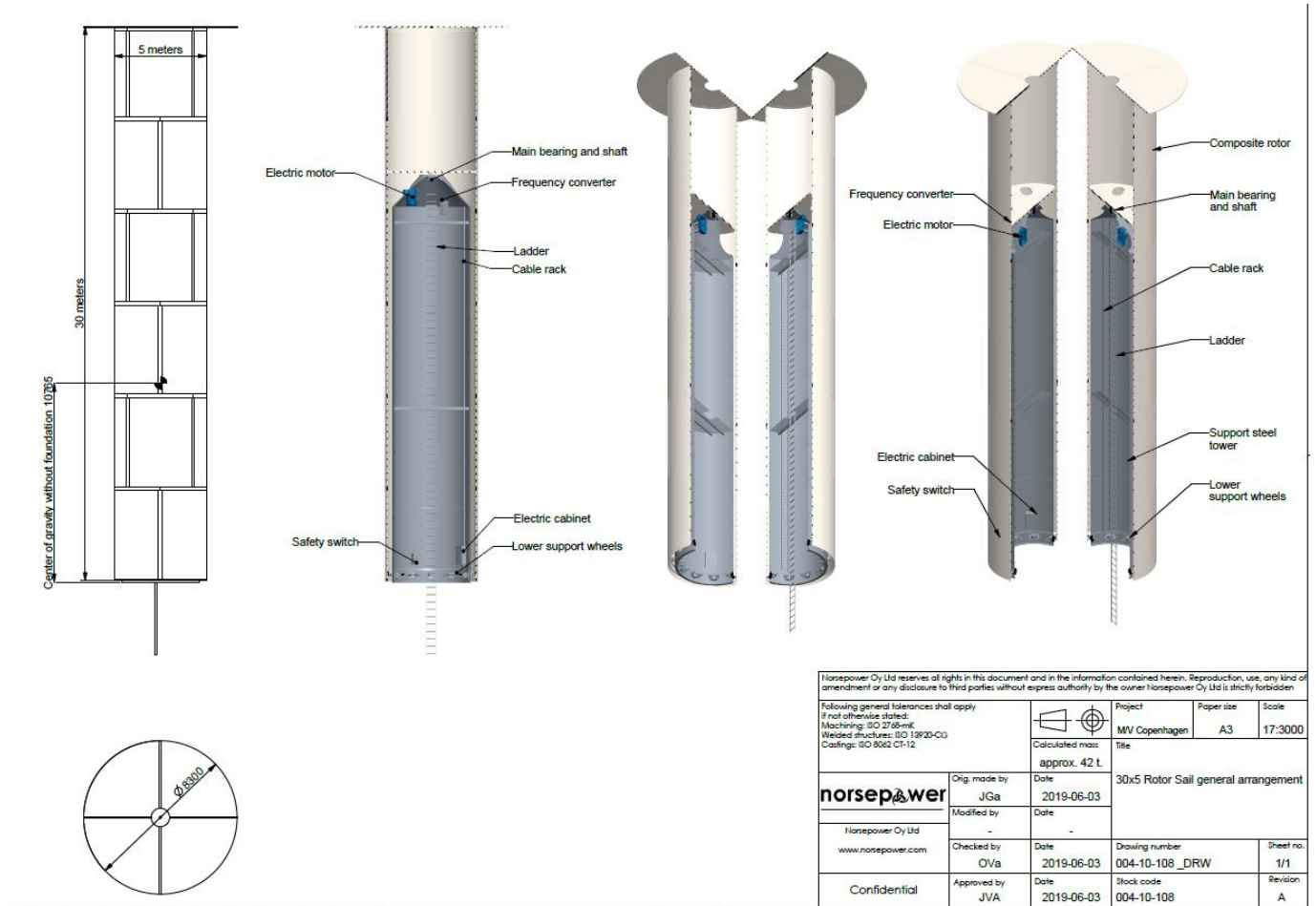

Figure 19. Rotor Sail General Arrangement.

#### 4.3.1.1 Assumptions – Ro-Pax

In addition to the assumptions listed above, other assumptions from the workshop are listed below:

- To avoid bearing damage rotor to be keep running with minimum rpm (3-5 rpm)
- Appropriate drainage will be provided in base.
- Ferry has a second mast with navigation lights to compensate for blind spots.
- Drains in the foundation in case of condensation or water ingress due to green sea state.
- Unique polar diagram is developed for ferry and automation software is adjusted accordingly.
- System and components are design for a 25-year service life. Project specific design life will be determined.

#### 4.3.1.2 Conclusions and Recommendations

The project is at the concept stage and, for the workshop’s recommendations to be feasible, certain conditions were assumed and listed in the assumption section. For some nodes, there was not enough information available. This precluded a risk ranking being attributed to some hazards. However, the activities associated with those scenarios were discussed and, where feasible, recommendations were made.

The results of the HAZID workshop are to be analysed and incorporated into future developments of the concept. A complete list of recommendations and the HAZID register are in Appendix IV – List of Recommendations – & Appendix V – HAZID Register – Ro-Pax Ferry vessel using Rotor Sails. System and



operational level nodes, along with the scenarios associated with each node, were discussed. Where the risk was deemed to be high, recommendations were developed from the scenarios identified during the workshop.

The HAZID register identifies the hazards and documents the recommendations from the workshop’s discussions. Sixteen (16) ‘high’ risk scenarios were identified that will require mitigation as the design progresses. Each of those have recommendations listed in the HAZID register. See the summary in Table 26 below.

Table 26. Ro-Pax Rotor Sail - HAZID Risk Ranking Summary.

Key system level HAZID nodes	Risk Ranking of Hazards Identified			
	Low	Moderate	High	Extreme
Node 1: Vessel General Arrangement				
Node 2: Wind-Assisted Propulsion System (Rotor Sails) & System Operational Modes	26	56	8	
Node 3: System Interfaces	2	2		
Node 4: Rotor Sails Control/Automation System	2	1	1	
Node 5: Utilities System	1	4	1	
Node 6 : Vessel Operational Modes				
Node 7: Installation Hazards			2	
Node 8: Hazards in Port & SIMOPs			2	
Node 8: Maintenance and Inspection	1	5	2	
<b>Total</b>	<b>32</b>	<b>68</b>	<b>16</b>	

There were no unresolvable risks identified during the preliminary HAZID that would prevent further development of the Ro-Pax vessel using Rotor Sail system. Appendix IV – List of Recommendations – Ro-Pax Ferry vessel using Rotor Sails provides a summary of the recommendations from the HAZID register with applicable nodes for the HAZID scenarios.

The key findings and recommendations from the HAZID study and the additional risks that would need to be addressed are summarised below:

- Rotor Sail static vs. rotating heeling moment need to be considered for vessel stability. Currently, there are regulations only for static stability and there is no regulation to consider the rotating heeling moment. Regulations are to be developed for this technology.
- Develop vessel operational parameters considering the Rotor Sail design and control system functions. The issue discussed is higher vessel motion than the design limits may lead to the Rotor Sail performance issues, damage, and vibrations.
- If a vessel operates in a climate with potential for ice accumulation, the potential for ice accumulation on the Rotor Sail system and the impacts to be investigated.
- Vibration study & analysis to be conducted to understand vibration ranges that may impact components and structure of the Rotor Sail for each vessel installation. Also consider the vibration impact on passengers and crew comfort.
- Conduct fire risk analysis and evaluate fire mitigation measures for each vessel installation, considering fire analysis for the Rotor Sail and its components and interfaces with vessel systems such as vessel control, vessel fire detection, and vessel fire suppression system.
- Investigate existing vessel fire suppression system to verify that, in case of fire in the top of the Rotor Sail (30 m high), the vessel fire suppression system has enough pressure and hose length can reach the fire.
- Noise and vibration analysis to be conducted for passengers and crew safety on a passenger vessel.
- Evaluate potential forward visibility issues from the vessel pilot house and radar blind spots if the Rotor Sail is installed onboard a vessel. This is not a significant issue for the Ferry since the pilot house is forward and there are 2 radars in the front and 1 radar aft of the vessel. SOLAS Chapter V Regulation 22 are to be met.
- Check whether the Rotor Sail installation will affect the EN. For the ferry, there is no issue identified with changes in the EN because the equipment is less than B/4 and therefore not taken into account in the calculation.

- Ensure that the information on the wheelhouse is updated to account for the change in air draft.
- Evaluate the Rotor Sail design for drop potentials (loose equipment, vibrations, etc.) and develop prevention and/or mitigation measures to minimise the impact of potential drops on crew and vessel structures.
- Inspection & Maintenance Procedures to consider drop potential and the impact on crew and structure damage. Consider having drop protection practices in place.
- In addition to visual routine inspection to detect delamination issues in the composite material layers of the Rotor Sail, consider active thermography scanner which can show defects in small scale (centimetres) inside the layers.
- Evaluate the water spray nozzle/hydrant pressure considering SOLAS minimum requirements for each vessel type and Rotor Sail installation. For the passenger ship, the minimum pressure at hydrants is 0.4 N/mm<sup>2</sup>.
- Evaluate the firefighting system onboard a vessel with Rotor Sail installation to ensure that there is sufficient coverage (water pressure, flow capacity) to extinguish a fire on top of the Rotor Sail.
- Evaluate the vessel's water drainage capabilities on the deck in case of fire in the Rotor Sail and the fire water system is activated to extinguish the fire. There are drainages in the foundation of the Rotor Sail, however, water drainage from the vessel deck should also be evaluated to avoid vessel stability issues.
- Depending on the vessel location (hot climate), consider the impact to worker comfort and heat injury when conducting maintenance/inspection activities in the Rotor Sail at high temperature, and develop procedures and heat prevention practices (portable fans, water).

#### 4.3.2 General cargo vessel using VentoFoil© (Suction Wings)

It is proposed to install VentoFoil© (Suction Wings) system on small General Cargo vessel. Two VentoFoil units will be installed forward of the ship outside container cargo area on port and starboard side. The system selected is a tilting type of system, where VentoFoil can be laid horizontally on ship either fwd. or aft on its base. VentoFoil will provide additional propulsion power when wind is favourable during sailing and will help save fuel.

The general arrangement for the vessel is provided in Figure 20 and VentoFoil in resting position is shown in Figure 21.

The VentoFoil is designed to generate forward thrust through lift created by wind. The rigid wing sail will rotate/slew into the wind at an angle of attack of about 25 degrees. The powered slewing bearing can rotate within 310 degrees to ensure optimal angle of attack. There is an area between approximately +/- 25 degrees from the bow where the VentoFoil will not create forward thrust (sailing into the wind).

When the VentoFoil is in the correct position, ventilations fans located in the wing sail will be set at an optimal speed according to wind speed via Variable Frequency Drives (VFDs). They will suck wind into the wing sail and create a laminar wind flow along the wing sail, which enable much larger angles of attack (~25°) than a traditional wing (12°). The lift coefficient will be much higher than a traditional sail and still several times higher than a modern rigid wing sail. The frequency-controlled ventilators adjust speed according to the wind speed, and reverse when tacking. They are at maximum revolutions when the wind speed is 14 m/s, which is maintained until 17 m/s (31.5 knots ~Beaufort 7).

The VentoFoil is designed to remain upright in storm and hurricane conditions. Luffing or tilting the VentoFoil down for securing (a), storage (b), drag reduction in headwinds (c) or remove them out-of-the-way for cargo operations (d) is optional. Luffing and tilting of VentoFoil is done by hydraulic cylinder and motors. A HPU with control system, hydraulic reservoir is provided for this operation.

VentoFoil lowering & lifting to either port or starboard side is generally symmetrical. The actual movement might not be simultaneous in practise, since each VentoFoil has its own control and hydraulics. The control screen allows simultaneous raising and lowering, but individual is also possible. The latter is also allowed by local control and emergency control.

The VentoFoil is designed for -20 to 32 °C but sailing in areas with a risk of Ice & Icing requires special consideration. The VentoFoil should not be operated while a pilot is on board and in narrow channels or restricted waters in order to not interfere with the vessel’s manoeuvrability.

Suction wing suction motor and fan is controlled by VFD drive.

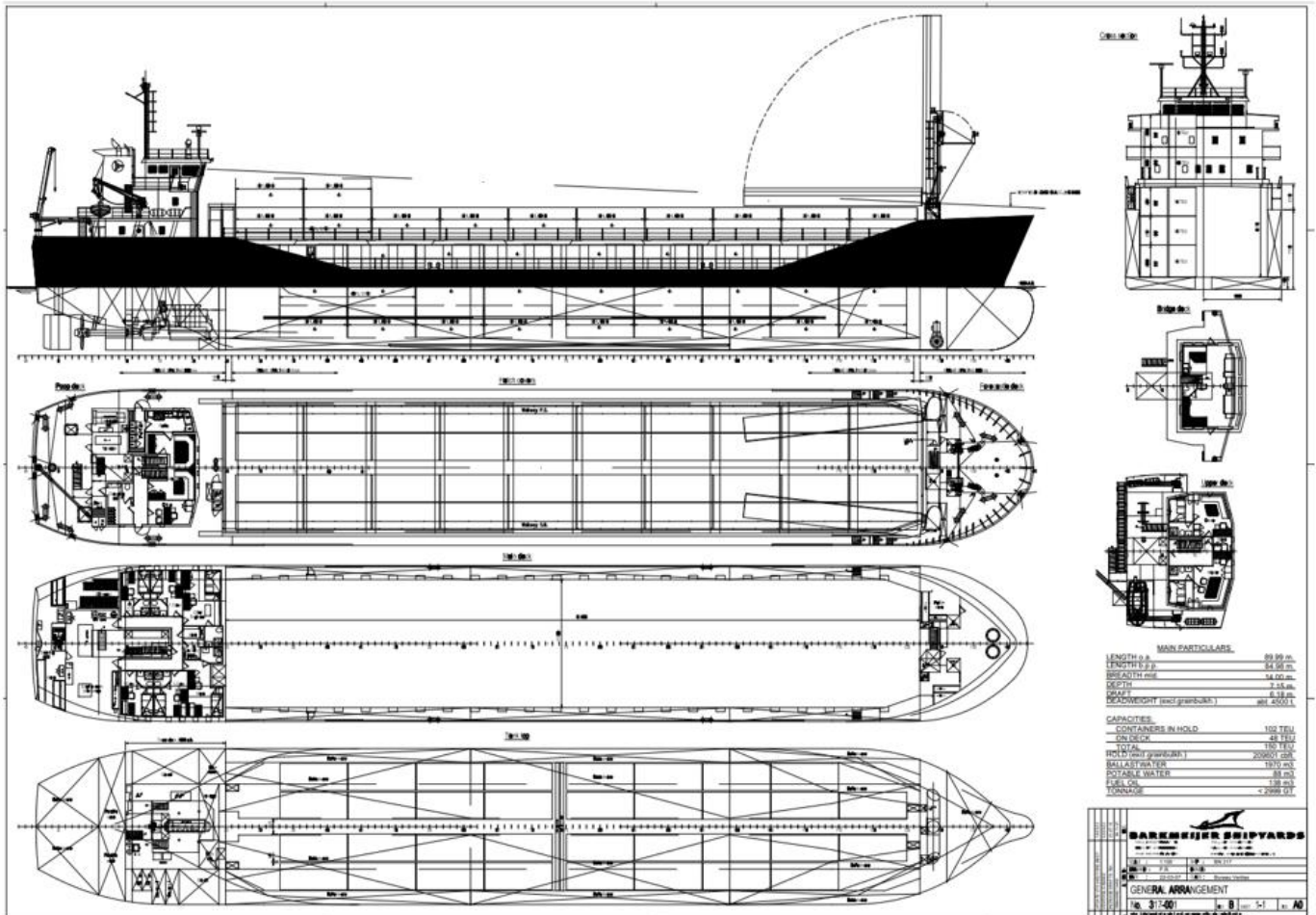

Figure 20. General Arrangement General Cargo vessel using VentoFoil© (Suction Wings).

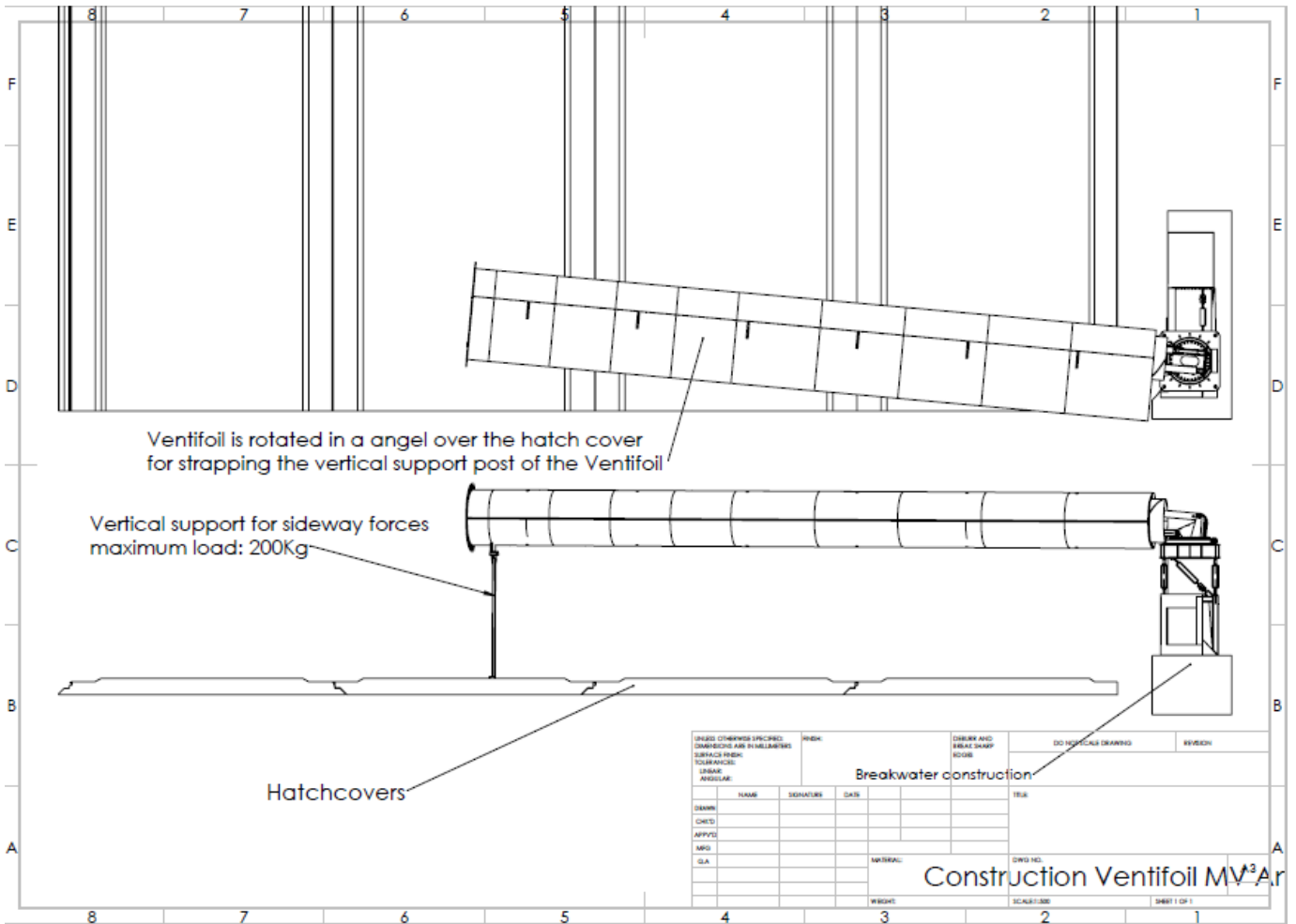

Figure 21. VentoFoil in resting position.

#### 4.3.2.1 Assumptions – General Cargo ship using VentoFoil® (Suction Wings)

In addition to the assumptions listed in above, other assumptions from the workshop are listed below:

- Operation in Ice or low temperature will be of special consideration for this system due to icing issue.
- To avoid obstruction to cargo operation system will be tilted.
- Appropriate support system (like crane rest) will be installed for tilting system.
- Additional navigation mast will be installed fwd. of VentoFoil system.
- In extreme weather condition system can be tilted and supported on rest on deck.

#### 4.3.2.2 Results and Recommendations

The project is at the concept stage and, for the workshop’s recommendations to be feasible, certain conditions were assumed and listed in the assumption section. For some nodes, not enough information was available. This precluded a risk ranking being attributed to some hazards. However, the activities associated with those scenarios were discussed and, where feasible, recommendations were made.

The results of the HAZID workshop are to be analysed and incorporated into future developments of the concept. A complete list of recommendations and the HAZID register are in Appendix IV – List of Recommendations – & Appendix VII – HAZID Register General Cargo vessel using Ventofoil® (Suction Wings). Appendix V – HAZID Register – System and operational level nodes, along with the scenarios associated with each node, were discussed. Where the risk was deemed to be high, recommendations were developed from the scenarios identified during the workshop.

The HAZID register identifies the hazards and documents the recommendations from the workshop's discussions. Sixty-Five (66) 'high' risk scenarios were identified that will require mitigation as the design progresses. Each of those have recommendations listed in the HAZID register. Refer to the summary in Table 27 below.

Table 27. VentoFoil© - HAZID Risk Ranking Summary.

Key system level HAZID nodes	Risk Ranking of Hazards Identified			
	Low	Moderate	High	Extreme
Node 1: Vessel General Arrangement	6	6	29	
Node 2: Wind-Assisted Propulsion System (Rotor Sails) & System Operational Modes		7	2	
Node 3: System Interfaces				
Node 4: Rotor Sails Control/Automation System		4	6	
Node 5: Utilities System				
Node 6 : Vessel Operational Modes	3	7	11	
Node 7: Installation Hazards	1	1	11	
Node 8: Hazards in Port & SIMOPs				
Node 9: Maintenance and Inspection			2	
Node 10: Materials				
Node 11: Manufacturing				
Node 12: Hydraulic System	1	5	4	
Node 13: Electrical System	1	1	1	
<b>Total</b>	<b>12</b>	<b>31</b>	<b>66</b>	

There were no unresolvable risks identified during the preliminary HAZID that would prevent further development of the General Cargo vessel using VentoFoil system. Appendix VI – List of Recommendations General Cargo vessel using VentoFoil© (Suction Wings) provides a summary of the recommendations from the HAZID register with applicable nodes for the HAZID scenarios.

The key findings and recommendations from the HAZID study and the additional risks that would need to be addressed are summarised below:

- Sensors to monitor loads on the foundation.
- Address alternatives for visibility.
- Design criteria for VentoFoil structure considering the max anticipated wind speed and operational restrictions are to be developed.
- Design needs to consider the fatigue analysis and are to be performed/updated.
- Slew bearing has to be selected considering the green waters.
- All mechanical components and materials are to be selected appropriately to deal with the green water.
- Take into consideration ice conditions to stability calculations.
- Consider max 30 degree in the hydraulic design and avoid spillage by providing appropriate height to the breathing goose neck on the hydraulic unit oil tank.
- Hydraulic system to add hydraulic damper to avoid hydraulic vibrations.
- For each installation vibration survey can be considered.
- Eigenfrequency vibration to wind excitation can be resolved by trimming the VentoFoil slightly off weather vanning.
- Hull slamming vibrations can be considered in the design, if applicable.
- Proper operational procedures and safety measures are to be further studied in case of high wind situation or in case of malfunction of hydraulics of wings.
- Work with Flag State for the exemptions for the navigation lights and bridge view obstruction
- Position of the VentoFoil to take under consideration the obstruction issues in advance (design phase)
- Location of VentoFoil to be selected to avoid obstructions and blockages of walkways.



- Specific calculations to be performed for the stability and work with the Classification Society (e.g., static dynamic damage, considering VentoFoil fully deployed), taking into account the potential effect of damping and additional heeling moment.
- For each ship type, studies are to be performed considering the various cargo operations and their impact to the VentoFoil and its position.
- Impact on the rudder loads is to be further studied due to additional loads created from the VentoFoil
- Manoeuvrability studies are to be conducted considering the number and locations of the VentoFoil
- Operation manual to include resting procedures.
- At initial stage of the project, proper location of the VentoFoil to also consider economic benefits.
- Studies to be performed to determine any change needed for mooring and anchor equipment and capacity.
- Increased speed impact to be further looked at from a fuel saving perspective and structural issues.
- Impact on the tonnage to be studied and booklets are to reflect that (to be updated accordingly)
- All the equipment to be selected according to the marine operating environment.
- The fire consequences are to be further studied depending on the various ship types and consider fire hydrants to spray the water.
- All electrical cables are to be certified for marine environment.
- Further studies to be performed for corrosion potentials and proper quality checks during manufacturing and in service inspection procedures to be established.
- Based on the Safety Data Sheet (SDS data further studies to be done for any chance for pollution and consider scenarios to contain the potential leak during the operations or maintenance
- Such scenario is to be further evaluated and safety detections are to be provided.
- Consider regular inspection to see if there is clogging on the hydraulic system filter.
- Further studies to be done and proper fluid or heat tracing to be considered.
- Fire firefighting mitigations and philosophy to be considered.
- Depending on the ship types and hazardous areas appropriate protection equipment are to be selected depending on the hazards.
- Consider equipment suitable and certified for marine environment/operation.
- Operations manual to include check before raising or lowering e.g., that nobody is in the area, no other operations are happening, cranes, obstructions etc.
- Design to consider VentoFoil contact area at the boom rest considering loads due to the resting.
- If radar is blocked, consider installing additional radar units.
- Investigate and provide appropriate action plan for the system recovery (putting VentoFoil in safe position)
- Proper system level FMECA needs to be performed.
- Design limitations are to be considered for the VentoFoil
- Water drainage from the VentoFoil is to be further studied considering green water, ice formation inside, heavy rain.
- Depending on the ship types (freeboard etc.) impact of sea water should be further studied.
- Impact on the buoyancy due to the green water is to be considered.
- If VentoFoil is up, owner to perform operational study.
- Consider providing warning lights in case VentoFoil is sticking out in down position.
- Raising and lowering in bad weather are to be further studied and appropriate mitigations and recommendations are to be provided to the crew and added to the manual.
- Boom rest and lashing are to be designed considering the worst load condition during any operational phase.
- Survey of fire hazards on areas of VentoFoil installation to be performed.
- Perform separate HAZID and SIMOPS with the owner of such vessels (special purpose ships) for Ventofoil operation.
- Handling maintenance procedures to be developed and incorporated in the manuals.
- Ship's procedure to include personal protective equipment (PPE).

This general cargo ship presented characteristics of both container ship and bulk carrier. It is noted that the overall risk is not expected to be different for these vessel types. For bulk carriers, when the Ventofoil system is installed between two cargo holds there is risk of collision with VentoFoil and cargo loading/unloading equipment/crane and this would need further evaluation. For a container ship, due to arrangement and containers on deck, most likely a single system will be installed in the forward area of ship.

### 4.3.3 Wind Propelled H<sub>2</sub> Assisted Container Carrier

The proposed vessel has been designed to operate as an absolute zero-emission vessel as defined by the IMO in reference ISWG-GHG 13/3/9, a vessel that produces “no emissions of carbon dioxide (CO<sub>2</sub>) or other greenhouse gases (GHG) across all scopes, i.e., where there are no direct emissions from fuel consumption or indirect emissions from energy purchased or any GHG emissions from production to end use.”

The design and construction of the vessel also emphasises the importance of minimising the vessel's environmental impact on both water and air, minimising underwater and airborne radiated noise, ballast water, wastewater and oily water discharge and overall increased energy efficiency.

To achieve the above, the proposed wind powered container carrier is outfitted with three masts spreading almost 3,200 m<sup>2</sup> of sail area and a hydrogen (H<sub>2</sub>) fuel cell assisted propulsion system with a capacity of 152 TEUs. The sailing container carrier is designed to be primarily wind powered with a provision for an electrically driven auxiliary propulsion system which uses H<sub>2</sub> powered fuel cells to generate electrical power with a Li-Ion battery buffer.

The highly automated sail system has the following key characteristics:

- unrestricted ocean service (North Atlantic sea conditions)
- system can be reefed to reduce sail area for heavy weather operations
- free-standing rotating mast
- automated sail handling system from bridge control station
- mast load monitoring system
- bearing/mast rotation unit at mast heel, electrically driven for rotation of the rig
- permanently installed man aloft system maintenance/inspection, normal operations do not require work aloft
- full sail plan can be se/furled in 6 mins
- masts can rotate +/- 90 deg
- lightning protection system
- rig certification: design validated by over 25 years combined use on two large private yachts, rig load stress and strain data collected, sail handling/reefing sequences, maintenance scheduling, operational manuals, emergency processes, etc.

Figure 22 shows the general arrangements of the vessel with three large masts installed to harvest wind power and provide primary propulsion power for the vessel. The three (3) free-standing carbon fibre masts are supported by the hull and each mast has five tiers of sails with an air draft of approximately 62.5 metres.

Aft of the forward accommodations are three (3) holds. Hold No. 1 and Hold No. 2 each carry 52 TEU twenty-foot ISO containers in cell guides. On deck there is stowage for 48 twenty-foot ISO containers, including 12 reefer containers. The total cargo TEU capacity is 152. The third hold is reserved for the carriage of hydrogen fuel storage containers with a 1m cofferdam surrounding this hold.

The current concept design considers three modes of sailing: sailing without any auxiliary propulsion, sailing with the auxiliary propulsion system in regeneration mode, and sailing with the assistance of the auxiliary propulsion. The final system requirements will be determined at a later engineering stage when a candidate route is selected.

The vessel general arrangement includes the following features:

- Cargo cranes are installed onboard to load and unload the cargo containers.
- The cargo containers will be stored in cargo hold 1 and 2. Pontoon hatch covers will provide watertight closure over the cargo holds and allow one level of containers to be stored on top of the hatches.
- The vessel bridge and accommodations are forward while the H<sub>2</sub> storage and fuel cell systems are located aft.



- The aft most Hold No.3 is dedicated to the carriage of compressed gaseous hydrogen fuel in forty-foot ISO containers. Hold No. 3 has no hatch cover over the storage area.
- Two battery rooms, located starboard and port, house the lithium ion (Li-Ion) battery energy storage system. The selection of battery energy storage system model and vendor will be determined at a later engineering stage.
- Two fuel cell rooms are located port and sideboard, adjacent to the H<sub>2</sub> storage area. Proton Exchange Membrane (PEM) type fuel cell systems are considered for the current design, but the selection of fuel cell system model and vendor will be determined at a later engineering stage.

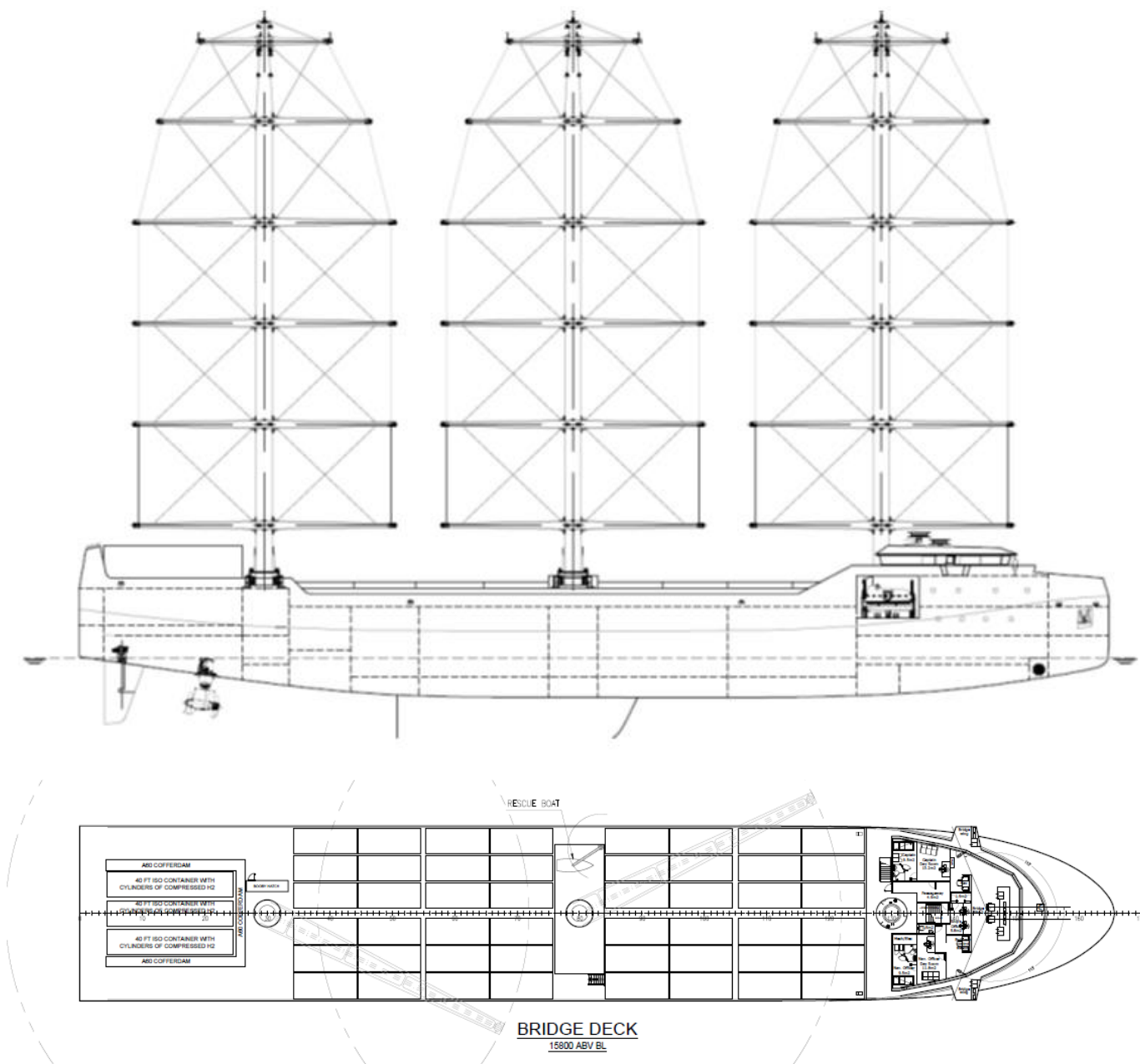

Figure 22. Vessel's profile with sail plan and bridge deck.

#### 4.3.3.1 Assumptions – Wind Propelled H<sub>2</sub> Assisted Container Carrier

In addition to the assumptions listed above, other key design parameters are listed below:

- Vessel is designed to meet classification society rules and IMO regulations. An Approval in Principle has been granted by ABS Classification Society.
- Current design does not consider sailing in areas where icing is highly likely.
- All electric power will be provided by Fuel Cell (FC) and Li-Ion Batteries.
- H<sub>2</sub> storage will use Carbon Composite Pressure Vessels.
- H<sub>2</sub> storage will be protected by Thermal Protection Relief Devices and relief valves.
- Entering and leaving port and in narrow channels, the vessel will utilise its auxiliary propulsion system.
- Emergency Independent electric power generation will be provided.

#### 4.3.3.2 Results and Recommendations

The results of the HAZID workshop are to be analysed and incorporated into the design. A list of recommendations and the HAZID register are in Appendix VIII – List of Recommendations Wind Propelled H<sub>2</sub> Assisted Container Carrier and Appendix IX – HAZID Register Wind Propelled H<sub>2</sub> Assisted Container Carrier. System and operational level nodes, along with the scenarios associated with each node, were discussed. Where the risk was deemed to be high, recommendations were developed from the scenarios identified during the workshop.

The HAZID register identifies the hazards and documents the recommendations from the workshop's discussions. Due to proprietary information of VEER Group, some nodes and related hazards, mainly referring to H<sub>2</sub> and FC have been removed. Summary Table 28 is presented below. Three (3) Extreme and Twenty-Five (25) 'high' risk scenarios are presented that will require mitigation as the design progresses. Each of those have recommendations listed in the HAZID register.

Table 28. Wind Propelled H<sub>2</sub> Assisted Container Carrier – HAZID Risk Ranking Summary.

Key system level HAZID nodes*	Risk Ranking of Hazards Identified			
	Low	Moderate	High	Extreme
Node 1 : Vessel General Arrangement		2	6	2
Node 8 : Ventilation system – H <sub>2</sub> storage, FPR, FC, Li-Ion other close spaces		3		
Node 11 : Sails	3	43	17	1
Node 12 : Cargo loading/unloading operations		4	2	
Node 14 : Maintenance & Inspection				
<b>Total*</b>	<b>3</b>	<b>52</b>	<b>25</b>	<b>3</b>

*\*Due to proprietary right of VEER Group, some nodes and related hazards have been removed, mainly referring to H<sub>2</sub> and FC related hazards. Therefore, numbering is not continuous.*

There were no unresolvable risks identified during the preliminary HAZID that would prevent further development of the zero-emission container cargo vessel using sails as main propulsion, with H<sub>2</sub> Fuel Cell assisted propulsion. Appendix VIII – List of Recommendations Wind Propelled H<sub>2</sub> Assisted Container Carrier provides a summary of the recommendations from the HAZID register with applicable nodes for the HAZID scenarios.

The key findings and recommendations from the HAZID study and the additional risks that would need to be addressed, related to the sail system, are summarised below:

- Additional risk assessment studies -- such as gas-dispersion, fire and blast analyses -- are to be conducted as the design is further developed.
- Sails provider to investigate any possibility of water exposure damaging electrical equipment for the sail system (e.g., bearing damage due to water exposure), and due to the open deck, consider a minimum IP56 electrical rating for electrical equipment.

- At a later design stage when the additional details are available, it is recommended to conduct a HAZOP study to validate design changes, system integration, confirm concept design risk profile maturity, assess additional hazards and ensure safeguards are in place to address the hazards. The focus should be on H<sub>2</sub> storage system to fuel cell room and battery Energy Storage System (ESS), sail mast obstruction with hazardous area zone established by H<sub>2</sub> storage bay and emergency power system, and the hazardous area zones from H<sub>2</sub> storage bay and emergency power system equipment and any ventilation exhaust or hazardous area exhaust.
- Reliability, Availability and Maintainability (RAM) analysis to be conducted at later stage of design.
- Crane/sail collision study to be performed and appropriate control and procedure are to be developed to avoid any collision possibility.
- Training programme to be developed for crew considering the new technology installed on ship.
- Develop vessel operation manual considering the selected ports, port requirements, vessel manoeuvrability and air gap requirement.
- Consider providing bilge system to remove water in case of water ingress to avoid water ingress to bearings and sail mast openings.
- Consider Cybersecurity Class Notation for the remote-control functionality of the sail system.
- Remote control and main control for the sails system are to be investigated further in FMECA study; the appropriate class requirements and notations are to be considered.
- Operation manual/procedure to determine the appropriate weather conditions (including wind speed, vessel motion) for safe working conditions in case of emergency.
- Develop vessel procedures and provide appropriate PPE with recommendations from sail provider on emergency procedures for operator injuries, man overboard scenarios, emergency rescue activities.
- Develop proper procedures for inspection and maintenance activities and detailed procedures for operator working at height (man aloft). Proper Job Safety Analysis (JSA) and operator training are to be developed.
- Conduct vessel manoeuvrability study for when vessel is in port without sailing using only auxiliary propulsion system (fuel cell, battery system) and the power requirement.
- Conduct a Vessel Collision Study and investigate potential vessel grounding/collision scenarios and the impact on the sails, yards and masts. Verify the structural integrity of the sails, yards, masts and select the materials accordingly.
- Investigate availability of backup power and redundant power supply to the Sails Control system and Mast Rotation Unit considering single failure.
- Investigate the potential obstruction with sail mast (electrical equipment, 25 motors/sail mast) and the hazardous area zones from H<sub>2</sub> storage bay and emergency power system equipment and any ventilation exhaust or hazardous area exhaust.
- Consider the impact of cargo container fire on sails and sail equipment (e.g., the motor) with recommendations from sails provider.
- Since the proposed design is to install the crane on the sail mast, investigate the fatigue cycles of mast rotation unit with crane use.

It is also observed that the hazards identified are mainly related to the WAPS rather than the ship type or ship size. Therefore, these could be considered applicable to larger ship sizes, though perhaps some additional hazards may emerge depending on the size and the specific design.

#### 4.4 Overall conclusion on WAPS HAZIDs

The HAZID studies demonstrated that the major concerns related to WAPS for shipping are related to vessel's stability and manoeuvrability, change in air-draft, operational and navigational obstructions, obstruction in cargo loading/unloading (e.g., for bulk carrier) impact of adverse weather, ice accumulation, fire and lightning protection, noise and vibrations, system and component failures, maintenance, fire detection and firefighting.

These issues require further studies to understand the risks and additional safeguards that will need to be implemented to prevent or mitigate the major hazards. In addition, the reliability and availability of the WAPS may need to be further improved to realise the full potential benefit of the technology.

The HAZID studies identified preventive and mitigative safeguards and recommendations for various ship types. While some safeguards are regulatory requirements, many are not found in the regulations and are considered additional due to the inherent risks of WAPS. The study did not identify major risks that cannot be resolved.

However, to encourage a wider uptake on commercial vessels, additional cost-benefit analysis is needed, in addition to higher reliability and availability of the systems. It is also suggested to further investigate the structural integrity of the installations in more detail. As each technology develops there will be better understanding of the forces acting the ship 's structure.

The safeguards and recommendations listed in this study will contribute to further reducing the inherited risks. Not all safeguards and recommendations listed in the HAZID registers will be applicable to all ship types. Some are obviously practical and of benefit, but others may require further investigation of their merits. However, they are all listed for consideration and may help to inform prescriptive requirements and develop inherently safer designs and arrangements.

Table 29. Summary of main hazards and causes from HAZID studies.

System/Area	Hazards	Causes
<b>Overall WAPS</b>	Increased air draft	- height of WAPS
	Stability issues	- additional heeling moment - excessive motions - high winds - WAPS weight
	Manoeuvring performance	- WAPS windage area
	Navigational obstruction	- WAPS forward of bridge
<b>Power Supply</b>	Harmonics	- variable frequency drive(s)
	Electrical load balance	- increase in electrical load
	Blackout on ship	- integration into Power Management System (PMS)
<b>Maintenance</b>	Confined space	- ventilation
	Working at height	- dropped object - falling - slip, trip fall
<b>Dropped Object</b>	Kinetic energy	- loose item falling, loose bolt/nuts
	Working at height	- dropping of equipment, tools etc.
<b>Cargo loading/unloading (Bulk carrier)</b>	Obstruction	- port cargo equipment/Crane movement
	Collision	- port cargo equipment/Crane colliding with WAPS
<b>Icing</b>	Ice load	- ice build-up
	Ice falling on vessel' structure	
	Stability issues	
<b>Vibration</b>	Noise and Vibration	- ship propeller - ship Engine - bow slamming - WAPS rotating units - WAPS motor, gear box, bearing
<b>Fire detection and fire fighting</b>	Fire	- electrical short circuit
		- bearing failure
		- lube oil - bearing, Gear box
		- overheating of motor
<b>Hydraulic system</b>	WAPS failing	- hydraulic control failure - cylinder failure
	Slip, trip, falls	- hydraulic fluid leakage on floor
<b>Mooring</b>	Obstruction	- size and foundation of WAPS - mooring line
	Communication	- unable to see crew member on deck, at port or on tug
	Snap Back	- mooring lines under tension close to WAPS
<b>WAPS Control</b>	Ship blackout	- higher demand than available load

System/Area	Hazards	Causes
	Instrument	<ul style="list-style-type: none"><li>- wrong input</li><li>- anemometer, accelerometer</li></ul>
Hydraulic, gear and lube oil	Spill/pollution	<ul style="list-style-type: none"><li>- hydraulic, lube oil</li><li>- bearing, gear box</li></ul>

## 5. Overall conclusions of WAPS study

With wind being a free and ample source of sustainable energy, wind-assisted propulsion is seen as a technology that could reduce the greenhouse gas (GHG) emissions from ships and contribute to global maritime decarbonisation efforts. Industry-wide experience has not, to this point, revealed any serious obstacles to their adoption.

As presented in this study, there is a variety of systems available, some of which are still in the development stage. The current limited availability of WAPSs in the market can be considered only a short-term barrier to their wider adoption. While the number of commercial vessels with WAPS installed is currently low, the interest in such systems is growing due to their potential to supplement vessel's main engine power and to lower vessel's fuel consumption and associated emissions.

The savings from a specific WAPS, can be determined based on numerical simulations and/or actual measurements. The exact reduction potential is, however, difficult to estimate, since this depends on a large variety of factors, including the type and size of WAPS, the number of units deployed, the operating profile of the vessel and environmental factors. Crew training is considered another important factor. In this study, publicly available results from numerical simulations and measurements, assessing the fuel and emission reduction potential from WAPSs, have been gathered. A big variation in the savings has been observed due to the reasons stated above. Nevertheless, it can be concluded that under favourable environmental conditions the savings can be significant. As an example, rotor sails, which is the technology with the most available data, revealed up to 30% savings.

Naturally, the availability of wind greatly affects the performance of WAPS. This depends on the route, but also on seasonal variations and the exact angle of the vessel towards the wind. Therefore, the routes on which the ship will travel need to be carefully selected and adjusted to find a balance between wind availability and the distance travelled. Voyage optimization is, thus, considered critical to maximise the savings.

Larger vessels are typically engaged in open seas, where higher wind speeds are usually found. These vessels also tend to have more available deck space, which seems to be necessary for most WAPSs, supporting the installation of a higher number of WAPS units with relatively low interaction (which can reduce efficiency) between the systems. However, many of these vessels are engaged in tramp trades (unknown routes) with a lower predictability of savings.

For the purpose of this study, given the variety of factors determining the WAPS performance, the required relative savings from the main engine's fuel consumption to cover the annualised costs (over 15-years period) from WAPS have been calculated for the various vessel segments. This approach has been selected as an alternative to calculating the return on investment based on the expected savings from the different WAPS. While the analysis is done to give a first insight on the potential profitability, the variations of the expected savings together with the uncertainty around the quality of the data create a need for assessments to be made on a case-by-case basis.

It is difficult to compare results for the different segments since different number of units, of different size have been assumed to be installed, as considered more suitable. This has an impact on the assumed costs and consequently on the required savings but also on the expected savings. Therefore, the calculated required relative savings can only be used as an indication for the assumed number and size of units assumed for each segment. As an example, on a capsized bulk carrier, four large units have been assumed to be installed, resulting in higher required savings. On the other hand, on cruise ships, only one or two units have been assumed, resulting in lower the required savings.

It has also been observed that compared to smaller and slower ships, larger and faster ships have higher fuel consumption and therefore, lower relative savings are needed to break even when considering the same system costs. Moreover, vessels with a higher share of auxiliary engine consumption might be found to be less attractive applications, since WAPS can only contribute to main engine fuel consumption savings.

The relative fuel savings required to break even is expected to decrease in the future. This due to the expected decrease of WAPS costs over time but also because more expensive renewable fuels are expected to capture a greater share of the marine fuel market. Nonetheless, somewhat lower savings from carbon-related costs can be expected when renewable fuels are used.

The existing regulatory framework would play a major role in contributing to or restraining the adoption of a new technologies such as WAPS, so this has been investigated in detail. There are several regulations, standards and guidelines which may need to be refined to apply to WAPS, including some of the unique characteristics they offer, such as tiltable/foldable options. These are mostly related to the vessel’s stability, manoeuvrability, navigational safety and EEDI-related requirements. To some extent, the current regulatory framework may pose a barrier to their adoption; a more unified approach would be preferable.

The risk analyses included in this study demonstrated that the major concerns regarding the use of WAPS for shipping are related to vessel stability and manoeuvrability, changes in air-draft, operational and navigational obstructions, obstruction to cargo loading/unloading (e.g., for bulk carriers), impacts from adverse weather, ice accumulation, fire and lightning protection, noise and vibrations, system and component failures, maintenance, as well as fire detection and firefighting. These issues may require further studies for better understanding and for identifying the necessary safeguards that could prevent or mitigate any major hazards. Overall, no major risks have been identified that cannot be resolved.

To conclude, wind-assisted propulsion is considered to have potential for the shipping industry, a potential that varies between shipping segments and the WAPS technologies. To facilitate a wider and safer adoption of WAPS on commercial vessels, additional safeguards may be needed, and the current regulatory framework will need to be updated to account for the specific characteristics of WAPS.

Table 30. Summary of the Observations.

Subject	Observation/Mitigations/Suggestions
<p style="text-align: center;"><b>Sustainability</b></p>	<p><b>Observation</b></p> <ul style="list-style-type: none"> <li>• WAPSs can contribute to lowering ships’ GHG emissions, air pollution and underwater noise emissions if the system is used to replace main engine power with wind power, lowering main engine fuel consumption.</li> <li>• The use of WAPS can, under optimal conditions, lead to significant fuel consumption and emission savings.</li> <li>• The amount by which the fuel consumption (and GHG emissions) can be reduced depends on a broad range of technological, environmental and operational factors, making it very difficult to pinpoint the general effectiveness of a WAPS.</li> <li>• Some calculation tools have been developed to offer an idea of the fuel-reduction potential.</li> <li>• Savings provided by different technology providers, researchers and tools are not always comparable, nor applicable to all vessel types.</li> </ul> <p><b>Mitigation and suggestions</b></p> <ul style="list-style-type: none"> <li>• A ship and WAPS specific analysis is required, considering the hydrodynamic and aerodynamic characteristics but also the intended operational profile and routes.</li> <li>• Crew training and voyage optimization are considered crucial for the effective use of WAPS.</li> </ul>
<p style="text-align: center;"><b>Availability</b></p>	<p><b>Observation</b></p> <ul style="list-style-type: none"> <li>• The current production capacity of technology providers varies greatly and, in the short run, there may be a shortage of available systems. In the medium- and long-terms, however, expanding production is not considered a barrier to the use of WAPS.</li> </ul>



Subject	Observation/Mitigations/Suggestions
	<ul style="list-style-type: none"> <li>• The efficiency of a WAPS is largely dependent on the availability of wind on the routes being sailed. This, in turn, depends significantly on the specific route, the route direction, the seasonal variations and the proximity of the water to land.</li> </ul> <p><b>Mitigations and Suggestions:</b></p> <ul style="list-style-type: none"> <li>• To gain maximum efficiency from WAPS, trade routes may have to be adjusted to find the perfect balance between available wind and route length. Voyage optimisation systems are considered beneficial in this context. However, for vessels with fixed routes and schedules such as ferries or container ships, this might not be an option.</li> <li>• The deployment of vessels with WAPS to specific trading areas with more beneficial wind speed and direction could be considered; the optimal conditions will differ between the different types of WAPS.</li> </ul>
<p style="text-align: center;"><b>Suitability</b></p>	<p><b>Observation</b></p> <ul style="list-style-type: none"> <li>• For most WAPS, adequate deck space is required, the availability of which depends on the ship’s size and type. Bulk carriers, general cargo ships, tankers and gas carriers are most promising in this respect. Ro-Ro and passenger ships also have potential, although passenger ships have relatively less deck space.</li> <li>• Very small ships probably have insufficient deck space; the adequate dimensions of the WAPS might not be available.</li> <li>• There are different placement criteria, especially for passenger ships, which need to be fulfilled to support the safe and comfortable use of WAPS.</li> <li>• The ship structure should allow for the safe transmittance of the forces generated by the WAPS onto the ship.</li> </ul> <p><b>Mitigations and Suggestions:</b></p> <ul style="list-style-type: none"> <li>• Ships might need to be reinforced to allow the safe transmittance of the forces generated. But, since currently most installations of WAPS are retrofits, this does not appear to be an insurmountable technical or financial barrier.</li> <li>• For ships with relatively little deck space, a kite or an innovative solution such as a towing tug (equipped with WAPS) or a ‘containerised’ solution, are alternative options.</li> <li>• To avoid interference with cargo handling and infrastructure on land -- and to avoid undesired effects at high wind speeds -- many systems are designed to be flexible (e.g., foldable or tiltable).</li> </ul>
<p style="text-align: center;"><b>Techno-economical</b></p>	<p><b>Observation</b></p> <ul style="list-style-type: none"> <li>• The uncertainty on the data is rather high. Any change in the input/assumptions may have a positive/negative impact on the potential profitability.</li> <li>• The initial CAPEX assumption has a great impact on the results.</li> <li>• For the various ship segments, different number and size of WAPS units has been assumed. This has an impact on the assumed costs but also on the expected savings. Typically, on larger ships more deck space is available, allowing for more and larger WAPS units to be installed, with low interaction among them. For these vessels the required savings may be high, but the expected savings are also higher. On the other hand, for some vessels, such as cruise ships, only one or two units have been assumed. This lowers the required savings since lower costs have been assumed.</li> <li>• Independent of the type of WAPS, the relative amount of fuel that needs to be saved to cover the costs will decline over time, due to the increased use of more expensive renewable fuels; at the same time, the savings from lower carbon costs also can be expected to fall if renewable fuels are used. An anticipated decline in system costs will contribute to a decline in the fuel savings required to recover capital costs.</li> </ul>

Subject	Observation/Mitigations/Suggestions
	<ul style="list-style-type: none"> <li>• In general, larger ships and those that sail at higher speeds tend to feature comparatively greater annual fuel consumption and fuel costs compared to smaller and slower ships, which is why lower relative fuel savings are required for the former to cover the same system costs.</li> <li>• For ships with a relatively high share fuel consumption from their auxiliary engines, a WAPS might be a less attractive option compared to ships with a relatively high share of main engine fuel consumption.</li> <li>• For ships engaged in tramp trades, where route predictability is relatively lower, the profitability of the systems can be less certain.</li> </ul> <p><b>Mitigations and Suggestions:</b></p> <ul style="list-style-type: none"> <li>• Optimisation is a key: the optimal type of WAPS, the optimal number and dimension of the WAPS units -- as well as operating the vessels at optimal speeds on optimised routes – all play important roles in attaining the required reductions in emissions and fuel consumption.</li> <li>• The multitude of factors that would affect the WAPS selection, together with the uncertainty around the quality of the data sets create a need for assessments to be made on a case-by-case basis.</li> <li>• There are several financing options and performance guarantees for WAPSS available in the current market.</li> </ul>
<p><b>Rules and Regulation</b></p>	<p><b>Observation</b></p> <ul style="list-style-type: none"> <li>• There are current regulations, guidelines and standards for subjects such as EEDI, stability, maneuverability and course keeping, MPP, safe navigation and helicopter safety that have worked well for ships with conventional propulsion.</li> <li>• The IMO has published 2021 Guidance on Treatment of Innovative Energy Efficiency Technologies for Calculation and Verification of the Attained EEDI and EEXI MEPC.1/Circ. 896. This document provides a methodology to consider the contribution of WAPS to the EEDI/EEXI calculations.</li> <li>• The industry is making efforts to further improve the methodology and take WAPS into consideration for EEDI calculations and verifications.</li> <li>• The major classification societies have published rules and guides for ships installed with WAPS that cover loads, materials, mooring equipment, electrical systems, crew safety, lightning protection, survey and testing.</li> <li>• Currently, GHG regulations are being put in place in Europe via the ‘Fit-for-55’ initiative that should provide a regional framework to incentivise the adoption of WAPS.</li> </ul> <p><b>Mitigations and Suggestions:</b></p> <ul style="list-style-type: none"> <li>• Develop specific guidelines for the navigational safety of ships with WAPS that allow alternative methods to be used to compensate for the larger blind spots that are caused.</li> <li>• Investigate if the present criteria (IMO Standards for Ship Maneuverability, IS Code) and second generation of stability criteria need to be adapted to ships with WAPS.</li> <li>• Investigate if damage stability criteria should be adapted to ships with WAPS.</li> <li>• Investigate if the present criteria in the IMO Standards for Ship Maneuverability are applicable to ships with WAPS.</li> <li>• Develop a uniform methodology to calculate the EEDI and MPP.</li> <li>• Derive a practical methodology for assessing the contribution of WAPS to the EEDI/EEXI and make correspondent updates to regulation MEPC.1/Circ. 896.</li> <li>• Develop a standardised methodology for full-scale evaluation and verification of EEDI/EEXI for ships installed with WAPS.</li> </ul>

Subject	Observation/Mitigations/Suggestions
	<ul style="list-style-type: none"> <li>Clarify the categorisation of WAPS under non-conventional or hybrid propulsion and associated implications.</li> <li>Derive customised requirements to determine the loads of the different types of WAPS.</li> <li>Include the certification of the materials for various types of WAPS in the class rules.</li> <li>Evaluate whether class societies need to create UR (unified requirements) for some of key aspects of WAPS, including their structural loads, materials, electrical systems, crew safety, lightning protection, survey and testing, etc.</li> <li>Assess the impact of WAPS on helicopter-landing areas.</li> </ul>
<p style="text-align: center;"><b>Risk &amp; Safety</b></p>	<p><b>Observation</b></p> <ul style="list-style-type: none"> <li>Due to the increase in windage area, vessel stability and manoeuvrability need to be evaluated.</li> <li>Another concern for WAPS is obstruction to visibility, navigation lighting and radar, depending on size of ship and number of systems installed.</li> <li>Due to the height of WAPS, the air draft is higher than normal and requires special consideration.</li> <li>It is required to perform maintenance inside WAPS either in upright or horizontal position, creating confined spaces.</li> <li>Icing on WAPS surface in cold weather, creating issues with stability.</li> <li>Cargo loading/unloading operations on some vessel types (e.g., bulk carrier) may create additional hazards due to the possibility of the cargo-loading system colliding with the WAPS.</li> <li>Due to the potential for obstruction with communications and interference with mooring lines, mooring operations require special attention.</li> <li>Special attention also needs to be paid to where the WAPS is installed relative to the helipad is on deck to ensure no obstruction/interference to helicopter operations is caused.</li> <li>WAPS control systems are highly automated. This can create problems if verifications/validations are not carried out.</li> <li>WAPS ventilation: cylinders should be closed and only opened at the bottom.</li> <li>Tilting systems can suddenly drop WAPS onto the deck if systems malfunction.</li> <li>Potential for issues with harmonics due to WAPS Variable Frequency Drive.</li> <li>Most systems require maintenance. This can create hazards for the crew.</li> </ul> <p><b>Mitigations and Suggestions:</b></p> <ul style="list-style-type: none"> <li>Flag Administration to be contacted for issues related to obstructed visibility, navigation lighting and radar. An additional mast forward of the ship could be installed, along with a camera to increase visibility.</li> <li>Higher air draft routes and port study could be conducted to verify that the ship still can enter and depart port.</li> <li>To prevent icing, special coatings are to be applied, or minimum rotation (for rotor sails) needs to be maintained. This issue requires additional research, as it can prevent WAPS operations in icy conditions.</li> <li>Tilting hydraulic systems are to be designed to prevent sudden falls of WAPS.</li> <li>System to be designed and tested to prevent harmonics. Control system to get through validation and verification.</li> <li>Functional testing at shipyard during construction to verify all functionality of WAPS.</li> </ul>

Subject	Observation/Mitigations/Suggestions
	<ul style="list-style-type: none"><li data-bbox="483 241 1450 302">• Vibration survey and measurement during sea trial to be conducted.</li></ul>

## References

- 2022 Guidelines on Survey and Certification of the Energy Efficiency Design Index (EEDI), MEPC.365(79). (2022).
- ABS Guide for Wind Assisted Propulsion System Installation. (2021).
- Air Pollution and Energy Efficiency, Findings on the EEDI Assessment Framework for Wind Propulsion Systems, MEPC 74/INF.39. (2019).
- Ariffin, N. I., & Hannan, M. A. (2020). Wingsail technology as a sustainable alternative to fossil fuel. *Materials Science and Engineering, Volume 788*, pp. 1-12.
- Bentin, M., Zastrau, D., Schlaak, M., Freye, D., Elsner, R., & Stephan, K. (2016). A new routing optimization tool-influence of wind and waves on fuel consumption of ships with and without wind assisted ship propulsion systems. *Transportation Research Procedia, Volume 14*, pp. 153-162.
- Bordogna, S. G., Muggiasca, S., Giappino, S., Belloli, M., Keuning, J., & Huijsmans, R. (2020). The effects of the aerodynamic interaction on the performance of two Flettner rotors. *Journal of Wind Engineering and Industrial Aerodynamics, Volume 196*.
- Borren, M. (2022). *The assessment of aerodynamic interaction between Ventifoil suction wings*.
- bound4blue. (2023). *eSail system technical specifications*.
- bound4blue. (2023). *Public Grants & Investors*. Retrieved from <https://bound4blue.com/public-grants/>
- Bureau Veritas. (2021, December). *Bureau Veritas validates wind assisted propulsion system for a 1,800 TEU container vessel*. Retrieved from <https://marine-offshore.bureauveritas.com/newsroom/bureau-veritas-validates-wind-assisted-propulsion-system-1800-teu-container-vessel>
- BV NR 206 Wind Propulsion System. (2021).
- CAP 437 Standards for Offshore Helicopter Landing Areas. (2021).
- (2023). *CCS Guidelines for Survey of Marine Wind-Rotor Assisted Propulsion System*.
- CE Delft. (2022). *Blue Speeds for shipping, Economic analysis and legal framework to achieve*. Delft: CE Delft.
- CE Delft, Tyndall Centre, Fraunhofer ISI, Chalmers University. (2016). *Study on the analysis of market potentials and market barriers for wind propulsion technologies for ships*. Delft: CE Delft.
- Chambers, S. (2023). *Norsepower gets state funds to expand*. Retrieved from [Splash247.com: https://splash247.com/norsepower-gets-state-funds-to-expand/](https://splash247.com/norsepower-gets-state-funds-to-expand/)
- Chou, T., Kosmas, V., Acciaro, M., & Renken, K. (2021). A Comeback of Wind Power in Shipping: An Economic and Operational Review on the Wind-Assisted Ship Propulsion Technology. *Sustainability, Volume 13, Issue 4*.
- Class NK Guidelines for Wind-Assisted Propulsion System for Ships. (2019).
- Convention on the International Regulations for Preventing Collisions at Sea 1972 . (n.d.).
- Dadd, G., Hudson, D., & Sheno, R. (2010). *Comparison of Two Kite Force Models with Experiment*. Journal of Aircraft.
- Decarbonisation of Shipping - Technical Study on the Future of the Ship Energy Efficiency Design Index, European Commission. (2021).
- Díaz, D. G. (2020). *Study and analysis of the use of wind power for the propulsion of merchant vessels. Case study*.
- DNV. (2021). *First DNV SILENT-E class notation awarded to a merchant vessel*. Retrieved from Maritime impact: <https://www.dnv.com/expert-story/maritime-impact/First-DNV-SILENT-E-class-notation-awarded-to-a-merchant-vessel.html>

- DNV. (2023, June). *Martitime impact*. Retrieved from Wind propulsion for RoRo, RoPax and pax vessels: <https://www.dnv.com/expert-story/maritime-impact/Wind-propulsion-for-ro-ro-ropax-and-pax-vessels.html>
- DNV-ST-0511, Wind Assisted Propulsion Systems. (2021).
- EC. (2020). *2030 Climate Target Plan; Published Initiatives, Law, European Commission*. Retrieved 2022, from [https://ec.europa.eu/info/law/better-regulation/have-your-say/initiatives/12265-2030-Climate-Target-Plan\\_en](https://ec.europa.eu/info/law/better-regulation/have-your-say/initiatives/12265-2030-Climate-Target-Plan_en)
- EC. (2021). *Proposal revision EU ETS*. Brussels, BE: European Commission.
- Epanenchnikov, V. A. (1969). Non-Parametric Estimation of a Multivariate Probability Density. *Theory of Probability & Its Applications*, 14(1), 153-158.
- Ferry Shipping News. (2023, September). *Ferry Shipping News*. Retrieved from Brittany Ferries announces the use of the inflatable wing sail prototype Wisamo on Ro-Ro PELICAN: <https://ferryshippingnews.com/brittany-ferries-announces-the-use-of-the-inflatable-wing-sail-prototype-wisamo-on-ro-ro-pelican/>
- Guidance on Treatment of Innovative Energy Efficiency Technologies for Calculation and Verification of the Attained EEDI and EEXI, MEPC.1/Circ 896. (2021).
- Guidelines for Determining Minimum Propulsion Power to Maintain the Maneuverability of Ships in Adverse Conditions, MEPC.1/Circ.850. (2021).
- Guidelines for the Assessment of Speed and Power Performance by Analysis of Speed Trial Data, ISO 15016:2015. (n.d.).
- Guidelines for the Installation of Shipborne Radar Equipment, SN1/Circ.271 . (2008).
- Guidelines on the Method of Calculation of the Attained Energy Efficiency Design Index (EEDI) for New Ships, MEPC.308(73). (2018).
- HariPriyono, A., Yaseen, Y., & Hannan, M. (2021, Issue 11 (2021)). Impact of Wind-Assisted Technologies on Resistance and Stability of. *CFD Letters*, pp. 95-115.
- HXX Blue. (2023). *Financial Model*. Retrieved from a relatively high share of auxiliary engine fuel consumption
- IMO. (2020). *Fourth IMO GHG Study 2020*. London, UK: International Maritime Organization.
- (2009). *IMO Intact Stability Code*.
- IMO SDC 7/WP.6 Report of the Drafting Group on Intact Stability. (2020).
- IWSA. (2023, July). *Newsletter: July 2023*. Retrieved from <https://www.wind-ship.org/wp-content/uploads/2023/09/IWSA-Newsletter-July-2023-General-Release.pdf>
- Kaneko, A., & Tsujimoto, M. (2021, Vol.6 No.2). Evaluation of Occurrence Probability of Winds for Use of Wind Propulsion System in Calculating Attained Energy Efficiency Design Index. *Transactions of Navigation*, pp. 77-84.
- Lee, H., Jo, Y., Lee, D.-J., & Choi, S. (2016). Surrogate model based design optimization of multiple wing sails considering flow interaction effect. *Ocean Engineering, Volume 121*, pp. 422-436.
- Lele Akshay, K. R. (2017). *Net Power Generated by Flettner Rotor for Different Values of Wind speed and Ship Speed*.
- Lloyd's Register. (2020). *Flettner rotor savings calculator*.
- LR Provisional Rules for Sail Assisted Ships . (2021).
- Lu, R., & Ringsberg, J. W. (2020). Ship energy performance study of three wind-assisted ship propulsion technologies including a parametric study of the Flettner rotor technology. *Ships and Offshore Structures, Volume 15, Issue 3*.

- Marin. (2022). *Performance prediction method Blueroute for wind-assisted ships*. Retrieved from <https://www.marin.nl/en/news/performance-prediction-method-blueroute-for-wind-assisted-ships>
- Marin. (n.d.). *Marin Blue Route*. Retrieved from <https://blueroute.application.marin.nl/>
- MarineLink. (2022). *World's First Coal Carrier Equipped with Wind Challenger Sail Marks Maiden Call in Australia*. Retrieved from MarineLink: <https://www.marinelink.com/news/worlds-first-coal-carrier-equipped-wind-500435>
- MARPOL ANNEX VI and NTC 2008. (2017).
- Mboumba Mboumba, D. (2022). *Analysis of wind assisted ship propulsion through 3D-computational fluid dynamics: application of rigid wind sails on a bulk carrier*.
- Michelin. (2022, Januari 13). *Michelin continues to develop WISAMO in partnership with Compagnie Maritime Nantaise – MN*. Retrieved from Michelin: <https://www.michelin.com/en/press-releases/michelin-continues-to-develop-wisamo-in-partnership-with-compagnie-maritime-nantaise-mn/>
- Misra-Godwin, D. (2016). *Let's Go Fly a Kite – SkySails and Climate Change*. Retrieved from Assignment: Climate Change Challenge: <https://d3.harvard.edu/platform-rctom/submission/lets-go-fly-a-kite-skysails-and-climate-change/>
- Moore, R. (2022, May). *Scandlines boosts wind power through retrofit*. Retrieved from Riviera Maritime: <https://www.rivieramm.com/news-content-hub/news-content-hub/scandlines-boosts-wind-power-through-retrofit-71155>
- MSC/Circ.1053, Explanatory Notes to the Standards for Ship Manoeuvrability. (2022).
- NAPA, Norsepower & Sumitomo. (2013, May). *NAPA, Norsepower and Sumitomo study finds average CO2 emissions reduction potential of up to 28% using rotor sails and voyage optimization*. Retrieved from NAPA: <https://www.napa.fi/news/napa-norsepower-sumitomo-study/>
- NASA. (2008, March 30). *Ocean Wind Power Maps Reveal Possible Wind Energy Sources*. Retrieved from News Topics - Earth: <https://www.nasa.gov/topics/earth/features/quikscat-20080709.html>
- Neoline. (2022). *Neoline chooses Chantiers de l'Atlantique's solid sail solution for the main propulsion of its first sailing cargo ship*. Retrieved from <https://www.neoline.eu/en/neoline-chooses-solidsail/>
- Norsepower. (2018). *Norsepower-Rotor-Sail-Solution-brochure*. Retrieved from <https://www.wind-ship.org/wp-content/uploads/2018/08/Norsepower-Rotor-Sail-Solution-brochure-2018.pdf>
- Norsepower. (2023a, March 30). *Norsepower receives financing from Nefco to expand Rotor Sail production in China*. Retrieved from Norsepower - News: <https://www.norsepower.com/post/norsepower-receives-financing-from-nefco-to-expand-rotor-sail-production-in>
- Norsepower. (2023b, March 30). *Climate Fund invests €10 million in Norsepower for accelerating emissions reductions in shipping*. Retrieved from Norsepower - News: <https://www.norsepower.com/post/climate-fund-invests-eur10-million-in-norsepower/>
- Norsepower. (n.d.). *Norsepower Performance Simulator*. Retrieved from <https://www.norsepower.com/performance-simulator/>
- Norsepower, Napa. (2022). *Voyage optimization with wind propulsion, International Conference on Computer Applications in Shipbuilding, 13th-15th of September 2022, Yokohama, Japan*.
- Ouchi, K., Uzawa, K., Kanai, A., & Katori, M. (2013). "Wind Challenger" the Next Generation Hybrid Sailing Vessel. In: J. Binns, R. Brown & N. Bose, eds. *Third International Symposium on Marine Propulsor - spm13* (pp. 562-567). Launceston: Australian Maritime College, University of Tasmania.
- Ovcina Mandra, J. (2022). *Michelin's Wing Sail Mobility (WISAMO) project has hit an important milestone with the launching of the installation of the company's wing sail on the first merchant ship*. Retrieved from Offshore Energy: <https://www.offshore-energy.biz/michelin-kicks-off-installation-of-its-1st-wisamo-wingsail-on-mn-pelican/>



- Pt 6-Ch 2-Sec 12, DNV-RU-SHIP, Wind Assisted Propulsion Systems. (n.d.).
- Reche-Vilanova, M., Hansen, H., & Bingham, H. B. (2021). Performance Prediction Program for Wind-Assisted Cargo Ships. *Journal of Sailing Technology, Volume 6, Issue 1*, pp. 91-117.
- Reduction of GHG Emissions from Ships, Wind Propulsion, MEPC 79/INF.21. (2022).
- Revised Explanatory Notes to the SOLAS Chapter II-1 Subdivision and Damage Stability, MSC.429(98). (2017).
- ScandiNAOS AB. (2013). *EffShip a project for sustainable shipping. WP9: EffShip Project Summary and Conclusions*. Göteborg: SSPA Sweden AB.
- Schenker, J. L. (2007, November). *SkySails: Greener Shipping with Kites*. Retrieved from Bloomberg.
- SideWind. (2023, June). *SideWind*. Retrieved from <https://www.sidewind.is/>
- Smith, T., Newton, P., Winn, G., & Grech La Rosa, A. (2013). *Analysis techniques for evaluating the fuel savings associated with wind assistance*. London: UCL.
- (2020). *SOLAS Consolidated Edition*.
- SSPA. (2022). *Speed trial and route analysis of m/v Annika Braren with rotor sail*.
- SSPA. (2022a). *Speed trial and route analysis of m/v Frisian Sea with suction wings*.
- SSPA. (2023). *Speed trial and route analysis of m/v Copenhagen with Flettner rotor*. Retrieved from [https://vb.northsearegion.eu/public/files/repository/20230505141934\\_RE40201042-01-revBCopenhagen.pdf](https://vb.northsearegion.eu/public/files/repository/20230505141934_RE40201042-01-revBCopenhagen.pdf)
- Standards for Ship Maneuverability, MSC 137 (76). (2002).
- Tasks and Structure of the 30th ITTC Technical Committees and Groups. (n.d.).
- The 2022 Guidelines on Survey and Certification of the Energy Efficiency Design Index (EEDI), MEPC.365(79). (2022).
- The 2022 Guidelines on the method of calculation of the attained energy efficiency design index (EEDI) for new ships, MEPC.364(79). (2022).
- Thies, F., & Ringsberg, J. W. (2021). Performance Prediction and Design of Wind-Assisted Propulsion. *International Conference on Wind Propulsion, 15-16 September 2021, London, UK*.
- Traut, M., Gilbert, P., Walsh, C., Bows, A., Filippone, A., Stansby, P., & Wood, R. (2014). Propulsive power contribution of a kite and a Flettner rotor on selected shipping routes. *Applied Energy, Volume 113*.
- Viola, I. M., Sacher, M., Xu, J., & Wang, F. (2015). A numerical method for the design of ships with wind-assisted propulsion. *Ocean Engineering, Volume 105*, pp. 33-42.
- WASP . (n.d.). *Ship profile MS Annika Braren*. Retrieved from <https://northsearegion.eu/wasp/our-technologies/flettner-rotor-eco-flettner/ship-profile-ms-annika-braren/>
- Werner, S., & Nisbet, J. (2022). Sea Trial Methodology for Wind Assisted Ships.
- WiSP2 Wind Assisted Propulsion. (2021). Retrieved from <https://www.marin.nl/en/jips/wisp-2>

## Appendix I – Symbols, Abbreviations and Acronyms

<b>ABS</b>	American Bureau of Shipping
<b>BV</b>	Bureau Veritas
<b>CAPEX</b>	Capital Expenditure
<b>cbm</b>	Cubic meter
<b>CII</b>	Carbon Intensity Indicator (IMO)
<b>CO<sub>2</sub></b>	Carbon Dioxide
<b>CO<sub>2</sub>e</b>	Carbon Dioxide equivalent
<b>CCPV</b>	Carbon Composite Pressure Vessel
<b>CCS</b>	China Classification Society
<b>DNV</b>	Det Norske Veritas
<b>EC</b>	European Commission
<b>EEDI</b>	Energy Efficiency Design Index (IMO)
<b>EER</b>	Escape, Evacuation, and Rescue
<b>EEXI</b>	Energy Efficiency Existing Ship Index (IMO)
<b>EMSA</b>	European Maritime Safety Agency
<b>EN</b>	Equipment Number
<b>ESSF</b>	European Sustainable Ship Forum
<b>EU</b>	European Union
<b>ETD</b>	Energy Taxation Directive
<b>ETS</b>	Emission Trading System
<b>FMECA</b>	Failure Mode Effects and Criticality Analysis
<b>FC</b>	Fuel Cell
<b>F&amp;G</b>	Fire and Gas
<b>GHG</b>	Greenhouse Gas
<b>GT</b>	Gross Tonnage
<b>JSA</b>	Job Safety Analysis
<b>H<sub>2</sub></b>	Hydrogen
<b>HAZID</b>	Hazard Identification Studies
<b>HFO</b>	Heavy Fuel Oil
<b>HP</b>	High-Pressure
<b>IACS</b>	International Association of Classification Societies
<b>IEEC</b>	International Energy Efficiency Certificate
<b>IMDG</b>	International Maritime Dangerous Goods
<b>IMO</b>	International Maritime Organization
<b>IGC</b>	International Code for the Construction and Equipment of Ships Carrying Liquefied Gases in Bulk
<b>IGF</b>	International Code of Safety for Ships Using Gases or Other Low-Flashpoint Fuels
<b>IS</b>	Intact Stability
<b>ISO</b>	International Organization for Standardization

<b>ITTC</b>	International Towing Tank Conference
<b>IWSA</b>	International Windship Association
<b>KR</b>	Korean Register
<b>LFO</b>	Light Fuel Oil
<b>LNG</b>	Liquefied Natural Gas
<b>LR</b>	Lloyd's Register
<b>MARPOL</b>	International Convention for the Prevention of Pollution from Ships (IMO)
<b>MCR</b>	Maximum Continuous Rating
<b>MDO</b>	Marine Diesel Oil
<b>ME</b>	Main Engine
<b>MEPC</b>	Marine Environment Protection Committee (IMO)
<b>MPP</b>	Minimum Propulsion Power
<b>MRV</b>	Monitoring, Reporting and Verification (EU)
<b>MSC</b>	Maritime Safety Committee (IMO)
<b>NDT</b>	Non-destructive testing
<b>NK</b>	Nippon Kaiji Kyokai
<b>NO<sub>x</sub></b>	Nitrogen Oxides
<b>OPEX</b>	Operational Expenditure
<b>PM</b>	Particulate Matter
<b>PMS</b>	Power Management System
<b>PPE</b>	Personal Protective Equipment
<b>RED</b>	Renewable Energy Directive (EU)
<b>RAM</b>	Reliability, Availability and Maintainability
<b>RINA</b>	Registro Italiano Navale
<b>RLF</b>	Renewable and Low-carbon Fuels
<b>SIMPOS</b>	Simultaneous Operations
<b>SFOC</b>	Specific Fuel Oil Consumption
<b>SOLAS</b>	International Convention for the Safety of Life at Sea (IMO)
<b>SO<sub>x</sub></b>	Sulphur Oxides
<b>TCO</b>	Total Cost of Ownership
<b>TEU</b>	Twenty Foot Equivalent (Container)
<b>TPRD</b>	Thermal Protection Relief Device
<b>TRL</b>	Technology Readiness Level
<b>UI</b>	Unified Interpretation
<b>UR</b>	Unified Requirement
<b>VFD</b>	Variable Frequency Drive
<b>VLCC</b>	Very Large Crude Carrier
<b>VOC</b>	Volatile Organic Compound
<b>Vref</b>	Speed of the vessel at EEDI condition
<b>WAPS</b>	Wind-Assisted Propulsion System

## Appendix II – Methodology for predicting the propulsion fuel consumption savings from WAPS

The objective of this methodology is to estimate the net fuel consumption saved from propulsion when using specific WAPS for a defined vessel route (departure and arrival port), for a given time-period, vessel draft and service speed.

The net fuel savings are calculated by simulations of vessel performance (Monte Carlo) on the *orthodrome* (shortest route distance) between the departure and arrival ports. Vessel performance, i.e., calculation of the vessel's fuel consumption under specific operating and environmental conditions, was conducted by using a fundamental ship-propulsion theory<sup>23</sup>.

The typical ship specific data needed for this analysis include:

- General Arrangement and Capacity Plan
- Hydrostatics tables
- Sea Trial Analysis report
- Model Test Report
- Propeller Plan
- Main Engine Shop Tests
- Port of Departure
- Port of Arrival
- Time-period
- Vessel speed and draft.
- WAPS Geometric Properties
- WAPS Lift and Drag coefficients
- WAPS Power Demand

### Methodology Description

#### **Calm resistance**

The vessel's 'calm resistance', assuming no wind, no waves and a clean hull/propeller, is given by the following:

$$R_{calm} = 0.5 \rho C_T(V_s, T)S$$

Where:

- $V_s$  is the vessel's speed

---

<sup>23</sup> This methodology is applicable to rotor sails, hard sails, soft sails and suction wings. The methodology would need to be modified to capture kite technology as this evolves.

- $T$  is the vessel's draft
- $S$  is the vessel's wetted surface at said draft, and
- $C_T$  is the non-dimensional calm resistance coefficient, encapsulating effects of friction, hull form and wave-making

Calm resistance is typically known through model test reports.

### Added Wave Resistance

The added resistance,  $R_{wave}$ , from waves is to be calculated according to the procedures of the STAWAVE-2 Method. This is an empirical method used to approximate the quadratic-transfer function of the added resistance in waves using main parameters such as ship dimensions and speed. The method includes the added resistance due to ship motions and wave reflections.

Further details of the method are described in ISO 15016, Annex D.

### Wind Resistance

The added resistance due to wind,  $R_{wind}$ , is to be calculated according to the procedures of ISO 15016:2015, Annex C.

$$R_{wind} = 1/2 \cdot \rho \cdot C_{AA}(\theta) A_T V_S^2 - 1/2 \cdot \rho \cdot C_{AA}(0) A_T V_S^2$$

Where  $C_{AA}(\theta)$  is the non-dimensional wind resistance coefficient of the vessel, which is a function of the apparent wind angle.

The following sources for values wind coefficients will be used consistently for all vessels:

- Wind tunnel test
- STA-JIP datasets (in cases where the wind tunnel tests are not available for all vessels)

An installation of a WAPS induces additional drag force, which is calculated as follows:

$$R_{WAPS} = 1/2 \cdot \rho \cdot C_D(R_e, \theta) \cdot A_{WAPS} \cdot V_S^2$$

### Wind-Assisted Propulsion

The total aerodynamic force acting on the WAPS typically can be calculated through the lift and drag coefficient.

Lift is the force perpendicular to the incoming flow. It is defined as,

$$Lift = 1/2 \cdot \rho_{air} \cdot AWS^2 \cdot Area \cdot C_L$$

Drag is the force parallel to the incoming flow. It is defined as,

$$Drag = 1/2 \cdot \rho_{air} \cdot AWS^2 \cdot Area \cdot C_D$$

From this follows that the forward ( $F_A$ ) and side force ( $S_A$ ) are as follows:

$$F_A = Lift \cdot \sin(AWA) - Drag \cdot \cos(AWA)$$

$$S_A = Lift \cdot \cos(AWA) + Drag \cdot \sin(AWA)$$

where  $AWS$  is the apparent wind speed,  $AWA$  is the apparent wind angle,  $Area$  is the projected area of the WAPS and  $C_L$ ,  $C_D$  are the non-dimensional lift and drag coefficients, respectively.

An installation of a WAPS induces an additional drag force, which is calculated as follows:

$$R_{WAPS} = 1/2 \cdot \rho \cdot C_D(R_e, \theta) \cdot A_{WAPS} \cdot V_S^2$$

### Total Force acting on the Vessel and Shaft Power Calculation

The total force acting on the vessel's hull, including the effects of wind, waves and the operation of the WAPS, is calculated as follows.

$$R_T = R_{calm} + R_{wind} + R_{WAPS} + R_{wave} - F_A$$

The delivered power to propel the vessel in this condition is given by:

$$P_D = \frac{R_T \times V_S}{\eta_D}$$

Where  $\eta_D = \eta_R \times \eta_H \times \eta_0$  is the propulsive coefficient:

- $\eta_0$ : propeller open water efficiency, from propeller's open water characteristics
- $\eta_R$ : relative rotative efficiency
- $\eta_H = (1 - t)/(1 - w)$ : hull efficiency,  $t$ : thrust deduction factor,  $w$ : wake fraction

The shaft power is given by the following:

$$P_S = P_D / \eta_S$$

Where  $\eta_S$  is the mechanical efficiency of the shaft system.

### Propulsion Fuel Consumption calculation

The rate of fuel consumption required to propel the vessel under certain conditions is calculated through the main engine specific fuel oil consumption ( $SFOC$ ) curve. The fuel oil consumption rate ( $F\dot{O}C$ ) is calculated by:

$$F\dot{O}C = P_S \times SFOC_{ME}$$

When WAPS is in operation, the propulsion fuel oil consumption rate is calculated as follows:

$$F\dot{O}C = P_S \times SFOC_{ME} + P_{WAPS} \times SFOC_{AE}$$

Where  $P_{WAPS}$  is the power required to operate the WAPS, if any.

### Weather Sampling & Monte Carlo Simulation

To estimate the resulting savings due to WAPS installation on a vessel when sailing on a specified route, at specified speed and draft value, the vessel's propulsion fuel oil consumption rate with and without WAPS should be calculated on the said route and compared.

The Monte Carlo simulation technique provides an approximation of the outcome (fuel oil consumption rate) distribution based on sampling of the input (weather quantities, i.e. significant wave height, wave peak period, etc.), assuming that the input quantities are coming from underlying distributions (see Figure 25) and that the sailing speed and loading condition are fixed. The distribution of weather quantities can be approximated by applying probability density estimation techniques (e.g., Kernel Density Estimation (Epanenchnikov, 1969) on hindcast met-ocean data based on the timeframe of the studied voyage.

Refer to Figure 23 for an example, where the fuel consumption distributions of a vessel with and without WAPS are presented. A direct comparison of the fuel consumption between the vessel with and without WAPS fitted can be made by taking the average values of the corresponding fuel consumption distributions.

## **Results**

The figures below are given as an example result of one simulation:

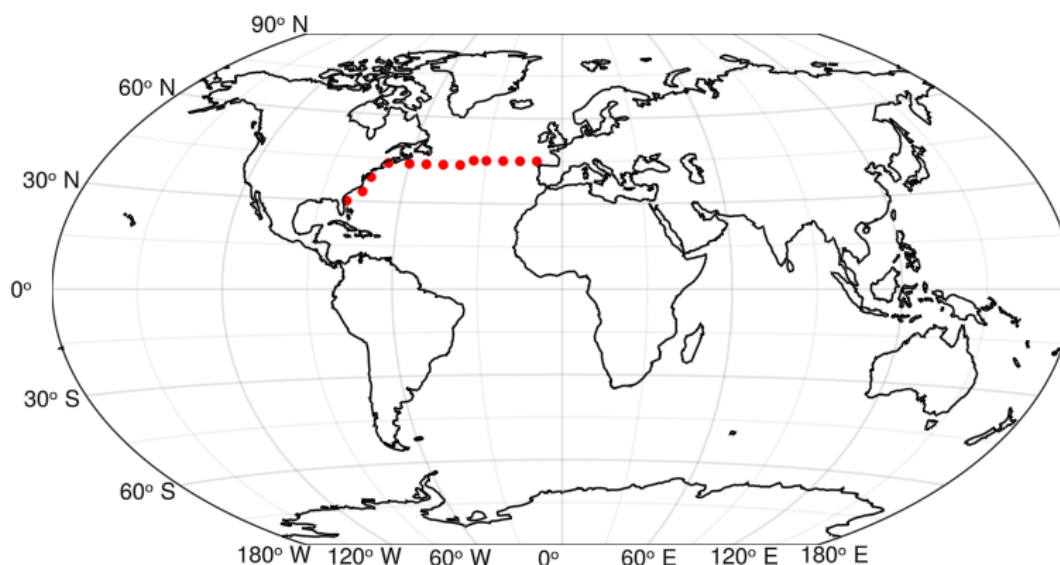

Figure 23. Vessel's route

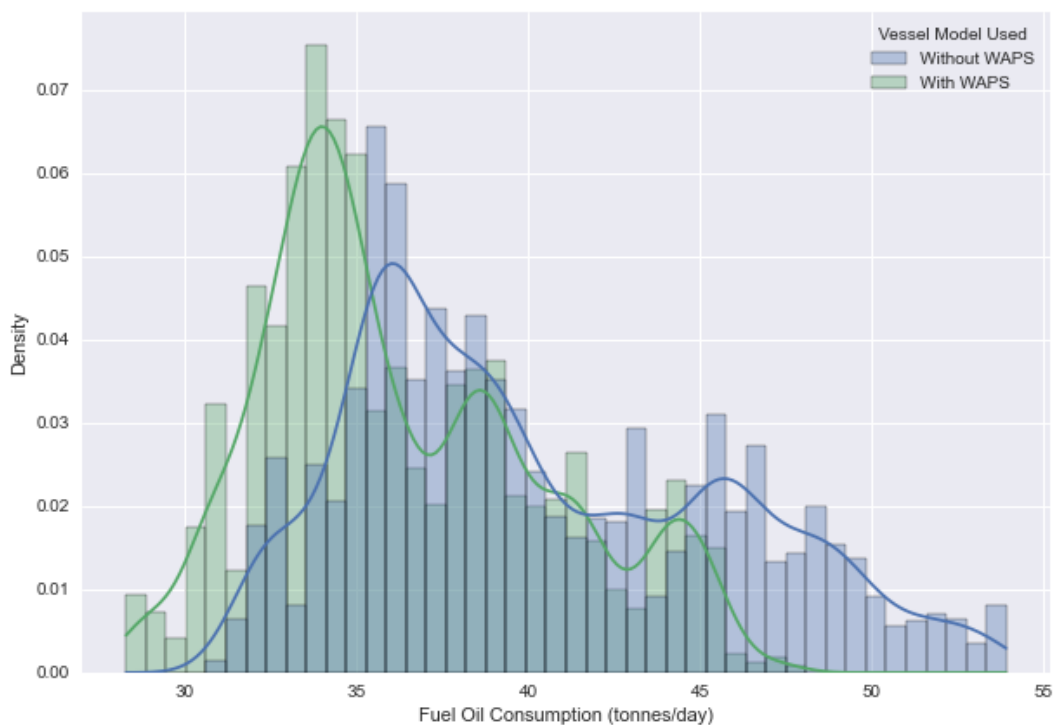

Figure 24. Comparison of propulsion fuel oil consumption distributions, before and after installation of WAPS.



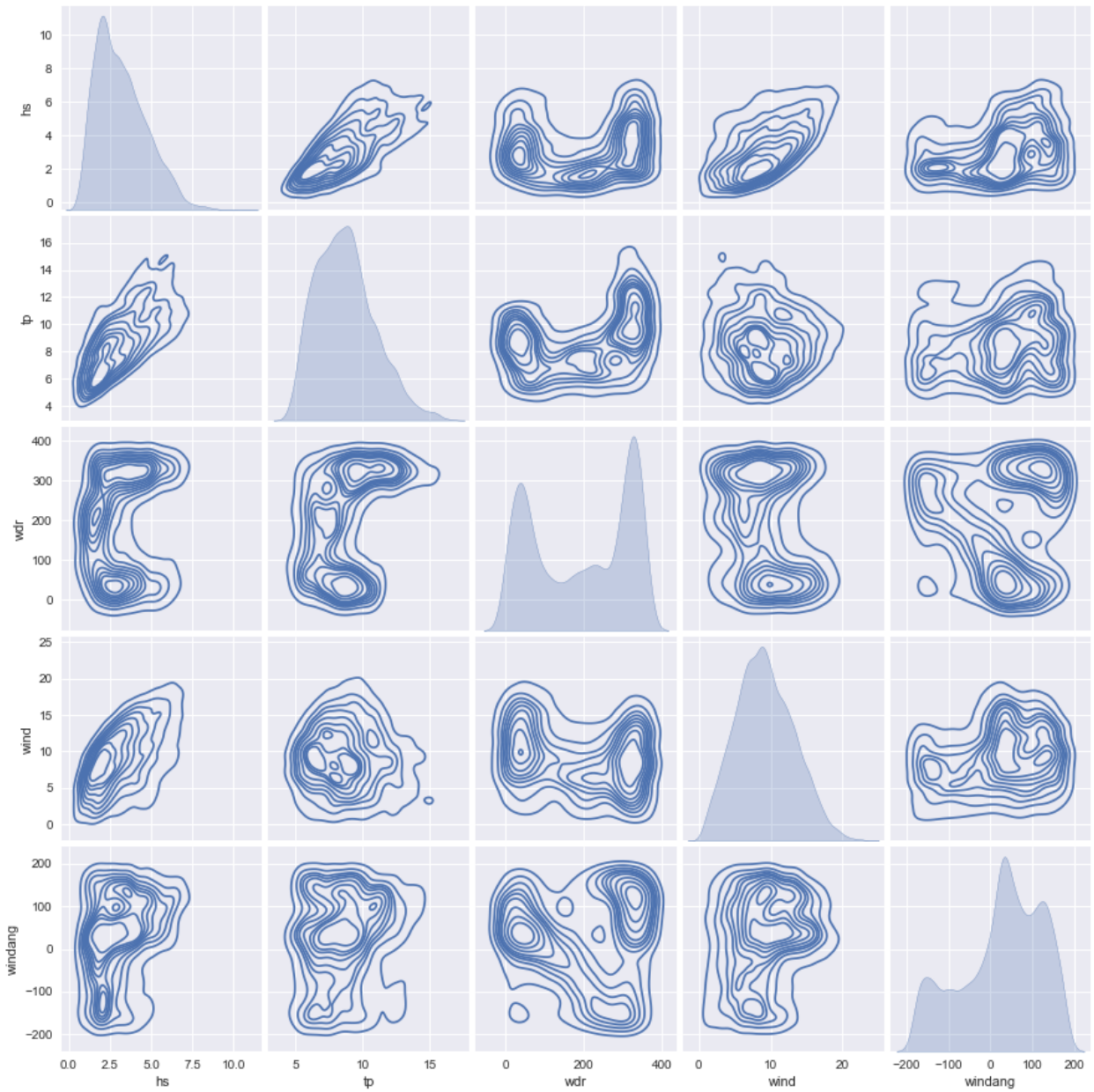

Figure 25. Distribution of encountered weather – pairplots (windang: wind angle, wind: wind speed, wdr: wave direction, hs: significant wave height, tp: wave peak period)

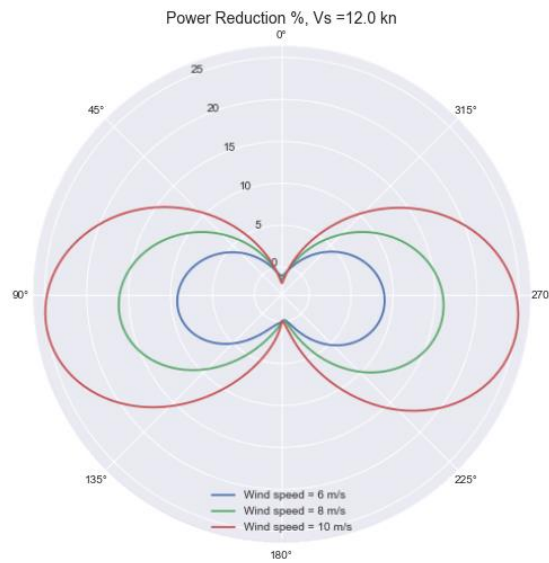

Figure 26. Main engine power reduction. Homocentric circles correspond to constant values of available power reduction.

*Note: The thrust force generated by the rotors is dependent on its revolutions ( $\omega = \frac{2\pi n}{60}$  where  $n$ : rpm). It is assumed that the revolutions are automatically controlled in a way that the resulting thrust force,  $F_A$ , is always maximum under prevailing wind conditions. In Figure 25 the resulting propulsion power savings for different wind speeds are presented as a function of relative wind speed. Since the lift force generated by the rotors is always perpendicular to the apparent wind speed, the power savings are maximised for relative wind angles close to  $\pm 90$  deg.*

## Appendix III – HAZID Risk Matrix

Category	Consequence Severity				
<b>Asset</b>	No shutdown, costs less than \$10,000 to repair	No shutdown, costs less than \$100,000 to repair	Operations shutdown, loss of day rate for 1-7 days and/or repair costs of up to \$1,000,000	Operations shutdown, loss of day rate for 7-28 days and/or repair costs of up to \$10,000,000	Operations shutdown, loss of day rate for more than 28 days and/or repair more than \$10,000,000
<b>Environmental Effects</b>	No lasting effect. Low level impacts on biological or physical environment. Limited damage to minimal area of low significance.	Minor effects on biological or physical environment. Minor short-term damage to small area of limited significance.	Moderate effects on biological or physical environment but not affecting ecosystem function. Moderate short-medium-term widespread impacts e.g., oil spill causing impacts on shoreline.	Serious environmental effects with some impairment of ecosystem function e.g., displacement of species. Relatively widespread medium-long term impacts.	Very serious effects with impairment of ecosystem function. Long term widespread effects on significant environment e.g., unique habitat, national park.
<b>Community/ Government/ Media/ Reputation</b>	Public concern restricted to local complaints. Ongoing scrutiny/attention from regulator.	Minor, adverse local public or media attention and complaints. Significant hardship from regulator. Reputation is adversely affected with a small number of site-focused people.	Attention from media and/or heightened concern by local community. Criticism by NGOs. Significant difficulties in gaining approvals. Environmental credentials moderately affected.	Significant adverse national media/public/NGO attention. May lose licence to operate or not gain approval. Environment/management credentials are significantly tarnished.	Serious public or media outcry (international coverage). Damaging NGO campaign. Licence to operate threatened. Reputation severely tarnished. Share price may be affected.
<b>Injury and Disease</b>	Low level short-term subjective inconvenience or symptoms. No measurable physical effects. No medical treatment required.	Objective but reversible disability/impairment and/or medical treatment, injuries requiring hospitalisation.	Moderate irreversible disability or impairment (<30%) to one or more persons.	Single fatality and/or severe irreversible disability or impairment (>30%) to one or more persons.	Short- or long-term health effects leading to multiple fatalities, or significant irreversible health effects to >50 persons.
	<b>Low</b>	<b>Minor</b>	<b>Moderate</b>	<b>Major</b>	<b>Critical</b>

Category			Consequence Severity				
			1	2	3	4	5
Likelihood	Almost Certain - Occurs 1 or more times a year	E	High	High	Extreme	Extreme	Extreme
	Likely - Occurs once every 1-10 years	D	Moderate	High	High	Extreme	Extreme
	Possible - Occurs once every 10-100 years	C	Low	Moderate	High	Extreme	Extreme
	Unlikely - Occurs once every 100-1,000 years	B	Low	Low	Moderate	High	Extreme
	Rare - Occurs once every 1,000-10,000 years	A	Low	Low	Moderate	High	High
Action Key	Low		No action is required, unless change in circumstances				
	Moderate		No additional controls are required, monitoring is required to ensure no changes in circumstances				
	High		Risk is high and additional control is required to manage risk				
	Extreme		Intolerable risk, mitigation is required				

## Appendix IV – List of Recommendations – Ro-Pax Ferry vessel using Rotor Sails

No.	Action	References
1	Rotor Sail static vs. rotating heeling moment need to be considered for vessel stability. Currently, there are regulations only for static stability and there is no regulation to consider the rotating heeling moment. Regulations are to be developed for this technology.	2.9 Vessel Stability – Wind-Assisted Propulsion System (Rotor Sails) & System Operational Modes
2	Develop vessel operational parameters considering the Rotor Sail design and control-system functions. The issue discussed is higher vessel motion than the design limits may lead to the Rotor Sail performance issues, damage, and vibrations.	2.3 Excessive Vessel Motion – Wind-Assisted Propulsion System (Rotor Sails) & System Operational Modes 2.9 Vessel Stability – Wind-Assisted Propulsion System (Rotor Sails) & System Operational Modes
3	If a vessel operates in a climate with potential for ice accumulation, the potential accumulation on the Rotor Sail system and the impacts need to be investigated.	2.5 Ice accumulation – Wind-Assisted Propulsion System (Rotor Sails) & System Operational Modes
4	Vibration study and analysis to be conducted to understand vibration ranges that may impact components and structure of the Rotor Sail for each vessel installation. Also, consider the vibration impact on passengers and crew comfort.	2.6 Vibration issues – Wind-Assisted Propulsion System (Rotor Sails) & System Operational Modes
5	Conduct fire-risk analysis and evaluate fire-mitigation measures for each vessel installation, considering fire analysis for the Rotor Sail and its components and interfaces with vessel systems such as control, fire detection and the fire-suppression system.	2.8 High temperature of motors (Overheating) – Wind-Assisted Propulsion System (Rotor Sails) & System Operational Modes 2.18 Electrical fire – Wind-Assisted Propulsion System (Rotor Sails) & System Operational Modes
6	Investigate vessel fire-suppression system to verify that, in case of fire in the top of the Rotor Sail (30 m high), the vessel fire-suppression system has enough pressure and hose length to reach the fire.	2.18 Electrical fire – Wind-Assisted Propulsion System (Rotor Sails) & System Operational Modes
7	Noise and vibration analysis to be conducted for passengers and crew safety on a passenger vessel.	2.10 Noise impact on passengers – Wind-Assisted Propulsion System (Rotor Sails) & System Operational Modes
8	Evaluate potential forward visibility issues from the vessel pilot house and radar blind spots if the Rotor Sail is installed onboard a vessel. This is not a significant issue for the ferry since the pilot house is forward and there are two radars in the front and on radar aft of the vessel. SOLAS Chapter V Regulation 22 are to be met.	2.13 Forward Visibility from Pilot House & Radar Blind Spots – Wind-Assisted Propulsion System (Rotor Sails) & System Operational Modes
9	Check whether the installation of the Rotor Sail will affect the equipment number. For ferry, there is no issue identified with changes in the equipment number because the equipment is less than B/4 and therefore not accounted for in the EN calculation.	2.14 Equipment number changes – Wind-Assisted Propulsion System (Rotor Sails) & System Operational Modes
10	Ensure that the information on the wheelhouse is updated to account for the change in air draft.	2.15 Air draft – Wind-Assisted Propulsion System (Rotor Sails) & System Operational Modes
11	Evaluate the Rotor Sail design for drop potentials (loose equipment, vibrations, etc.) and develop prevention and/or mitigation measures to minimise the impact of potential drops on crew and vessel structures.	2.16 Drop Potential (loose equipment from Rotor Sail while rotating) – Wind-Assisted Propulsion System (Rotor Sails) & System Operational Modes 9.3 Dropped Objects during maintenance – Maintenance & Inspection

No.	Action	References
12	Inspection and maintenance procedures to consider the potential for dropped objects and the impact on crew and structure damage. Consider having drop protection practices in place.	2.16 Drop Potential (loose equipment from Rotor Sail while rotating) – Wind-Assisted Propulsion System (Rotor Sails) & System Operational Modes  9.3 Dropped Objects during maintenance – Maintenance & Inspection
13	In addition to visual routine inspection to detect delamination issues in the composite material layers of the Rotor Sail, consider active thermography scanner which can show defects in small scale (centimetres) inside the layers.	2.20 Composite Delamination – Wind-Assisted Propulsion System (Rotor Sails) & System Operational Modes
14	Evaluate the water spray nozzle/hydrant pressure against SOLAS minimum requirements for each vessel type and Rotor Sail installation. For the passenger ship, the minimum pressure at hydrants is 0.4 N/mm <sup>2</sup> .	5.1 Fire Water System – Utilities system
15	Evaluate the firefighting system onboard a vessel with Rotor Sail installation to ensure that there is sufficient coverage (water pressure, flow capacity) to extinguish a fire on top of the Rotor Sail.	5.1 Fire Water System – Utilities system
16	Evaluate the vessel's water drainage capabilities on the deck in case of fire in the Rotor Sail and the fire water system is activated to extinguish the fire. There are drainages in the foundation of the Rotor Sail, however, water drainage from the vessel deck also should be evaluated to avoid vessel stability issues.	5.1 Fire Water System – Utilities system
17	Depending on the vessel location (hot climate), consider the impact to worker comfort and heat injury when conducting maintenance/inspection activities in the Rotor Sail at high temperature, and develop procedures and heat prevention practices (portable fans, water).	9.6 High temperature inside the Rotor Sail – Maintenance & Inspection

## Appendix V – HAZID Register – Ro-Pax Ferry vessel using Rotor Sails

1	Vessel General Arrangement
<p>Scandlines Hybrid Ferry</p> <p>Notes:</p> <ul style="list-style-type: none"> <li>- Ferry is operating 24 hours</li> <li>- Structure is bolted to the vessel structure with double nuts and thread locks</li> <li>- Rotor Sail is located on open deck</li> <li>- Life boats and life crafts are placed at the aft</li> <li>- Egress routes surrounding the Rotor Sail are unprotected, so structural failures may impact/damage egress routes</li> <li>- Loose equipment falling from the Rotor Sail may result in vessel damage or personnel injury on a passenger vessel</li> </ul>	

No.: 1		Vessel General Arrangement								
Item	Deviation	Causes	Consequences	Matrix	Severity	Likelihood	Risk	Safeguards	Recommendations	Comment
1.1	Location of Rotor Sail onboard the vessel	1. No significant issue identified for 30x5 Rotor Sail installation onboard the hybrid ferry vessel.								
1.2	Structural interfaces & strengths	1. Vessel Stability - Wind-Assisted Propulsion System (Rotor Sails) & System Operational Modes (linked from 2.9) 2. Rotor Sail Structural Failure (e.g., foundation or centre structure) - Wind-Assisted Propulsion								



No.: 1		Vessel General Arrangement								
Item	Deviation	Causes	Consequences	Matrix	Severity	Likelihood	Risk	Safeguards	Recommendations	Comment
		System (Rotor Sails) & System Operational Modes (linked from 2.12)								
1.3	Vessel visibility obstructions	1. Forward Visibility from Pilot House & Radar Blind Spots - Wind-Assisted Propulsion System (Rotor Sails) & System Operational Modes (linked from 2.13)								
1.4	Vessel air drafts	1. Air draft - Wind-Assisted Propulsion System (Rotor Sails) & System Operational Modes (linked from 2.15)								
1.5	Escape, Evacuation, and Rescue (EER) measures	1. No signification issue identified for EER measures such as escape routes, lifeboats, etc.								

2	Wind-Assisted Propulsion System (Rotor Sails) & System Operational Modes
<p>Rotor Sail:</p> <ul style="list-style-type: none"> <li>- Height = 30 m</li> <li>- Diameter = 5 m</li> <li>- Weight = approximately 42 tonnes (total weight excluding foundation), less than 20 tonnes (rotor weight)</li> <li>- Additional air draft of vessel = additional 20 m from original height</li> <li>- Rotating part is made of composite materials (glass &amp; carbon fibre), support is made of steel</li> <li>- Max rotational speed: 180 RPM (for 30x5 design)</li> <li>- Design temperature of the rotor sails: 50°C</li> <li>- Ambient environment temperature: -20°C</li> </ul> <p>Main Components (see Rotor Sail general arrangement for more details):</p> <ul style="list-style-type: none"> <li>- Composite rotor</li> <li>- Internal support steel tower</li> <li>- Upper support main bearing &amp; shaft</li> <li>- One Direct Drive Electric Motor and drive for rotation</li> <li>- Lower support rollers</li> <li>- Foundation on Ship's Deck</li> <li>- Electric cabinet</li> <li>- Safety Switch</li> <li>- Cable rack</li> <li>- Ladder</li> <li>- Frequency converter</li> <li>- There is a Tilting Option to reduce air draft ( = ship height) when the vessel is running below bridges or to prevent obstructions.</li> </ul> <p>Rotor Sail Operational Modes (button on the Bridge Control Panel)</p> <ul style="list-style-type: none"> <li>- Automatic (AUTO IDLE): The automation system "listens" to ship's main engines through an integration and decides whether to use Rotor Sails</li> <li>- Sailing (SAILING): The system optimises rotor usage to maximise forward thrust, instead of power savings</li> <li>- Invisible (INV) : The total force from the Rotor Sails, i.e. air drag, is minimised by rotating them at a slow speed.</li> <li>- Idle (IDLE): System is turned to IDLE-mode and Rotor Sails are slowed down to idle speed (typically around 2 RPM)</li> <li>- Off (OFF): System goes to OFF-mode and Rotor Sails are completely stopped.</li> </ul> <p>Note that invisible mode is minimizes the total force of the rotor sails by rotating them at a slow speed of rotation. This mode might be preferred for example when approaching a port in extreme weather.</p> <p>Loads:</p> <ul style="list-style-type: none"> <li>- System has vibration alarms if the loading is high and if specific force limits are reached, then the system RPM is reduced, which reduces the load on the foundation.</li> </ul>	

- See "Rotor Sail Foundation Load Specification" document
- Feasibility Study for each vessel installation will also assess the expected loads for various wind conditions
- Loads calculations follow DNV-ST-0611 rules.
- Pressure measurements to provide feedback on actual conditions
- Various load cases are used in vessel-stability calculations per DNV rules: max lateral forces, fatigue wind loads, extreme wind load, etc.

Additional notes:

- Technology is working based on the principle on Magnus effect
- Rotor Sail uses 1x of the ship's electricity to rotate a cylinder in the wind. Rotating cylinder produces 14x physical thrust.
- Norsepower recommends the vessel keeps the rotor sail on IDLE mode to keep the bearing running; for example, during unloading or loading. The IDLE state is 3-5 RPM which should not affect manoeuvrability or consume much energy.
- Suggest keeping the system around 30 RPM to prevent ice accumulation on top of the Rotor Sail (which is conical shape with some levelled areas exterior)
- During maintenance or inspection, there are E-STOPS to keep the system in fully shutdown state (OFF).
- In rough weather conditions, the customer feedback is the Rotor Sail adds a little stability to the vessel movement in heavy seas.
- Design is not completely watertight.
- System is designed to withstand green-water impact per class requirements.
- Potential ice accumulation near the base tower between the lower support rollers and foundation on the ship's deck.
- To mitigate water ingress & water retention issues, there are drains on both sides of the Rotor Sail steel tower. Watertight design with ventilation opening below the top ledge. A small amount of water will go to the sides and drain through the outer surface of the Rotor Sail.
- There is constant air flow due to ventilation holes in top level and design is not airtight.
- Slip ring is mounted on the main shaft, part of the main bearing system.
- Each vessel will have unique polar diagram and the Rotor Sail system automation system will require input to optimise the rotational speed of the Rotor Sail.
- For wind speeds around 1-25m/s. The system can save fuel starting at 20-degree true wind angle, and when the true wind speed is at 7m/s. Maximum fuel saving is achieved when the true wind angle is about 120 degrees and the true wind speed is 20 m/s or more.
- System control board (bridge control panel) is clear and simplified with 5 operational modes (i.e., IDLE), shutdowns, and E-Stops. The operator also can add input to a preferred thrust value and the system will optimise it in the background. Therefore, the operator will not have to manually put in RPM or looking at polar diagrams.
- Potential blind spots from the pilot house, and vessel can apply for exemptions to be approved by Flag States. (Reference: SOLAS Chapter V, Reg 22 Navigational Bridge Visibility).
- For each installation, Norsepower and vessel owners will conduct feasibility study to understand blind spots and the impact to ship navigation, ship safety.
- Scandlines Hybrid Ferry has a second mast with navigation lights to compensate for blind spots.
- Potential route optimisation service along with Rotor Sails service in the future as a separate online service
- Drains in the foundation in case of condensation or water ingress due to green sea state

No.: 2		Wind-Assisted Propulsion System (Rotor Sails) & System Operational Modes								
Item	Deviation	Causes	Consequences	Matrix	Severity	Likelihood	Risk	Safeguards	Recommendations	Comment
2.1	Ambient temperature too low (below -20°C)	1. Vessel operating in ambient temperature too low (below -20°C)	1. Damage to rotating parts (bearings, motors, etc.)	Asset	3	B	Moderate	1. Rotor Sail System is designed to operate in -20°C temperature and above 2. Temperature monitoring inside the Rotor Sail 3. Current vessel route do not experience ambient temperature below -20°C		- Scandlines operational area is unlikely to experience temperature below -20 degC
2.2	Excessive Wind Speed	1. Excessive Wind Speed	1. Rotor Sail system malfunctions	Asset	1	C	Low	1. Rotor Sail system is designed to withstand extreme wind loads (55m/s wind speed in static condition) 2. Current vessel route do not experience extreme wind loads (below 55m/s wind speed) 3. Wind speed monitoring 4. Rotor Sail system shutdown at high wind speed monitoring setpoint 5. Wind pressures have been considered in the Rotor Sail cylinder design		
			2. High wind pressure on Rotor Sail cylinder,	Asset	2	B	Low			

No.: 2		Wind-Assisted Propulsion System (Rotor Sails) & System Operational Modes								
Item	Deviation	Causes	Consequences	Matrix	Severity	Likelihood	Risk	Safeguards	Recommendations	Comment
			potential asset damage on composite structure							
			3. Vibration inside Rotor Sail cylinder (linked to 2.6)	Asset	2	B	Low			
			4. Rotor Sail Structural Failure (e.g., foundation or centre structure) * (linked to 2.12)	Asset	3	B	Moderate			
			5. Vessel heeling and stability issue (linked to 2.9)	Asset	4	B	High			
2.3	Excessive Vessel Motion	1. Excessive Vessel Motion	1. Rotor Sail performance issues	Asset	1	C	Low	1. Rotor Sail is designed for certain vessel motion limits 2. Vibration monitoring in Rotor Sail system	2. Develop vessel operational parameters considering the Rotor Sail design and control system functions. The issue discussed is higher vessel motion than the design limits may lead to the Rotor Sail performance issues, damage and vibrations.	
			2. Vibration issues	Asset	2	B	Low			
			3. Damage to Rotor Sail bearings or structure	Asset	3	B	Moderate			
			4. Vessel Stability ** (linked to 2.9)							
			5. Rotor Sail Structural Failure (e.g., foundation or centre structure) * (linked to 2.12)							

No.: 2		Wind-Assisted Propulsion System (Rotor Sails) & System Operational Modes								
Item	Deviation	Causes	Consequences	Matrix	Severity	Likelihood	Risk	Safeguards	Recommendations	Comment
2.4	Green water	1. Green water effect during vessel voyage	1. Damage to the Rotor Sail lower bearing	Asset	2	C	Moderate	1. High freeboard height at the Rotor Sail installation location for Ro-Ro and passenger vessels		- for Ro-Ro vessel and passenger vessels, the likelihood of green water effect at the Rotor Sail installation location is very low since the vessel freeboard is high.
			2. Damage to the Rotor Sail structure	Asset	3	B	Moderate			
			3. Shorter life span of the system	Asset	3	B	Moderate			
2.5	Ice accumulation	1. Vessel operating in extreme weather & ice area	1. Ice accumulation on the Rotor Sail rotor top plate	Asset	1	C	Low	1. Rotor Sail is painted with water-repellent paint which reduces water, snow, and ice adhesion 2. Rotor top plate is conical, and with rotating motion, the ice will accumulate and drain out of the rotor bottom surfaces 3. Weather condition monitoring 4. Rotor Sail control system will activate Ice Prevention mode which increases the rotating speed of idle rotor to 30 m/s to prevent ice formation due to centrifugal forces	3. If a vessel operates in a climate with potential for ice accumulation, the potential for ice accumulation on the Rotor Sail system and the impacts to be investigated.	

No.: 2		Wind-Assisted Propulsion System (Rotor Sails) & System Operational Modes								
Item	Deviation	Causes	Consequences	Matrix	Severity	Likelihood	Risk	Safeguards	Recommendations	Comment
			2. Ice accumulation on the deck near the Rotor Sail foundation	Asset	1	C	Low			
		2. Rotor Sails completely stopped for more than 10 minutes (i.e., due to vessel blackout) in icy environment	3. Unable to rotate the Rotor Sail leading to loss of system efficiency	Asset	2	B	Low	5. In areas where ice formation is possible and the Rotor Sail stopped for more than 10 minutes, an alarm message will display on the control panel screen, alerting the operator to check for ice accumulation on the rotor sails before restarting.		
		3. Loss of power supply to Rotor Sail * - System Interfaces (linked from 3.1)								
2.6	Vibration issues	1. Excessive Wind Speed * (linked from 2.2)								- eigen frequencies may cause issues, however lower rotation speed is avoided - vibration issues can be due to high rotation speed, from main engine, propeller induced vibrations, waves
		2. Vibration due to engine	1. Rotor Sail bearing damage	Asset	3	B	Moderate	1. Vibration monitoring in Rotor Sail system (main bearings and crucial components)	4. Vibration study and analysis to be conducted to understand vibration ranges that may impact components and structure	



No.: 2		Wind-Assisted Propulsion System (Rotor Sails) & System Operational Modes								
Item	Deviation	Causes	Consequences	Matrix	Severity	Likelihood	Risk	Safeguards	Recommendations	Comment
								2. During sea trials for vessel installations, vibrations will also be monitored 3. Vibration dampening provided	of the Rotor Sail for each vessel installation. Also consider the vibration impact on passengers and crew comfort.	
			2. Rotor Sail structure damage (fatigue crack, resonance)	Asset	3	B	Moderate			
			3. Rotor Sail foundation loosening	Asset	3	B	Moderate			
			4. Rotor Sail Top Plate damage	Asset	3	B	Moderate			
			5. Rotor Sail Control System components (sensors) damage	Asset	2	B	Low			
			6. Discomfort for ferry passengers and crew	Injury	2	C	Moderate			
			7. Rotor Sail stops functioning leading to loss of fuel saving	Asset	2	B	Low			
		3. Vibration due to higher wind speed	1. Rotor Sail bearing damage	Asset	3	B	Moderate	1. Vibration monitoring in Rotor Sail system (main bearings and crucial components) 2. During sea trials for vessel installations, vibrations will also be monitored 3. Vibration dampening provided	4. Vibration study an analysis to be conducted to understand vibration ranges that may impact components and structure of the Rotor Sail for each vessel installation. Also consider the vibration impact on passengers and crew comfort.	

No.: 2		Wind-Assisted Propulsion System (Rotor Sails) & System Operational Modes								
Item	Deviation	Causes	Consequences	Matrix	Severity	Likelihood	Risk	Safeguards	Recommendations	Comment
			2. Rotor Sail structure damage (fatigue crack, resonance)	Asset	3	B	Moderate			
			3. Rotor Sail foundation loosening	Asset	3	B	Moderate			
			4. Rotor Sail Top Plate damage	Asset	3	B	Moderate			
			5. Rotor Sail Control System components (sensors) damage	Asset	2	B	Low			
			6. Discomfort for ferry passengers and crew	Injury	2	C	Moderate			
			7. Rotor Sail stops functioning leading to loss of fuel saving	Asset	2	B	Low			
		4. Vibration due to propeller motion	1. Rotor Sail bearing damage	Asset	3	B	Moderate	1. Vibration monitoring in Rotor Sail system (main bearings and crucial components) 2. During sea trials for vessel installations, vibrations will also be monitored 3. Vibration dampening provided	4. Vibration study and analysis to be conducted to understand vibration ranges that may impact components and structure of the Rotor Sail for each vessel installation. Also consider the vibration impact on passengers and crew comfort.	
			2. Rotor Sail structure damage (fatigue crack, resonance)	Asset	3	B	Moderate			
			3. Rotor Sail foundation loosening	Asset	3	B	Moderate			
			4. Rotor Sail Top Plate damage	Asset	3	B	Moderate			

No.: 2		Wind-Assisted Propulsion System (Rotor Sails) & System Operational Modes								
Item	Deviation	Causes	Consequences	Matrix	Severity	Likelihood	Risk	Safeguards	Recommendations	Comment
			5. Rotor Sail Control System components (sensors) damage	Asset	2	B	Low			
			6. Discomfort for ferry passengers and crew	Injury	2	C	Moderate			
			7. Rotor Sail stops functioning leading to loss of fuel saving	Asset	2	B	Low			
		5. Vibration due to rotor motion (in Rotor Sail)	1. Rotor Sail bearing damage	Asset	3	B	Moderate	1. Vibration monitoring in Rotor Sail system (main bearings and crucial components) 2. During sea trials for vessel installations, vibrations will also be monitored 3. Vibration dampening provided 4. Rotor is balanced to minimise vibration	4. Vibration study and analysis to be conducted to understand vibration ranges that may impact components and structure of the Rotor Sail for each vessel installation. Also consider the vibration impact on passengers and crew comfort.	
			2. Rotor Sail structure damage (fatigue crack, resonance)	Asset	3	B	Moderate			
			3. Rotor Sail foundation loosening	Asset	3	B	Moderate			
			4. Rotor Sail Top Plate damage	Asset	3	B	Moderate			
			5. Rotor Sail Control System components (sensors) damage	Asset	2	B	Low			
			6. Discomfort for ferry passengers and crew	Injury	2	C	Moderate			

No.: 2		Wind-Assisted Propulsion System (Rotor Sails) & System Operational Modes								
Item	Deviation	Causes	Consequences	Matrix	Severity	Likelihood	Risk	Safeguards	Recommendations	Comment
			7. Rotor Sail stops functioning leading to loss of fuel saving	Asset	2	B	Low			
2.7	High Main bearing temperature	1. High rotation speed	1. High main bearing temperature in the Rotor Sail	Asset	2	C	Moderate	1. Bearing temperature monitoring 2. High bearing temperature will initiate system shutdown 3. Bearing lubrication (grease) is used 4. Regular inspection & maintenance procedures include checks on bearings and related components for damage 5. Main bearing life is around 25 years and 90-95% of run time		
		2. Bearing damage (wear and tear)	1. High main bearing temperature in the Rotor Sail	Asset	2	C	Moderate	1. Bearing temperature monitoring 2. High bearing temperature will initiate system shutdown 3. Bearing lubrication (grease) is used 4. Regular inspection & maintenance procedures include checks on bearings and related components for damage 5. Main bearing life is around 25 years and 90-95% of run time		

No.: 2		Wind-Assisted Propulsion System (Rotor Sails) & System Operational Modes								
Item	Deviation	Causes	Consequences	Matrix	Severity	Likelihood	Risk	Safeguards	Recommendations	Comment
		3. Inadequate bearing lubrication	1. High main bearing temperature in the Rotor Sail	Asset	2	C	Moderate	1. Bearing temperature monitoring 2. High bearing temperature will initiate system shutdown 3. Bearing lubrication (grease) is used 4. Regular inspection & maintenance procedures include checks on bearings and related components for damage 5. Main bearing life is around 25 years and 90-95% of run time		
		4. Improper bearing sizing	1. High main bearing temperature in the Rotor Sail	Asset	2	C	Moderate	1. Bearing temperature monitoring 2. High bearing temperature will initiate system shutdown 3. Bearing lubrication (grease) is used 4. Regular inspection & maintenance procedures include checks on bearings and related components for damage 5. Main bearing life is around 25 years and 90-95% of run time		
			2. Main bearing jamming, system malfunctions and loss of fuel savings	Asset	3	B	Moderate			

No.: 2		Wind-Assisted Propulsion System (Rotor Sails) & System Operational Modes								
Item	Deviation	Causes	Consequences	Matrix	Severity	Likelihood	Risk	Safeguards	Recommendations	Comment
2.8	High temperature of motors (Overheating)	1. Motor overloading	1. High temperature of the motors (overheating)	Asset	2	C	Moderate	1. Motor temperature monitoring 2. Amperage monitoring 3. Motor overload protection 4. Cooling fan with separate motors 5. Smoke and heat monitoring to detect fire inside Rotor Sail system, initiate alarm for operator to manually shutdown the Rotor Sail system	5. Conduct fire risk analysis and evaluate fire mitigation measures for each vessel installation, considering fire analysis for the Rotor Sail and its components and interfaces with vessel systems such as vessel control, vessel fire detection, and vessel fire suppression system.	
			2. Motor damage	Asset	3	B	Moderate			
			3. Rotor Sail system malfunctions and loss of fuel savings	Asset	3	B	Moderate			
			4. Electrical fire * (linked to 2.18)							
2.9	Vessel Stability	1. Excessive Wind Speed (linked from 2.2)	1. Vessel stability issues	Asset	4	B	High		1. Rotor Sail static vs. rotating heeling moment need to be considered for vessel stability. Currently, there are regulations only for static stability and there is no regulation to consider the rotating heeling moment. Regulations are to be developed for this technology.	- algorithm also calculates heeling moment and stability calculations during vessel feasibility study. Heel safety limits for Ro-ro or passenger carrier. - RECOMMENDATION: heeling tanks adjustment/verifications considerations from stability and feasibility

No.: 2		Wind-Assisted Propulsion System (Rotor Sails) & System Operational Modes								
Item	Deviation	Causes	Consequences	Matrix	Severity	Likelihood	Risk	Safeguards	Recommendations	Comment
									2. Develop vessel operational parameters considering the Rotor Sail design and control system functions. The issue discussed is higher vessel motion than the design limits may lead to the Rotor Sail performance issues, damage and vibrations.	study - based on current customer feedback, having the Rotor Sail can have damping effect and improve the vessel stability (reduce acceleration and roll amplitude)  - comment: for stability criteria, normally the lateral or profile area is used to calculate wind heel moments, but this is static. With a rotor sail, the moment can be larger if the rotor is spinning. So, a choice needs to be made (for consistent interpretation by all Administrations and IACS members) whether the static moment or a larger heeling moment (and this is a discussion also relevant for whether something is stowed)
			2. Reduced rotational speed and loss of fuel saving	Asset	3	B	Moderate			
		2. Excessive Vessel Motion (linked from 2.3)	1. Vessel stability issues	Asset	4	B	High		1. Rotor Sail static vs. rotating heeling moment	



No.: 2		Wind-Assisted Propulsion System (Rotor Sails) & System Operational Modes								
Item	Deviation	Causes	Consequences	Matrix	Severity	Likelihood	Risk	Safeguards	Recommendations	Comment
		<p>Comment: Based on current feedback from customers, the Rotor Sail dampens the vessel roll motion and increases heel.</p> <p>Vessel motion limits are determined by bearing accelerations.</p>							<p>need to be considered for vessel stability. Currently, there are regulations only for static stability and there is no regulation to consider the rotating heeling moment. Regulations are to be developed for this technology.</p> <p>2. Develop vessel operational parameters considering the Rotor Sail design and control system functions. The issue discussed is higher vessel motion than the design limits may lead to the Rotor Sail performance issues, damage, and vibrations.</p>	
			2. Reduced rotational speed and loss of fuel saving	Asset	3	B	Moderate			
2.10	Noise impact on passengers	1. Noise and vibration	1. Crew and passenger discomfort	Injury	2	C	Moderate	1. Testing is conducted after each Rotor Sail fabrication to evaluate the noise and vibration levels	7. Noise and vibration analysis to be conducted for passengers and crew safety on a passenger vessel.	- for passenger vessels, in addition to IMO regulations, the owner may select a comfort class for retrofit and new build vessels and evaluate the design, including the expected noise levels

No.: 2		Wind-Assisted Propulsion System (Rotor Sails) & System Operational Modes								
Item	Deviation	Causes	Consequences	Matrix	Severity	Likelihood	Risk	Safeguards	Recommendations	Comment
										impact on crew and passengers.
2.11	Water Condensation inside the Rotor Sail	1. Moisture in the air	1. Condensation on cold surfaces inside Rotor Sail	Asset	1	C	Low	1. Drain collections at the lower part of the Rotor Sail which discharges to the deck through steel foundation 2. When the Rotor Sail is rotating, the increased air flow inside will help prevent water condensation on cold surfaces 3. Rotor Sail is painted with water-repellent paint which reduces water, snow and ice adhesion 4. Equipment are rated IP-56 to protect against condensation and moisture		
			2. Corrosion on Rotor Sail components due to water condensation	Asset	2	B	Low			
			3. Electrical short-circuiting	Asset	3	B	Moderate			
2.12	Rotor Sail Structural Failure (e.g., foundation or centre structure)	1. Excessive Wind Speed (linked from 2.2)								- vessel is very well subdivided

No.: 2		Wind-Assisted Propulsion System (Rotor Sails) & System Operational Modes								
Item	Deviation	Causes	Consequences	Matrix	Severity	Likelihood	Risk	Safeguards	Recommendations	Comment
		2. Excessive Vessel Motion (linked from 2.3)								
		3. Complete failure of Rotor Sail	1. Rotor Sail structure falling on deck and deck damage	Asset	3	B	Moderate	1. Structure design to meet classification society rules and all expected static and dynamic loads are considered in the design 2. Active monitoring (e.g., vibration, loads, fire, heat) in Rotor Sail system 3. Inspection & Maintenance Program 4. MES Stations (2) and Lifeboats (2) are designed per SOLAS minimum requirements (125% for lifeboats and life rafts) 5. Scandlines ferry is hybrid with redundant power (battery power available to provide emergency power) 6. Rotor Sail area is restricted for passengers		
			2. Potential human injury	Injury	2	B	Low			
			3. Lifeboat or MES Station damage on one side of the vessel	Asset	3	B	Moderate			

No.: 2		Wind-Assisted Propulsion System (Rotor Sails) & System Operational Modes								
Item	Deviation	Causes	Consequences	Matrix	Severity	Likelihood	Risk	Safeguards	Recommendations	Comment
			4. Structural damage to the vessel	Asset	3	B	Moderate			
			5. Rotor Sail collapse aft and blocking the funnel, engine not available (worst case failure scenario)	Asset	4	B	High			
2.13	Forward Visibility from Pilot House & Radar Blind Spots	1. General Recommendations							8. Evaluate potential forward visibility issues from the vessel pilot house and radar blind spots if the Rotor Sail is installed onboard a vessel. This is not a significant issue for the Ferry since the pilot house is forward and there are two radars in the front and one radar aft of the vessel. SOLAS Chapter V Regulation 22 are to be met.	- For Scandlines Ferry, the pilot house is forward and there are two radars in the front and one radar aft of the vessel.
2.14	Equipment number changes	1. General Recommendation							9. Check whether the Rotor Sail installation will affect the equipment number. For Ferry, there is no issue identified with changes in the equipment number because the equipment is less than B/4 and therefore not considered in the equipment number calculation.	

No.: 2		Wind-Assisted Propulsion System (Rotor Sails) & System Operational Modes								
Item	Deviation	Causes	Consequences	Matrix	Severity	Likelihood	Risk	Safeguards	Recommendations	Comment
2.15	Air draft	1. Increase in air draft (For the 30x5 Rotor Sail, the change in air draft is 20 m)	1. Hitting overhead obstacles, gantry cranes in port, bridges resulting in Rotor Sail damage	Asset	2	C	Moderate	1. Maximum air draft has been verified and for the specific vessel route, this is not an issue.	10. Ensure that the information on the wheelhouse is updated to account for the change in air draft.	
2.16	Drop Potential (loose equipment from Rotor Sail while rotating)	1. Part of Rotor Sail fails (e.g., cap, equipment can be bolts, lights, small components)	1. Human Injury to Crew	Injury	4	B	High	1. Rotor Sail area is restricted for passengers 2. Inspection and Maintenance Safe Practices 3. Rotor Sail design is drop proof, with measures (double knots and thread locking) to prevent drop potentials	11. Evaluate the Rotor Sail design for drop potentials (loose equipment, vibrations, etc.) and develop prevention and/or mitigation measures to minimise the impact of potential drops on crew and vessel structures.	
		2. Vibration leading to equipment loosening	1. Human Injury to Crew	Injury	4	B	High	1. Rotor Sail area is restricted for passengers 3. Rotor Sail design is drop proof, with measures (double knots and thread locking) to prevent drop potentials 4. Vibration monitoring in Rotor Sail system (main bearings and crucial components) 5. Testing is conducted after each Rotor Sail fabrication to evaluate the noise and vibration levels	11. Evaluate the Rotor Sail design for drop potentials (loose equipment, vibrations, etc.) and develop prevention and/or mitigation measures to minimise the impact of potential drops on crew and vessel structures.	
		3. Improper maintenance or installation	1. Human Injury to Crew	Injury	4	B	High	1. Rotor Sail area is restricted for passengers	11. Evaluate the Rotor Sail design for drop potentials	

No.: 2		Wind-Assisted Propulsion System (Rotor Sails) & System Operational Modes								
Item	Deviation	Causes	Consequences	Matrix	Severity	Likelihood	Risk	Safeguards	Recommendations	Comment
								3. Rotor Sail design is drop proof, with measures (double knots and thread locking) to prevent drop potentials 5. Testing is conducted after each rotor sail fabrication to evaluate the noise and vibration levels	(loose equipment, vibrations, etc.) and develop prevention and/or mitigation measures to minimise the impact of potential drops on crew and vessel structures. 12. Inspection and maintenance procedures to consider drop potential and the impact on crew and structure damage. Consider having drop protection practices in place.	
		4. Workers working at height not following safe drop practices (during inspection, maintenance)	1. Human Injury to Crew	Injury	4	B	High	6. Workers wearing Personnel Protection Equipment (PPE) in the drop zone while working 7. Workers working at height will have drop proof instruments/tools available (tethered to the worker or structure so nothing can fall)	11. Evaluate the Rotor Sail design for drop potentials (loose equipment, vibrations, etc.) and develop prevention and/or mitigation measures to minimise the impact of potential drops on crew and vessel structures. 12. Inspection and maintenance procedures to consider drop potential and the impact on crew and structure damage. Consider having drop protection practices in place.	

No.: 2		Wind-Assisted Propulsion System (Rotor Sails) & System Operational Modes								
Item	Deviation	Causes	Consequences	Matrix	Severity	Likelihood	Risk	Safeguards	Recommendations	Comment
2.17	High roller bearing temperature	1. High rotation speed	1. Roller surface wear, leading to potential vibration & noise issues	Asset	2	B	Low	1. Each roller temperature monitoring (14 rollers per Rotor Sail cylinder) 2. High roller bearing temperature will initiate system shutdown 3. Bearing lubrication (grease) is used 4. Regular inspection and maintenance procedures include checks on bearings and related components for damage 5. Lower bearing is designed to be easily replaceable and spares are carried 6. Design of rollers design follows n+2 redundancy principles		
			2. High roller bearing temperature in the Rotor Sail	Asset	2	B	Low			
			3. Roller bearing jamming, system malfunctions and loss of fuel savings	Asset	3	B	Moderate			
		2. Bearing damage (wear and tear)	2. High roller bearing temperature in the Rotor Sail	Asset	2	B	Low	1. Each roller temperature monitoring (14 rollers per Rotor Sail cylinder)		



No.: 2		Wind-Assisted Propulsion System (Rotor Sails) & System Operational Modes								
Item	Deviation	Causes	Consequences	Matrix	Severity	Likelihood	Risk	Safeguards	Recommendations	Comment
								2. High roller bearing temperature will initiate system shutdown 3. Bearing lubrication (grease) is used 4. Regular inspection and maintenance procedures include checks on bearings and related components for damage 5. Lower bearing is designed to be easily replaceable and spares are carried 6. Design of rollers follows n+2 redundancy principles		
			3. Roller bearing jamming, system malfunctions and loss of fuel savings	Asset	3	B	Moderate			
		3. Inadequate bearing lubrication	2. High roller bearing temperature in the Rotor Sail	Asset	2	B	Low	1. Each roller temperature monitoring (14 rollers per Rotor Sail cylinder) 2. High roller bearing temperature will initiate system shutdown 3. Bearing lubrication (grease) is used 4. Regular inspection & maintenance procedures include checks on		

No.: 2		Wind-Assisted Propulsion System (Rotor Sails) & System Operational Modes								
Item	Deviation	Causes	Consequences	Matrix	Severity	Likelihood	Risk	Safeguards	Recommendations	Comment
								bearings and related components for damage 5. Lower bearing is designed to be easily replaceable and spares are carried 6. Design of rollers follows n+2 redundancy principles		
			3. Roller bearing jamming, system malfunctions and loss of fuel savings	Asset	3	B	Moderate			
		4. Improper bearing sizing	2. High roller bearing temperature in the Rotor Sail	Asset	2	B	Low	1. Each roller temperature monitoring (14 rollers per Rotor Sail cylinder) 2. High roller bearing temperature will initiate system shutdown 3. Bearing lubrication (grease) is used 4. Regular inspection & maintenance procedures include checks on bearings and related components for damage 5. Lower bearing is designed to be easily replaceable and spares are carried 6. Design of rollers follows n+2 redundancy principles		

No.: 2		Wind-Assisted Propulsion System (Rotor Sails) & System Operational Modes								
Item	Deviation	Causes	Consequences	Matrix	Severity	Likelihood	Risk	Safeguards	Recommendations	Comment
			3. Roller bearing jamming, system malfunctions and loss of fuel savings	Asset	3	B	Moderate			
2.18	Electrical fire	1. High temperature of motors (Overheating) * (linked from 2.8)	1. Electrical fire	Asset	3	B	Moderate	1. Smoke and heat monitoring to detect fire inside Rotor Sail system, initiate alarm for operator to manually shutdown the system by E-STOPS or turning off 3. Fire resistant/intumescent coating on exterior surfaces of the Rotor Sail 4. Electrical system is designed such that components that have a higher chance of catching fire is located inside the steel cylinder (some fire barrier)	5. Conduct fire risk analysis and evaluate fire mitigation measures for each vessel installation, considering fire analysis for the Rotor Sail and its components and interfaces with vessel systems such as vessel control, vessel fire detection and vessel fire-suppression system. 6. Investigate existing vessel fire suppression system to verify that, in case of fire in the top of the Rotor Sail (30 m high), the vessel fire suppression system has enough pressure and hose length to reach the fire.	
			2. Damage to Rotor Sail Electrical system	Asset	2	B	Low			
			3. Rotor Sail system malfunctions and loss of fuel savings	Asset	3	B	Moderate			
		2. Short-circuit	1. Electrical fire	Asset	3	B	Moderate	1. Smoke and heat monitoring to detect fire inside Rotor Sail system, initiate alarm for operator to manually	5. Conduct fire risk analysis and evaluate fire mitigation measures for each vessel installation, considering fire analysis	

No.: 2		Wind-Assisted Propulsion System (Rotor Sails) & System Operational Modes								
Item	Deviation	Causes	Consequences	Matrix	Severity	Likelihood	Risk	Safeguards	Recommendations	Comment
								shutdown the system by E-STOPS or turning off 2. Short-circuit protection 3. Fire resistant/intumescent coating on exterior surfaces of the Rotor Sail	for the Rotor Sail and its components and interfaces with vessel systems such as vessel control, vessel fire detection, and vessel fire suppression system. 6. Investigate vessel fire-suppression system to verify that, in case of fire in the top of the Rotor Sail (3-m high), the vessel fire-suppression system has enough pressure and hose length to reach the fire.	
			2. Damage to Rotor Sail Electrical system	Asset	2	B	Low			
			3. Rotor Sail system malfunctions and loss of fuel savings	Asset	3	B	Moderate			
2.19	Corrosion	1. Humidity	1. Material degradation due to corrosion	Asset	2	C	Moderate	1. Rotor Sail is painted with corrosion resistant coating on steel structures 2. Inspection and maintenance program		
			2. Equipment failure and damage	Asset	3	B	Moderate			
		2. Marine Saline Environment	1. Material degradation due to corrosion	Asset	2	C	Moderate	1. Rotor Sail is painted with corrosion resistant coating on steel structures		

No.: 2		Wind-Assisted Propulsion System (Rotor Sails) & System Operational Modes								
Item	Deviation	Causes	Consequences	Matrix	Severity	Likelihood	Risk	Safeguards	Recommendations	Comment
								2. Inspection and maintenance program		
			2. Equipment failure and damage	Asset	3	B	Moderate			
2.20	Composite Delamination	1. Manufacturing defect, cracks	1. Composite Delamination	Asset	2	C	Moderate	1. Inspection and maintenance program 2. Composite layers are designed with safety criteria and margins 3. Quality assurance and quality control (QA/QC) for manufacturing process	13. In addition to visual routine inspection to detect delamination issues in the composite material layers of the Rotor Sail, consider active thermography scanner which can show defects in small scale (centimetres) inside the layers.	- The Rotor Sail is made of composite material in multi-layers of glass and carbon fibre. - Delamination is a common failure mode in composite materials and steel. - Delamination is the separation of layers due to repeated stresses, impacts, or defects.
			2. Equipment failure	Asset	3	B	Moderate			

3	System Interfaces
<p>Vessel &amp; Interfaces</p> <ul style="list-style-type: none"> <li>- Scandlines is a hybrid ferry with one Rotor Sail to provide wind-assisted propulsion</li> <li>- Rotor Sail is installed on fixed foundations on the vessel's open deck</li> <li>- The vessel's electrical grid provides the power to rotate the Rotor Sail</li> <li>- Process and automation control unit- controls each Rotor Sail for operational, safety, and emergency conditions. It optimises the thrust produced by the Rotor Sail based on surrounding factors such as wind speed, direction, sensor information, operator inputs.</li> <li>- Sensors (wind, GPS, and weather station sensors) - installed on each Rotor Sail and connected to the control system to provide control and monitoring.</li> <li>- Bridge control Panel shows real-time status of the Rotor Sail and allow the vessel bridge crew to control the sail.</li>   <li>- Rotor-specific fire alarm detectors are integrated to the vessel's fire-alarm system and a vessel fire alarm will trigger automatic shutdown of the Rotor Sail</li> <li>- emergency lights and flight obstruction lights in the Rotor Sail are connected to the vessel's UPS</li> <li>- the motor for Rotor Sail and main instrumentations take power from the main vessel switchboard.</li> </ul>	

No.: 3		System Interfaces								
Item	Deviation	Causes	Consequences	Matrix	Severity	Likelihood	Risk	Safeguards	Recommendations	Comment
3.1	Loss of power supply to Rotor Sail	1. Loss of power supply (vessel main switchboard 440V) to Rotor Sail	1. Rotor Sail stops	Asset	1	C	Low	1. Crew can manually rotate the bearings to prevent damage		
			2. Potential ice accumulation if the Rotor Sail stops for an extended period ((24 hr) (linked to 2.5)	Asset	3	B	Moderate			
			3. Potential bearing damage if the Rotor Sail stops for an extended period (24 hours)	Asset	3	B	Moderate			

No.: 3		System Interfaces								
Item	Deviation	Causes	Consequences	Matrix	Severity	Likelihood	Risk	Safeguards	Recommendations	Comment
		2. Loss of 24V power supply to Rotor Sail instrumentations	1. Rotor Sail stops	Asset	1	C	Low			



4	Rotor Sails Control/Automation System
<p>Fire Safety:</p> <ul style="list-style-type: none"> <li>- Fire-resistant coating</li> <li>- Rotating part is made of composite materials (glass and carbon fibre), Support is made of steel</li> <li>- Operational temperature (normal conditions) is 50°C</li> <li>- Smoke and Heat detectors inside the system, activation will shut down the system to prevent fire propagation.</li> <li>- Fire suppression system can also be connected to the vessel fire suppression system or water lines in case of any fire (i.e., electrical fire, lube oil fire).</li> </ul> <p>Safety:</p> <ul style="list-style-type: none"> <li>- Flight Obstruction Lights on top of the hat plate</li> <li>- Flood lights to provide visibility to Rotor Sail during nighttime, in case of helicopter approaching</li> <li>- Helicopter approach toggle switch (on the bridge) to automatically stop the Rotor Sail and turn on the flight-obstruction light.</li> <li>- Fall prevention measures for inspection/maintenance issues.</li> <li>- Lightning protection is standard for all units</li> </ul> <p>Controls System:</p> <ul style="list-style-type: none"> <li>- Based on the wind speed and direction, the Rotor Sail rotational direction and speed (RPM) will change automatically.</li> <li>- System creates a forward thrust in 90-degree angle to the relative wind</li> <li>- Normally controlled from the bridge control panel</li> <li>- Conditional monitoring (vibration on bearings, bearing temperatures, grounding) and feedback from Variable Frequency Drive (VFD) and pressure measurement systems (thrusts and forces).</li> <li>- Weather stations: ambient weather sensors and wind direction and speed sensors</li> <li>- Sensors are in the main bearing unit: vibration and temperature sensors inside the steel tower that are accessible with fall prevention measures available.</li> <li>- Additional control features:           <ul style="list-style-type: none"> <li>- 2x internal E-STOP buttons and 1x external E-STOP button (for emergency and service access)</li> <li>- Main switch for both three-phase main power and on-phase aux power</li> <li>- Helicopter approach toggle switch to turn on flight obstruction light</li> <li>- 2x fire alarm push button</li> </ul> </li> </ul> <p>- Rotation speed can be adjusted manually by operator and adjust VFD directly to adjust the RPM.</p>	

No.: 4		Rotor Sails Control/Automation System								
Item	Deviation	Causes	Consequences	Matrix	Severity	Likelihood	Risk	Safeguards	Recommendations	Comment
4.1	Control System malfunctions during mooring and in AUTO IDLE mode	1. Control instrument malfunctions in AUTO IDLE mode during mooring in a narrow channel	1. Rotor Sail rotating speed is higher than needed due to control system failure	Asset	1	C	Low	1. Redundancy in the control instrumentations to keep Rotor Sail functioning 2. Visual inspection by the crew 3. Remote support can bypass instrumentation 4. Rotor Sail Control System also takes inputs from the vessel wind sensors to check instrumentation readings 5. Control System has been validated and tested to identify various malfunctions		- overspeeding of rotor due to sensors issues, etc. - AUTO IDLE mode is when the vessel listens to the ship's engines, interfaces, and decides to use the Rotor Sail or not. The Rotor Sail then automatically set to rotate in a speed that will produce thrusts and result in net fuel savings. - IDLE mode is when the system slowed down to around 2 RPM in normal weather, and 30 RPM in icing conditions. In IDLE mode, there is no risk.
			2. Higher vibration from the system	Asset	2	B	Low			
			3. Damage to the vessel mooring line if Rotor Sail is rotating at higher speed in AUTO IDLE mode (more thrust than expected)	Asset	3	B	Moderate			
			4. Vessel collision if it is narrow channels	Overall	S4-Major	LB-Unlikely	High			
4.2	Other Operational Modes	1. There is no other issues identified with the control/automation								

No.: 4		Rotor Sails Control/Automation System								
Item	Deviation	Causes	Consequences	Matrix	Severity	Likelihood	Risk	Safeguards	Recommendations	Comment
		system when the Rotor Sail is in other operational modes: SAILING, IDLE Mode, INVISIBLE, and OFF. Comment: - When the Rotor Sail is in OFF mode, there is timing and warning alerting the operators to contact the Rotor Sail manufacturer and prevent any equipment damage issues due to long term off mode (e.g., ice accumulation, bearing damage).								

5	Utilities system
<p>Utilities System inside the Rotor Sail:</p> <ul style="list-style-type: none"> <li>- For Scandlines, the Rotor Sail system has two water spray nozzles inside the Rotor Sail to provide coverage for the cabinet (bottom) and motor and bearing (top)</li> <li>- Fire water system supply valve is operated from the control manual.</li> <li>- In case a fire is detected, the main power source is automatically disconnected from the ship side (440V, 220V, 24V)</li> <li>- SOLAS requirement for minimum pressure at water hydrants/spray nozzles is 0.4 N/mm<sup>2</sup> for passenger ship system</li> </ul>	

No.: 5		Utilities system								
Item	Deviation	Causes	Consequences	Matrix	Severity	Likelihood	Risk	Safeguards	Recommendations	Comment
5.1	Fire Water System	1. Not enough pressure at the spray nozzle	1. Unable to extinguish fire	Asset	2	B	Low	3. Water Spray on the surface of composite layers 4. Fire resistant/intumescent coating on exterior surfaces of the Rotor Sail 5. Drainages in the foundation of the Rotor Sail such that water inside the steel structures will drain out through gratings	14. Evaluate the water spray nozzle/hydrant pressure considering SOLAS minimum requirements for each vessel type and Rotor Sail installation. For the passenger ship, the minimum pressure at hydrants is 0.4 N/mm <sup>2</sup> . 15. Evaluate the firefighting system onboard a vessel with Rotor Sail installation to ensure that there is sufficient coverage (water pressure, flow capacity) to extinguish a fire on top of the Rotor Sail. 16. Evaluate the vessel's ability to drain water on the deck in case of fire in the Rotor Sail and the fire	

No.: 5		Utilities system								
Item	Deviation	Causes	Consequences	Matrix	Severity	Likelihood	Risk	Safeguards	Recommendations	Comment
									water system is activated to extinguish the fire. There are drains in the foundation of the Rotor Sail, however, water drainage from the vessel deck also should be evaluated to avoid vessel stability issues.	
			2. Short-circuiting (due to water spray on electrical equipment)	Asset	3	B	Moderate			
			4. Water accumulation at the bottom due to firewater system activation	Asset	3	B	Moderate			
		2. Fire inside Rotor Sail (in motor or bearings)	2. Short-circuiting (due to water spray on electrical equipment)	Asset	3	B	Moderate	1. Electrical power supply is automatically isolated from ship power supply upon detection of fire in the Rotor Sail 2. Smoke and heat monitoring to detect fire inside Rotor Sail system, initiate alarm for operator to manually shutdown the system by E-STOPS or turning off 3. Water Spray on the surface of composite layers 4. Fire resistant/intumescent coating on	14. Evaluate the water spray nozzle/hydrant pressure considering SOLAS minimum requirements for each vessel type and Rotor Sail installation. For the passenger ship, the minimum pressure at hydrants is 0.4 N/mm <sup>2</sup> .	

No.: 5		Utilities system								
Item	Deviation	Causes	Consequences	Matrix	Severity	Likelihood	Risk	Safeguards	Recommendations	Comment
								exterior surfaces of the Rotor Sail 5. Drainages in the foundation of the Rotor Sail such that water inside the steel structures will drain out through gratings		
			3. Fire escalating to the composite layers, causing damage	Asset	4	B	High			
			4. Water accumulation at the bottom due to firewater system activation	Asset	3	B	Moderate			

6	Vessel Operational Modes
<p>Ferry Vessel Operational Modes with Rotor Sail Operational Mode:</p> <ol style="list-style-type: none"> <li>1) In the port: Rotor Sail is in AUTO Mode (or depending on the crew's decision)</li> <li>2) Manoeuvring (entry/exit) the port: Rotor Sail is in AUTO Mode</li> <li>3) Vessel Sailing: Rotor Sail is in AUTO Mode</li> <li>4) Vessel Maintenance: Rotor Sail is in IDLE Mode or OFF Mode if there is no power</li> <li>5) Harsh Weather: Rotor Sail is in INVISIBLE Mode</li> </ol>	

No.: 6		Vessel Operational Modes								
Item	Deviation	Causes	Consequences	Matrix	Severity	Likelihood	Risk	Safeguards	Recommendations	Comment
6.1	No additional risks identified for normal vessel operation modes. For the Rotor System Operation Modes, refer to node 4.									

7	Installation Hazards
<p>Installation:</p> <ul style="list-style-type: none"> <li>- Lift plan and analysis, installation plan is to be approved by all stakeholders</li> <li>- Foundations (for fixed) or pedestals (for tilting) will be prefabricated and installed by shipyards</li> <li>- Cabling and breakers by shipyards</li> <li>- Control panel and electric cabinets delivered by Norsepower, installed by shipyard</li> <li>- Rotor Sails delivered, pre-assembled and tested by Norsepower</li> <li>- Connected to the foundation by bolts</li> <li>- Commissioning and sea trial testing (functional testing)</li> <li>- 1 Rotor Sail can be installed within 24 hours (typical), but tilting foundation may require more time</li> </ul>	

No.: 7		Installation Hazards								
Item	Deviation	Causes	Consequences	Matrix	Severity	Likelihood	Risk	Safeguards	Recommendations	Comment
7.1	Lifting Hazards and Dropped Objects	1. Dropped Objects During Installation due to: <ul style="list-style-type: none"> <li>- human error</li> <li>- inadequate lift equipment/gears</li> <li>- higher lifts to install Rotor Sail comparing to normal lifts for passenger vessels</li> </ul>	1. Dropped Objects During Installation, vessel and crane damage	Asset	3	C	High	1. Lift and Material Handling Analysis conducted to evaluate all the installation lift risks 2. Worker Job Safety Analysis (JSA) 3. Drop exclusion zones established to prevent human injury 4. Certified lifting equipment and cranes and design safety factors 5. Crew training for installation and lifting 6. Lift plan considers weather conditions		
			2. Human injury	Injury	4	B	High			



8	Hazards in Port & SIMOPs
Notes:	
- Ferry voyage duration is approximately two hours.	

No.: 8		Hazards in Port & SIMOPs								
Item	Deviation	Causes	Consequences	Matrix	Severity	Likelihood	Risk	Safeguards	Recommendations	Comment
8.1	Collision with overhead objects in port	1. Air draft * - Wind-Assisted Propulsion System (Rotor Sails) & System Operational Modes (linked from 2.15)								
8.2	Simultaneous Operations (SIMOPS)	1. There is no risk identified with SIMOPs activities with the installation of Rotor Sail onboard.								- for example: refuelling or bunkering of the vessel, embarkation/disembarkation of the passengers.
8.3	Helicopter Operations at Sea	1. Helicopter approaching due to emergency evacuation from the vessel	1. Helicopter collision with Rotor Sail	Overall	S3-Moderate	LC-Possible	High	1. Specialised Pilot Training & Safe Practices 2. Helideck locations and arrangements complied with CAP 437 regulation and class rules. 3. Toggle switch to stop Rotor Sail in case of helicopter operations 4. Flight Obstruction lights on top of the Rotor Sail		- Vessel design with Rotor Sail complied with "CAP 437: Standards for offshore helicopter landing areas", key requirement is to have 2x the diameter of the helideck. - helicopter approaches from the other side of the Rotor Sail.
			2. Fire/Explosion, asset impact, human injury	Overall	S4-Major	LB-Unlikely	High			

9	Maintenance & Inspection
<p>Maintenance:</p> <ul style="list-style-type: none"> <li>- System design life and composite material design life is approximately 25 years</li> <li>- 150,000+ hours of real-life operation</li> <li>- Retrofit and new installation</li> <li>- Maintenance manual and frequency is based on the vessel</li> <li>- Maintenance and inspection can be done by vessel crew</li> <li>- Monthly and biweekly checks, yearly inspection tasks</li> <li>- Design is to avoid maintenance on lights on top of Rotor Sail as much as possible, but the lights are also accessible with climbing ropes available.</li> </ul>	

No.: 9		Maintenance & Inspection								
Item	Deviation	Causes	Consequences	Matrix	Severity	Likelihood	Risk	Safeguards	Recommendations	Comment
9.1	Worker experiencing oxygen deficiency during inspection and maintenance	1. Insufficient air flow in the Rotor Sail	1. Worker experiencing oxygen deficiency during inspection and maintenance	Injury	3	B	Moderate	1. Air flow through hatches and openings on top and through roller bearings at the bottom. 2. Harness to lower injured person to safety. 3. Design analysis considers the top and bottom opening area requirements for ventilations, air flow		
			2. Human injury and unconsciousness	Injury	3	B	Moderate			
9.2	Workers working at height / falling	1. Workers working at height for maintenance/inspection since the Rotor Sail is 30 m high	1. Worker falling & personnel injury	Injury	4	B	High	1. Fall Protection Equipment (harness) 2. Safety railings in the middle of the ladder 3. Maintenance platform inside the Rotor Rail is grated		- higher motions due to wind and waves create additional risk for workers.

No.: 9		Maintenance & Inspection								
Item	Deviation	Causes	Consequences	Matrix	Severity	Likelihood	Risk	Safeguards	Recommendations	Comment
9.3	Dropped Objects during maintenance	1. Equipment become loose during maintenance and inspection activities	1. Tools and/or components falling from height, asset damage	Asset	3	B	Moderate	1. Inspection and Maintenance Safe Practices 2. Rotor Sail design is drop proof, with measures (double knots and thread locking) to prevent drop potentials	11. Evaluate the Rotor Sail design for drop potentials (loose equipment, vibrations, etc.) and develop prevention and/or mitigation measures to minimise the impact of potential drops on crew and vessel structures. 12. Inspection and maintenance procedures to consider drop potential and the impact on crew and structure damage. Consider having drop protection practices in place.	
			2. Human Injury if there is a person underneath	Injury	4	B	High			
		2. Drop Potential (loose equipment from Rotor Sail while rotating) - Wind-Assisted Propulsion System (Rotor Sails) and System Operational Modes (linked from 2.16)								
9.4	Electrocution hazards	1. Worker exposed to electrical energy in equipment during maintenance and inspection	1. Electrocution, human injury	Injury	3	B	Moderate	1. Inspection and maintenance safe practices 2. When the system is energised and the worker		

No.: 9		Maintenance & Inspection								
Item	Deviation	Causes	Consequences	Matrix	Severity	Likelihood	Risk	Safeguards	Recommendations	Comment
								is inside, the worker is doing inspection only 3. System is de-energised for worker maintenance activities to minimise electrocution risks 4. Workers wearing PPE during maintenance		
9.5	Rotating machines	1. Rotor is rotating at idle speed during maintenance	1. Human injury due to rotating components (motors, lower roller bearings)	Injury	3	B	Moderate	1. Crew training for maintenance and inspection safe practices 2. Warning sign on the access route to rotor side to prevent worker from entering when the Rotor Sail is rotating 3. Workers wearing PPE during maintenance		- worker can be taking measurements on rotating parts
9.6	High temperature inside the Rotor Sail	1. High ambient temperature outside and direct sunlight	1. Worker discomfort and heat injury due to high temperature inside the Rotor Sail during maintenance	Injury	2	B	Low	1. Workers working short shifts 2. Worker Job Safety Analysis	17. Depending on the vessel location (hot climate), consider the impact to worker comfort and heat injury when conducting maintenance/inspection activities in the Rotor Sail at high temperature and develop procedures and heat prevention practices (portable fans, water).	

## Appendix VI – List of Recommendations General Cargo vessel using VentoFoil© (Suction Wings)

No.	Action	References
1	Sensors to monitor loads on the foundation.	1.2 Structural interfaces and strengths, loads – Vessel General Arrangement *
2	Address alternatives for visibility.	1.2 Structural interfaces and strengths, loads – Vessel General Arrangement *
3	Design criteria for Ventofoil structure considering the max anticipated wind speed and operational restrictions are to be developed.	1.2 Structural interfaces and strengths, loads – Vessel General Arrangement *
4	Design needs to consider the fatigue analyses, which are to be performed/updated.	1.2 Structural interfaces and strengths, loads – Vessel General Arrangement *
5	Slew bearing must be selected considering the green waters.	1.2 Structural interfaces and strengths, loads – Vessel General Arrangement *
6	All mechanical components and materials are to be selected to specifically deal with green water.	1.2 Structural interfaces and strengths, loads – Vessel General Arrangement *
7	Take into consideration ice conditions to stability calculations.	1.2 Structural interfaces and strengths, loads – Vessel General Arrangement *
8	Consider max. 30 degrees in the hydraulic design and avoid spillage by providing appropriate height to the breathing goose neck on the hydraulic unit oil tank.	1.2 Structural interfaces and strengths, loads – Vessel General Arrangement * 2.3 Excessive Vessel Motion – Wind-Assisted Propulsion System & System Operational Modes *
9	Hydraulic system to add hydraulic damper to avoid hydraulic vibrations.	1.2 Structural interfaces and strengths, loads – Vessel General Arrangement *
10	For each installation vibration survey to be conducted	1.2 Structural interfaces and strengths, loads – Vessel General Arrangement *
11	Hull slamming vibrations are to be considered in the design.	1.2 Structural interfaces and strengths, loads – Vessel General Arrangement *
12	Operational procedures and safety measures are to be further studied in case of high-wind situations, or in case the wings' hydraulics break.	1.2 Structural interfaces and strengths, loads – Vessel General Arrangement *
13	Work with Flag for the exemptions for the navigation lights and bridge view obstruction	1.3 Vessel visibility obstructions, and radar and navigation lighting – Vessel General Arrangement *
14	Position of the VentoFoil to take under consideration the obstruction issues in advance (design phase)	1.3 Vessel visibility obstructions, and radar and navigation lighting – Vessel General Arrangement *
15	Location of VentoFoil to be selected to avoid obstructions and blockages of walkways.	1.5 Obstruction to the Accessibility (walkway) - Escape, Evacuation, and Rescue (EER) measures – Vessel General Arrangement *
16	Proper calculations to be performed for the stability and work with the Classification (e.g., static dynamic damage, considering VentoFoil up).	1.6 Stability – Vessel General Arrangement *
17	For each ship type, studies are to be performed considering the various cargo operations and their impact to the VentoFoil and its position.	1.7 Obstruction for cargo loading/unloading – Vessel General Arrangement *
18	Impact on the rudder loads is to be further studied due to additional loads created from the VentoFoil	1.15 Manoeuvrability – Vessel General Arrangement *
19	Manoeuvrability studies are to be conducted considering the number and locations of the VentoFoil	1.15 Manoeuvrability – Vessel General Arrangement *
20	Operation manual to include resting procedures and monitor.	1.10 VentoFoil rest – Vessel General Arrangement *
21	At initial stages of the project, proper location of the VentoFoil to also consider economic benefits.	1.13 Aerodynamics – Vessel General Arrangement *
22	Studies to be performed to determine any change needed for mooring and anchor equipment and capacity.	1.16 Equipment number – Vessel General Arrangement *

No.	Action	References
23	Increased speed impact to be further looked at from a fuel saving perspective and structural issues.	1.17 Impact of vessel speed – Vessel General Arrangement *
24	Impact on the tonnage to be studied and booklets are to reflect that (to be updated accordingly)	1.18 Impact on gross tonnage – Vessel General Arrangement *
25	All the equipment should be selected according to the marine operating environment.	2.3 Excessive Vessel Motion – Wind-Assisted Propulsion System and System Operational Modes*
26	The fire consequences are to be further studied depending on the various ship types and consider fire hydrants to spray the water.	2.8 High temperature of motors (Overheating) – Wind-Assisted Propulsion System and System Operational Modes *
27	All electrical cables are to be certified for marine environment.	2.8 High temperature of motors (Overheating) – Wind-Assisted Propulsion System and System Operational Modes *
28	Further studies to be performed for corrosion potential and proper quality checks during manufacturing and in-service inspection procedures to be established.	2.15 Corrosion of overall system – Wind-Assisted Propulsion System and System Operational Modes*
29	Based on the SDS data further studies to be done for any chance for pollution and consider scenarios to contain the potential leak during the operations or maintenance	12.1 Leakage of connections – Hydraulic system*
30	The system level FMEA is to be performed.	12.1 Leakage of connections – Hydraulic system*
31	This scenario is to be further evaluated and safety detections are to be provided.	12.2 Hose failure – Hydraulic system*
32	Further studies to be performed for such situations.	12.3 Hydraulic lock fails – Hydraulic system*
33	Consider regular inspection to see if there is clogging on the filter.	12.4 Clogging – Hydraulic system*
34	Further studies to be done and proper fluid or heat tracing to be considered.	12.7 Hydraulic fluid exposed to low temperature – Hydraulic system*
35	Fire-fighting mitigations and philosophy to be considered.	13.1 Electrical fire – Electrical system*
36	Depending on the ship types and hazardous areas, appropriate protection equipment is to be selected depending on the hazards.	13.1 Electrical fire – Electrical system*
37	Consider equipment suitable and certified for marine environment/operation.	13.3 Weather impact – Electrical system*
38	Operations manual to include check before raising or lowering e.g., that nobody is in the area, no other operations are happening, cranes, obstructions etc.	4.1 VentoFoil Up/Down (using electronic control in wheelhouse) – Control/Automation System*
39	Design to consider VentoFoil contact area at the boom rest considering loads due to the resting.	4.1 VentoFoil Up/Down (using electronic control in wheelhouse) – Control/Automation System*
40	Consideration of additional radars	1.3 Vessel visibility obstructions, and radar and navigation lighting – Vessel General Arrangement*
41	Investigate and provide appropriate action plan for the system recovery (putting VentoFoil in safe position)	4.1 VentoFoil Up/Down (using electronic control in wheelhouse) – Control/Automation System*
42	Proper system level FMECA needs to be performed.	4.2 VentoFoil rotation – Control/Automation System*
43	Design limitations are to be considered for the VentoFoil	4.2 VentoFoil rotation – Control/Automation System*
44	Water drainage from the VentoFoil is to be further studied considering green water, ice formation inside, heavy rain.	6.2 Normal sailing - VentoFoil down – Vessel Operational Modes*
45	Depending on the ship types (freeboard etc.) impact of sea water should be further studied.	6.2 Normal sailing - VentoFoil down – Vessel Operational Modes*
46	Impact on the buoyancy due to the green water is to be considered.	6.2 Normal sailing - VentoFoil down – Vessel Operational Modes *
47	If VentoFoil is up, owner to perform operating study.	6.3 In port - VentoFoil Up – Vessel Operational Modes*
48	Consider providing warning lights in case VentoFoil is sticking out in downward position.	6.4 In port - VentoFoil down – Vessel Operational Modes*

<b>No.</b>	<b>Action</b>	<b>References</b>
49	Raising and lowering in bad weather are to be further studied and appropriate mitigations and recommendations are to be provided to the crew and added to the manual.	6.5 Transition - VentoFoil up to down – Vessel Operational Modes*
50	Boom rest and lashing are to be designed considering the worst load condition during any operational phase.	6.8 Passing through storm - VentoFoil Down – Vessel Operational Modes*
51	Survey of fire hazards on areas of Ventofoil installation to be performed.	7.4 Fire Hazard – Installation Hazards*
52	Perform separate HAZID and SIMOPS with the owner of such vessels (special purpose ships) for Ventofoil operation.	8.2 Simultaneous Operations (SIMOPS) on ships dredgers and trawlers – Hazards in Port and SIMOPS*
53	Handling maintenance procedures to be developed and incorporated in the manuals.	9.2 Workers working at height / falling – Maintenance and inspection*
54	Ship's procedure to include PPE.	9.3 Dropped Objects during maintenance – maintenance and inspection*

## Appendix VII – HAZID Register General Cargo vessel using Ventofoil© (Suction Wings)

1	Vessel General Arrangement *
<p>The VentoFoil is designed to generate forward thrust through lift created by wind. The rigid wing sail will rotate/slew into the wind at an angle of attack of about 25 degrees. The powered slewing bearing can rotate within 310 degrees to ensure optimal angle of attack. There is an area between approximately +/- 25 degrees from the bow where the VentoFoil will not create forward thrust (sailing into the wind).</p> <p>When the VentoFoil is in the correct position, ventilations fans located in the wing sail will be set at an optimal speed according to wind speed via Variable Frequency Drives (VFDs). They will suck wind into the wing sail and create a laminar wind flow along the wing sail, which enable much larger angles of attack (~25°) than a traditional wing (12°). The lift coefficient will be much higher than a traditional sail and still several times higher than a modern rigid wing sail. The frequency control ventilators adjust the speed according to the wind speed and reverse when tacking. They are at maximum revolutions when the wind speed is 14m/s, which is maintained until 17m/s (31.5 knots ~ Beaufort 7).</p> <p>The angle of attack of the wing sail is lowered beyond this wind speed by keeping the Lift force constant until it is in weathervane position, which it reaches at 22m/s (~Beaufort 4). Stalling wind is used to prevent an over-powered sail. Optimal forward thrust will be created when the apparent wind comes from the side of the vessel. Wind from the stern creates less forward thrust. Sailing by drag is possible but the opportunity does not occur very often as tailwinds are rare with typical ship speeds.</p> <p>The VentoFoil is designed to remain upright in storm and hurricane conditions. Luffing or tilting the VentoFoil down for securing, storage, drag reduction in headwinds, or removing them out of the way for cargo operations is optional.</p> <p>The VentoFoil is designed for -20-32°C, but sailing in areas with a risk of ice and icing is optional. The VentoFoil shall not be operated while a pilot is on board and in narrow channels or restricted waters to not interfere with the vessel's manoeuvrability.</p>	

No.: 1		Vessel General Arrangement *								
Item	Deviation	Causes	Consequences	Matrix	Severity	Likelihood	Risk	Safeguards	Recommendations	Comment
1.1	Location of VentoFoil onboard the vessel	1.								On the forward of the vessel. Lowered forward or aft by positioning appropriately the cylinders



No.: 1		Vessel General Arrangement *								
Item	Deviation	Causes	Consequences	Matrix	Severity	Likelihood	Risk	Safeguards	Recommendations	Comment
1.2	Structural interfaces and strengths, loads	1. Higher load than expected due to ship motion	1. Structural failure, fatigue failure, collapse	Asset	3	C	High	1. Design to consider all motion for installed vessel 2. Design according to class rules 3. System of VentoFoil is weaker than hull	1. Sensors to monitor loads on the foundation 2. Address alternatives for visibility	
			2. Downtime for repair	Asset	3	D	High			
			3. System not functioning	Asset	3	D	High			
			4. Hull rupture	Asset	3	D	High			
			5. Hatch covers rupture - compromise the watertight integrity	Asset	3	C	High			
			6. Damage to critical systems forward (navigation lights, radar)	Asset	1	C	Low			
		2. Higher load than expected due to high wind speed	1. Structural failure, fatigue failure, collapse	Asset	3	C	High	4. Expected nobody on the ship deck forward in adverse seas 5. Internal motors, IP66	3. Design criteria for Ventofoil structure considering the max anticipated wind speed and operational restrictions are to be developed 4. Design needs to consider the fatigue analysis and are to be performed/updated	
			2. Downtime for repair	Asset	3	D	High			
			3. System not functioning	Asset	3	D	High			
			4. Hull rupture	Asset	3	D	High			

No.: 1		Vessel General Arrangement *								
Item	Deviation	Causes	Consequences	Matrix	Severity	Likelihood	Risk	Safeguards	Recommendations	Comment
			5. Hatch covers rupture - compromise the watertight integrity	Asset	3	C	High			
			6. Damage to critical systems forward (navigation lights, radar)	Asset	1	C	Low			
			7. Collapse due to the higher load	Asset	3	C	High			
			8. Damage to electrical equipment	Asset	3	C	High			
		3. Green-sea loads	1. Structural failure, fatigue failure, collapse	Asset	3	C	High	5. Internal motors, IP66 6. Advanced IP66 measures (additional measures are in place) 7. Cylinders are specified to operate in green-sea environments 8. Location of HPU is selected to avoid exposure to green water - always protected 9. Sensors are selected to operate in green-sea environment and appropriately located	5. Slew bearing must be selected considering the green waters 6. All mechanical components and materials are to be selected appropriately to deal with the green water	
			2. Downtime for repair	Asset	3	D	High			
			3. System not functioning	Asset	3	D	High			
			4. Hull rupture	Asset	3	D	High			
			5. Hatch covers rupture - compromise the watertight integrity	Asset	3	C	High			

No.: 1		Vessel General Arrangement *								
Item	Deviation	Causes	Consequences	Matrix	Severity	Likelihood	Risk	Safeguards	Recommendations	Comment
			6. Damage to critical systems forward (navigation lights, radar)	Asset	1	C	Low			
			9. Damage to the HPU and electrical equipment	Asset	3	C	High			
			10. Damage to the bearing cylinder	Asset	3	C	High			
			11. Corrosion	Asset	3	C	High			
		4. Higher load than expected due to ice Comment: (-20°), When upright 30kg/m <sup>2</sup> ice built up (ice class rules) (tbc)	3. System not functioning	Asset	3	D	High	10. During upright the design to consider ice load built up as per class rules 11. Stability considered ice conditions	7. Take into consideration ice conditions to stability calculations	
			12. Extra weight, additional vertical gravity, reduced stability	Asset	3	B	Moderate			
		5. Damage conditions to the ship Comment: 30 degree normally, ± 10 Degree/22-degree roll (depending on class rules)/ Strength of wings: 30° is low load, when the ship is stopped no problem for the wings	1. Structural failure, fatigue failure, collapse	Asset	3	C	High	12. VentoFoil support structure is designed taking under consideration the damage conditions of the ship	8. Consider max 30 degree in the hydraulic design and avoid spillage by providing appropriate height to the breathing goose neck on the hydraulic unit oil tank	
			13. VentoFoil may separate from the ship	Asset	3	B	Moderate			
			14. Hydraulic spill from hydraulic tank	Overall	S3-Moderate	LC-Possible	High			

No.: 1		Vessel General Arrangement *								
Item	Deviation	Causes	Consequences	Matrix	Severity	Likelihood	Risk	Safeguards	Recommendations	Comment
		6. Vibrations (ship induced, wind induced, slamming induced)	15. Fatigue damage to the structures and machinery	Asset	3	C	High	13. Install systems shows no vibrations issues	9. Hydraulic system to add hydraulic damper to avoid hydraulic vibrations 10. For each installation vibration survey to be conducted	
		7. Hull slamming	15. Fatigue damage to the structures and machinery	Asset	3	C	High		11. Hull-slamming vibrations are to be considered in the design	
		8. Wind perpendicular to the wing							12. Proper operational procedures and safety measures are to be further studies in case of high wind situation or in case of brokage of hydraulics of wings	
1.3	Vessel visibility obstructions, and radar and navigation lighting	1. VentoFoil blocking the view from the bridge							13. Work with Flag for the exemptions for the navigation lights and bridge view obstruction 14. Position of the VentoFoil to take under consideration the obstruction issues in advance (design phase)	There is some obstruction, to the top aft navigation lights. Bridge obstruction need to comply with rules. For the lights you can get exemption from Flag. Side lights need to be checked if they are obscured.
		2. VentoFoil covering the navigation lights							13. Work with Flag for the exemptions for the navigation lights and bridge view obstruction 14. Position of the VentoFoil to take under	

No.: 1		Vessel General Arrangement *								
Item	Deviation	Causes	Consequences	Matrix	Severity	Likelihood	Risk	Safeguards	Recommendations	Comment
									consideration the obstruction issues in advance (design phase)	
		3. VentoFoil creating interference for the radar Comment: Radar antenna 1.5 m, across entire length it sends signal. MSC. Circ 271_7.5(b) and resolution states the percentage that can be obstructed.	1. Blind sector due to the VentoFoil	Overall	S2-Minor	LC-Possible	Moderate	1. VentoFoil may be put down in heavily congested areas 2. Blind sectors drawing provided to the owner for appropriate preparation 3. Additional cameras are installed	40. Consideration of additional radars	
1.4	Vessel air drafts	1. Obstruction with cranes at port or other structures	1. Damage to VentoFoil and other structures	Asset	3	D	High	1. VentoFoil can be lowered in the areas where obstructions may happen		
			2. In port - VentoFoil Up - Vessel Operational Modes * (linked to 6.3)							
		2. Passing under port bridge	1. Damage to VentoFoil and other structures	Asset	3	D	High	1. VentoFoil can be lowered in the areas where obstructions may happen		
			2. In port - VentoFoil Up - Vessel Operational Modes * (linked to 6.3)							
1.5	Obstruction to the Accessibility (walkway) - Escape, Evacuation, and	1.								

No.: 1		Vessel General Arrangement *								
Item	Deviation	Causes	Consequences	Matrix	Severity	Likelihood	Risk	Safeguards	Recommendations	Comment
	Rescue (EER) measures									
1.6	Stability	1. Higher wind force may create stability issue	1. Failure to fulfil the stability requirements						16. Proper calculations to be performed for the stability and work with the classification (e.g., static dynamic damage, considering VentoFoil up)	
1.7	Obstruction for cargo loading/unloading	1. Interference with material handling equipment	1. Damage to the VentoFoil structure	Asset	2	C	Moderate	1. The VentoFoil is designed to fold down during loading/unloading of the cargo	17. For each ship type, studies are to be performed considering the various cargo operations and their impact to the VentoFoil and its position	Depending on ship type. General cargo ships are the most challenging due to the cranes.
1.8	Impact on trim	1. Weight from loading of the VentoFoil	1. Issue with managing the trim of the ship	Asset	1	C	Low			No significant impact
			2. Impact to the manoeuvrability due to the trim	Asset	1	C	Low			
		2. Manoeuvrability (linked from 1.15)								
1.9	Green sea									See 1.2, cause 3 Green-sea load
1.10	VentoFoil rest	1. Heavier load on ship structure and the movement	1. Damage to ship structure	Asset	3	B	Moderate	1. When on the boom rests, these have been designed to address the dynamic and static loads		
			2. Damage to VentoFoil	Asset	3	C	High			

No.: 1		Vessel General Arrangement *								
Item	Deviation	Causes	Consequences	Matrix	Severity	Likelihood	Risk	Safeguards	Recommendations	Comment
		2. VentoFoil orientation incorrect	2. Damage to VentoFoil	Asset	3	C	High	2. System is designed to provide warning in case of wrong orientation of VentoFoil for the rest position 3. Interlock, if in wrong position, hydraulics will not allow to operate. 4. Sensors 5. Hydraulic cylinder are locked to prevent any uplift	20. Operation manual to include resting procedures and monitor	
1.11	Interference with mooring equipment and walkway									see 1.5
1.12	Hull slamming									See 1.2.7
1.13	Aerodynamics	1. Improper position of VentoFoil	1. Economic benefit not realised						21. At initial stage of the project, proper location of the VentoFoil to also consider economic benefits	
1.14	VentoFoil Structural foundation									see 1.2
1.15	Manoeuvrability	1. Transverse lift due to the wind force	1. Rudder must operate at an angle						18. Impact on the rudder loads are to be further studied due to additional loads created from the VentoFoil	
			2. Automatic navigation may cease							

No.: 1		Vessel General Arrangement *								
Item	Deviation	Causes	Consequences	Matrix	Severity	Likelihood	Risk	Safeguards	Recommendations	Comment
		2. If higher thrust due to the VentoFoil	3. Inability for manoeuvre						19. Manoeuvrability studies are to be conducted considering the number and locations of the VentoFoil	
1.16	Equipment number	1. Additional load due to VentoFoil	1. Capacity of current anchor and mooring not enough	Overall	S2-Minor	LB-Unlikely	Low		22. Studies to be performed to determine any change needed for mooring and anchor equipment and capacity	
1.17	Impact of vessel speed	1. VentoFoil may assist in increase vessel speed	1. Impact on hull strength					1. Incentive for fuel savings (reduce speed) 2. Operational restriction to reduce speed to original calculations	23. Increased speed impact to be further looked at from a fuel saving perspective and structural issues	
			2. Impact on fatigue life							
			3. Impact on rudder							
			4. Impact on manoeuvrability							
1.18	Impact on gross tonnage	1. GT changes due to VentoFoil	1. Higher harbour costs, more crew etc.	Overall	S1-Low	LD-Likely	Moderate		24. Impact on the tonnage to be studied and booklets are to reflect that (to be updated accordingly)	



2	Wind-Assisted Propulsion System & System Operational Modes *
Wind-Assisted Propulsion System and System Operational Modes *	

No.: 2		Wind-Assisted Propulsion System & System Operational Modes *								
Item	Deviation	Causes	Consequences	Matrix	Severity	Likelihood	Risk	Safeguards	Recommendations	Comment
2.1	Ambient temperature too low (below - 20°C)	1.								
2.2	Excessive Wind Speed									See node 1
2.3	Excessive Vessel Motion	1. Hydraulic oil spill due to motions (sloshing)	1. Premature failure of the equipment	Asset	3	C	High		8. Consider max 30 degree in the hydraulic design and avoid spillage by providing appropriate height to the breathing goose neck on the hydraulic unit oil tank	
			2. Potential for pollution	Environmental	3	B	Moderate			
		2. Electrical motor and fans impacted by the motion of the ships	1. Premature failure of the equipment	Asset	3	C	High		25. All the equipment to be selected according to the marine operating environment	
2.4	Green water (machinery)							1. All equipment and enclosure cabinets are IP66 or higher 2. All sensors are protected and outside of direct contact with green water		

No.: 2		Wind-Assisted Propulsion System & System Operational Modes *								
Item	Deviation	Causes	Consequences	Matrix	Severity	Likelihood	Risk	Safeguards	Recommendations	Comment
2.5	Ice accumulation									See node 1
2.6	Vibration issues (machinery)									No additional issues identified considering there are no major vibrations
2.7	Bearing temperature									Not an issue
2.8	High temperature of motors (Overheating)	1. Higher load, short circuit	1. High temperature of the motor	Asset	2	C	Moderate	1. Temperature monitoring, overload circuit protection	26. The fire consequences are to be further studied depending on the various ship types and consider fire hydrants to spray the water 27. All electrical cables are to be certified for marine environment	3KW motors
			2. Electrical fire (only source are the motors and the fans and possibly the paint coating)	Asset	2	C	Moderate			
			3. Impact on VentoFoil bond structures (glue)	Asset	2	C	Moderate			
		2. Bearing failure	2. Electrical fire (only source are the motors and the fans and possibly the paint coating)	Asset	2	C	Moderate			
2.9	Noise impact									No issue identified

No.: 2		Wind-Assisted Propulsion System & System Operational Modes *								
Item	Deviation	Causes	Consequences	Matrix	Severity	Likelihood	Risk	Safeguards	Recommendations	Comment
2.10	Water Condensation inside the VentoFoil									No issue identified. Any condensed water will drip on the side
2.11	Equipment number changes									See node 1, 1.16
2.12	Air draft									see node 1
2.13	Drop Potential									No drop potential issue except anemometer which is secured
2.14	Electrical fire									See 2.8
2.15	Corrosion of overall system	1. Dissimilar materials (aluminium, galvanised steel)	1. Corrosion damage	Asset	3	B	Moderate	1. Separation of metals by bonding material 2. Duralac paint	28. Further studies to be performed for corrosion potentials and proper quality checks during manufacturing and in service inspection procedures to be established	At various place of aluminium and steel, glue, connectivity issues (dissimilar materials at various places)
		2. Potential charge built up	1. Corrosion damage	Asset	3	B	Moderate			

3	System Interfaces *
System Interfaces *	

No.: 3		System Interfaces *								
Item	Deviation	Causes	Consequences	Matrix	Severity	Likelihood		Safeguards	Recommendations	Comment
							Risk			
3.1	Loss of power supply to VentoFoil	1. No power	1. Unable to operate the VentoFoil					1. Hand pump can be used to lower the VentoFoil		see 13.2
3.2	Anemometer									On top of VentoFoil in current projects. Each VentoFoil has its own anemometer. No major issues identified.

4	Control/Automation System *
Control/Automation System	

No.: 4		Control/Automation System *								
Item	Deviation	Causes	Consequences	Matrix	Severity	Likelihood	Risk	Safeguards	Recommendations	Comment
4.1	VentoFoil Up/Down (using electronic control in wheelhouse)	1. Improper orientation of the VentoFoil	1. Damage of the VentoFoil when is put at rest	Asset	2	D	High		38. Operations manual to include check before raising or lowering e.g., that nobody is in the area, no other operations are happening, cranes, obstructions etc. 39. Design to consider VentoFoil contact area at the boom rest considering loads due to the resting	
		2. Sensors giving wrong information	1. Damage of the VentoFoil when is put at rest	Asset	2	D	High	1. There are markings on the VentoFoil outside, to check alignments 2. Markings are visible from the bridge		
		3. Sensors are not working								
		4. Interference not intuitive	2. Unable to bring down the VentoFoil	Overall	S3-Moderate	LD-Likely	High	3. Proper design of human interface 4. Visual check that nobody is in the area when Ventofoil comes down		
			3. Injury to human	Injury	3	D	High			

No.: 4		Control/Automation System *								
Item	Deviation	Causes	Consequences	Matrix	Severity	Likelihood	Risk	Safeguards	Recommendations	Comment
		5. Failure in hydraulic system etc.	3. Injury to human	Injury	3	D	High	5. Sound and flashlight to notify people that VentoFoil is coming down 6. Counterbalance valve at cylinder will cease further lowering of the VentoFoil 7. Appropriate spares parts are available	41. Investigate and provide appropriate action plan for the system recovery (putting VentoFoil in safe position)	
4.2	VentoFoil rotation	1. Unable to rotate	1. Cannot bring down the VentoFoil	Overall	S3-Moderate	LD-Likely	High		42. Proper system level FMECA need to be performed 43. Design limitations are to be considered for the VentoFoil	
			2. Cannot align appropriately with the wind for max benefit	Overall	S3-Moderate	LB-Unlikely	Moderate			
			3. Excessive load to the VentoFoil due to high wind, storm	Overall	S3-Moderate	LB-Unlikely	Moderate			
		2. Unable to supply hydraulic fluid								
		3. Hose failure								
		4. Bad maintenance of hydraulic system							42. Proper system level FMECA need to be performed	
4.3	VentoFoil fan control	1. Unable to control the fan	1. Generating max lift when manoeuvrability is important	Asset	3	B	Moderate	1. Manual restrictions not the use VentoFoil when manoeuvring or pilot is onboard 2. Manually cut the power to the fan		

No.: 4		Control/Automation System *								
Item	Deviation	Causes	Consequences	Matrix	Severity	Likelihood	Risk	Safeguards	Recommendations	Comment
								3. Emergency stop		
		2. Fan not operating	2. VentoFoil benefit not realised	Overall	S3-Moderate	LB-Unlikely	Moderate			
4.4	Automatic stops in high wind									No additional risk identified

5	Utilities system *
Utilities system *	

No.: 5		Utilities system *								
Item	Deviation	Causes	Consequences	Matrix	Severity	Likelihood		Safeguards	Recommendations	Comment
							Risk			
5.1	Electrical power									no issue identified



6	Vessel Operational Modes *
Vessel Operational Modes *	

No.: 6		Vessel Operational Modes *								
Item	Deviation	Causes	Consequences	Matrix	Severity	Likelihood	Risk	Safeguards	Recommendations	Comment
6.1	Normal sailing - VentoFoil Up									No additional issue identified
6.2	Normal sailing - VentoFoil down	1. Green water	1. Higher load to the VentoFoil	Asset	3	D	High	1. All electrical equipment are IP66 rated 2. VentoFoil is closed at bottom, so water does not enter from there 4. Green water barriers will be provided from the owners 5. Owners of existing ships will provide info on how to handle it	44. Water drainage from the VentoFoil are to be further studied considering green water, ice formation inside, heavy rain 45. Depending on the ship types (freeboard etc.) impact of sea water should be further studied 46. Impact on the buoyancy due to the green water is to be considered	
			2. Water inside to the VentoFoil and potential damage to the motor	Asset	2	C	Moderate			
			3. Damage to the anemometer	Asset	2	D	High			
			4. Sea water debris entering the VentoFoil	Asset	2	B	Low			
			5. Buoyancy uplift impact due to the submersion of	Asset	2	B	Low			

No.: 6		Vessel Operational Modes *								
Item	Deviation	Causes	Consequences	Matrix	Severity	Likelihood	Risk	Safeguards	Recommendations	Comment
			the VentoFoil due to the green water							
6.3	In port - VentoFoil Up	1. Interference during cargo operations								
		2. Interference with other equipment in the port (linked from 1.4)								
		3. Damage by cargo itself (e.g., cement)	2. Dropped cargo	Overall	S3-Moderate	LC-Possible	High	1. Design and type of equipment is selected taking into consideration cargo hazards 2. Washing down		
			3. Cement can damage VentoFoil, inside bearing etc. and block ventilation	Overall	S3-Moderate	LC-Possible	High			
6.4	In port - VentoFoil down	1. VentoFoil outside side limits of the ship	1. Interference with the passing traffic water side	Overall	S3-Moderate	LD-Likely	High	1. Captain considers mooring position in advance	48. Consider providing warning lights in case VentoFoil is sticking out in down position	
			2. Interference with the port traffic on port side	Overall	S3-Moderate	LD-Likely	High			
		2. VentoFoil while down exposed to cargo loading/unloading								
		3. Dropped object	3. Damage to the VentoFoil	Overall	S3-Moderate	LD-Likely	High	2. Operational Procedures		
6.5	Transition - VentoFoil up to down	1. Additional load on VentoFoil bearing	1. Damage to the bearing/gear	Asset	2	C	Moderate	1. No human in the area when VentoFoil is raised or put down	49. Raising and lowering in bad weather are to be further studied and appropriate mitigations and recommendations are to be provided to the	

No.: 6		Vessel Operational Modes *								
Item	Deviation	Causes	Consequences	Matrix	Severity	Likelihood	Risk	Safeguards	Recommendations	Comment
									crew and added to the manual	
			2. VentoFoil is freely rotating on the deck	Overall	S3-Moderate	LB-Unlikely	Moderate			
		2. Additional load on one gear	1. Damage to the bearing/gear	Asset	2	C	Moderate	1. No human in the area when VentoFoil is raised or put down 2. Current manuals included safety information for raising and lower operations 3. Voyage Planning currently considers VentoFoil's transitions (up & down)	49. Raising and lowering in bad weather are to be further studied and appropriate mitigations and recommendations are to be provided to the crew and added to the manual	
			2. VentoFoil is freely rotating on the deck	Overall	S3-Moderate	LB-Unlikely	Moderate			
			3. Injury to human	Injury	3	D	High			
6.6	Transition - VentoFoil down to up	1. Transition - VentoFoil up to down (linked from 6.5) Comment: VentoFoil may not be raised when the weather is bad.								
		2. Lashing is not remote	1. Heavy load onto the Ventofoil	Asset	2	C	Moderate	1. Procedure to remove the lashing before 2. Lashing is designed to withstand the upward force from the hydraulic cylinder		
			2. Breakage of the lashing, damage to the structure	Asset	2	C	Moderate			

No.: 6		Vessel Operational Modes *								
Item	Deviation	Causes	Consequences	Matrix	Severity	Likelihood	Risk	Safeguards	Recommendations	Comment
6.7	Passing through storm - VentoFoil Up									See node 1. In future design will be standardised to withstand all standard loads per class requirements.
6.8	Passing through storm - VentoFoil Down	1. Higher load due to ship motion and wind	1. Lifting or movement from the rest position	Asset	2	B	Low		50. Boom rest and lashing are to be designed considering the worst load condition during any operational phase	
			2. Damage to the VentoFoil	Asset	3	C	High			
6.9	Sailing in limited manoeuvrability area	1. Issue with manoeuvrability with the ship in canals etc.	1. Unable to maintain the course of the ship	Overall	S3-Moderate	LC-Possible	High	1. Restriction in the manual not to operate the VentoFoil 2. Restriction in the manual to tilt it down 3. Manoeuvrability calculations are done considering VentoFoil up and not operating		
			2. Grounding, collision	Overall	S3-Moderate	LC-Possible	High			
6.10	VentoFoil up & fans not running									See 4.3

7	Installation Hazards *
Ventofoil is installed horizontal position.	

No.: 7		Installation Hazards *								
Item	Deviation	Causes	Consequences	Matrix	Severity	Likelihood	Risk	Safeguards	Recommendations	Comment
7.1	Lifting Hazards and Dropped Objects	1. Improper lifting/no clear liner up site	1. Holes not aligned due to relative motion	Overall	S3-Moderate	LC-Possible	High	1. Capable rigger and crane operator 2. Shipyard selection process 3. Job Safety Analysis (JSA) 4. Zone restriction		
			2. Dropped object due to the lift of VentoFoil	Overall	S2-Minor	LC-Possible	Moderate			
			3. Human injury	Overall	S3-Moderate	LC-Possible	High			
		2. High wind								
		3. Relative motion of the ship/load								
7.2	Improper lifting equipment	1. Dropped VentoFoil	1. Dropped VentoFoil	Overall	S3-Moderate	LC-Possible	High	1. Shipyard selection according to capability 2. JSA		Connection is bolded.
			2. Human injury	Injury	3	C	High			
		2. Unable to install due to the operator	1. Dropped VentoFoil	Overall	S3-Moderate	LC-Possible	High	1. Shipyard selection according to capability 2. JSA		
			2. Human injury	Injury	3	C	High			
		3. Accuracy of the crane	1. Dropped VentoFoil	Overall	S3-Moderate	LC-Possible	High	1. Shipyard selection according to capability 2. JSA 3. Zone restriction		
			2. Human injury	Injury	3	C	High			

No.: 7		Installation Hazards *								
Item	Deviation	Causes	Consequences	Matrix	Severity	Likelihood	Risk	Safeguards	Recommendations	Comment
7.3	Damage to the VentoFoil	1. Improper lifting								
		2. Improper rigging equipment								
		3. Peaking at wrong lift point	1. Damage to the VentoFoil	Asset	3	C	High	1. Lifting plan are to be developed 2. Proper lift point to be provided considering centre of gravity 3. JSA 4. Zone restriction		
			2. Rotation of the VentoFoil due to the lift	Asset	2	B	Low			
3. Human injury	Injury	3	C	High						
7.4	Fire Hazard	1. Welding in proximity of fire hazards proximity	1. Fire	Overall	S3-Moderate	LC-Possible	High	1. JSA 2. Permitting for welding	51. Survey of fire hazards on areas of Ventofoil installation to be performed	

8	Hazards in Port & SIMOPs*
Hazards in Port & SIMOPs*	

No.: 8		Hazards in Port & SIMOPs *									
Item	Deviation	Causes	Consequences	Matrix	Severity	Likelihood		Risk	Safeguards	Recommendations	Comment
8.1	Collision with overhead objects in port										see1.4
8.2	SIMOPS on ships dredgers and trawlers	1.								52. Perform separate HAZID and SIMOPS with the owner of such vessels (special-purpose ships) for Ventofoil operation	During these operations, vessel speed will be lower and manoeuvrability will be limited either to the equipment of ship boundaries of the ships
		2.									
8.3	Helicopter Operations at Sea										

9	Maintenance and Inspection *
Maintenance and Inspection *	

No.: 9		Maintenance and Inspection *								
Item	Deviation	Causes	Consequences	Matrix	Severity	Likelihood	Risk	Safeguards	Recommendations	Comment
9.1	Worker experiencing oxygen deficiency during inspection and maintenance									No issue identified - there is enough air circulation
9.2	Workers working at height/ falling	1. Even when at rest, the height is quite substantial	1. Fall, human injury	Injury	3	C	High	1. Proper procedure, fall arrest system	53. Handling maintenance procedures to be developed and incorporated in the manuals	Work is done only at foundation, nobody inside VentoFoil
9.3	Dropped Objects during maintenance	1. Loose bolt	1. Human injury	Injury	3	C	High	1. Bolt is secured using lock tight, washers 2. Bolt size is very small 3. Normally nobody working in the area 4. Plate is secured with bolts 5. Visual inspection of all the bolted connections	54. Ship's procedure to include PPE	
		2. Plate falling								
9.4	Electrocution hazards									No additional hazards



No.: 9		Maintenance and Inspection *								
Item	Deviation	Causes	Consequences	Matrix	Severity	Likelihood	Risk	Safeguards	Recommendations	Comment
9.5	Rotating machines									No additional hazards
9.6	High temperature inside the Ventofoil									During operation, air is flowing, no issue (move to node 6)

10	Materials *
Materials *	

No.: 10		Materials *								
Item	Deviation	Causes	Consequences	Matrix	Severity	Likelihood		Safeguards	Recommendations	Comment
							Risk			
10.1	Dissimilar material									Discussed in Sec 2.15
10.2	Recycling									All materials are to be recycled

11	Manufacturing*
Manufacturing*	

No.: 11		Manufacturing*								
Item	Deviation	Causes	Consequences	Matrix	Severity	Likelihood		Safeguards	Recommendations	Comment
							Risk			
11.1	VentoFoil									VentoFoil follows normal manufacturing practices

12	Hydraulic system*
Hydraulic system*	

No.: 12		Hydraulic system*								
Item	Deviation	Causes	Consequences	Matrix	Severity	Likelihood	Risk	Safeguards	Recommendations	Comment
12.1	Leakage of connections	1. Leakage of connections	1. Spillage on the deck	Overall	S1-Low	LD-Likely	Moderate	1. Spares' list is provided to the owner 2. Design meets the class rules 3. Tank 5 times capacity than the system 4. Redundancy, cloth and wrappings around 5. Counterbalance valve to prevent the fall and losing the pressure	29. Based on the SDS data further studies to be done for any chance for pollution and consider scenarios to contain the potential leak during the operations or maintenance 30. The system level FMEA is to be performed	
			2. Potential for pollution	Environmental	2	B	Low			
			3. Unable to operate the VentoFoil	Asset	2	C	Moderate			
			4. VentoFoil can fall down, low pressure from vertical position	Overall	S3-Moderate	LB-Unlikely	Moderate			
12.2	Hose failure	1. Hydraulic liquid spill from the hose	1. Hydraulic liquid leakage pollution	Environmental	3	B	Moderate	1. Operational monitoring	31. Such scenario are to be further evaluated and safety detections are to be provided	
12.3	Hydraulic lock fails	1. Counterbalance valve fails	1. VentoFoil might fall, reduced pressure	Overall	S3-Moderate	LC-Possible	High		32. Further studies to be performed for such situations	
12.4	Clogging	1. Filter clog due to impurity/external elements	1. Inability to operate hydraulic system	Asset	3	C	High	1. Filter change every year	33. Consider regular inspection to see if there is clogging on the filter	

No.: 12		Hydraulic system*								
Item	Deviation	Causes	Consequences	Matrix	Severity	Likelihood	Risk	Safeguards	Recommendations	Comment
								2. Hydraulic check every 2 years 3. Bypass provided (NRV) and filter in case of clogging		
12.5	VentoFoil hydraulic motor									No issue identified
12.6	Leakage from hydraulic tank due to ship motion	1. Excessive Vessel Motion - Wind-Assisted Propulsion System and System Operational Modes* (linked from Sec 2.3) Comment: Confirm it is the proper node								
		2. Loss of hydraulic fluid						1. Low level alarm		
12.7	Hydraulic fluid exposed to low temperature	1. Low temperature	1. Hydraulic system unable to function due to high viscosity of the fluid in a low temp environment	Asset	3	B	Moderate	1. Heater in the tank always active even in standby mode	34. Further studies to be done and proper fluid or heat tracing to be considered	The system is not operating all the time, thus the fluid lock will not be heated and create a problem
12.8	VentoFoil at angle	1. Improper operations	1. VentoFoil not in the vertical position which can create structural issues	Asset	3	C	High	1. Sensors to stop the system 2. Cylinders are designed to take all the tension load in the worst condition to maintain the vertical position		No mechanical stop in the Ventofoil itself.

No.: 12		Hydraulic system*								
Item	Deviation	Causes	Consequences	Matrix	Severity	Likelihood	Risk	Safeguards	Recommendations	Comment
		2. Sensors giving false positive	1. VentoFoil not in the vertical position which can create structural issues	Asset	3	C	High	1. Sensors to stop the system 2. Cylinders are designed to take all the tension load in the worst condition to maintain the vertical position		

13	Electrical system*
Electrical system. Sensors. Second way of manual control, connected to the weather station. Frequency drive and is connected to the main cabinet. What if there is fire in the main cabinet?	

No.: 13		Electrical system*								
Item	Deviation	Causes	Consequences	Matrix	Severity	Likelihood	Risk	Safeguards	Recommendations	Comment
13.1	Electrical fire	1. Overload, short circuit	1. Electrical fire in the cabinet	Asset	3	C	High		35. Firefighting mitigations and philosophy to be considered 36. Depending on the ship types and hazardous areas appropriate protection equipment are to be selected depending on the hazards	
		2. Electric fire inside Ventofoil (linked from 2.8)								
13.2	Loss of electric power	1. Loss of power	1. Unable to function the system	Asset	2	C	Moderate	1. Manual operation using hydraulic hand pump		
13.3	Weather impact	1. Weather exposure	1. Electrical equipment exposed to weather	Asset	2	B	Low	1. The exposed equipment is rated IP66 2. Cabinets for the electronics are rated IP66 3. All the wires and cables are marine environment appropriate	37. Consider equipment suitable and certified for marine environment/operation	

## Appendix VIII – List of Recommendations Wind Propelled H<sub>2</sub> Assisted Container Carrier

Note: Proprietary information of VEER Group was removed from this report. Therefore, numbering might refer to missing sections.

No.	References	Action
1	1.2.1 Sail Radius obstruction and interference with hazardous area Zones 1 & 2 – Vessel General Arrangement 11.13 Exposure to Li-Ion battery thermal runaway exhausts – Sails 11.13.1 - Exposure to Li-Ion battery thermal runaway exhausts -	Investigate the potential obstruction with sail mast (electrical equipment, 25 motors/sail mast) and the hazardous area Zones from H <sub>2</sub> storage bay and Emergency Power system equipment and any ventilation exhaust or hazardous area exhaust.
2	1.2.1 Sail Radius obstruction and interference with hazardous area Zones 1 & 2 – Vessel General Arrangement	At a detailed design stage when additional details are available, it is recommended to conduct a Hazard Operability (HAZOP) study to validate design changes, system integration, confirm concept design risk profile maturity, assess additional hazards and ensure safeguards are in place to address hazards. Focus on H <sub>2</sub> storage system to Fuel Cell room and battery ESS system, sail mast obstruction with hazardous area zone established by H <sub>2</sub> storage bay and Emergency Power system, and the hazardous area zones from H <sub>2</sub> storage bay and Emergency Power system equipment and any ventilation exhaust or hazardous area exhaust.
3	1.2.1 Sail Radius obstruction and interference with hazardous area Zones 1 & 2 – Vessel General Arrangement	Provide appropriate PPE and portable detectors for crew working in hazardous area zones.
4	1.3.1 Crane Location & operating radius: General recommendations documented to improve design. 1.3.2 Collision/interference/operator error	Cranes to comply with Lifting Appliances rules and certified per class and regulatory requirements
5	1.3.1 Crane Location & operating radius: General recommendations documented to improve design.	Interference study and collision study/analysis to be done to understand risk and how to avoid such event
6	1.4.1 Fire in cargo container bay – Vessel General Arrangement	Consider the impact of cargo container fire on sails and sail equipment (e.g. motor) with recommendations from Sails provider.
7	1.4.1 Fire in cargo container bay – Vessel General Arrangement	In case of cargo container fire, the impact on normal power supply and emergency power supply to be studied considering functional failure modes (e.g. FMECA study) to understand the failure modes and impacts
8	1.4.1 Fire in cargo container bay – Vessel General Arrangement	Consider the impact of cargo container fire on sails and sail equipment (e.g. motor) with recommendations from Sails provider.
9	1.4.1 Fire in cargo container bay – Vessel General Arrangement	At a later design stage, consider the potential for fire and smoke ingress from surrounding fire (e.g. cargo fire) and potential impact on the sails, air intake for the Fuel Cell room and Battery room, and personnel exposure. Consider operational corrective actions, such as directing the vessel for minimize smoke ingress in the air intake, and consider provider's recommendations.
10	8.2.1 Fuel Cell Room Ventilation - General recommendations documented to improve design 8.2.2 Fuel Cell Room Ventilation - Current location of exhaust gases from Fuel Cell room and expected exhaust gas temperature	Investigate the potential to separate hazardous area zone established by the H <sub>2</sub> supply system from the Fuel Cell system ventilation discharge from safety perspective.
11	8.2.1 Fuel Cell Room Ventilation	Emergency FC/Li-Ion battery HAZID /HAZOP to be conducted at detail design stage



No.	References	Action
12	8.2.1 Fuel Cell Room Ventilation - General recommendations documented to improve design 8.2.2 Fuel Cell Room Ventilation - Current location of exhaust gases from Fuel Cell room and expected exhaust gas temperature	Consider conducting a heat radiation analysis and gas dispersion analysis considering the wind direction and potential impact on sails. The issue discussed is that there is potential for H <sub>2</sub> venting in case of blowdown emergency and catch on fire at the vent mast (e.g. lightning).
13	8.2.3 – Fuel Cell room ventilation - Air inlet to Fuel Cell Room - general recommendation (linked from 5.5)	Determine the Fuel Cell room air inlet location and consider locating the inlet from safe zone
14	11.1.1 General recommendations/question – Sails - . Sail Radius obstruction and interference with hazardous area Zones 1 & 2 (linked from 1.2) 11.19.1 Fire impact on mast – Sails - Fire in H <sub>2</sub> storage bay 11.19.2 Fire impact on mast – Sails - Fire in cargo bay	Investigate the potential impact of surrounding fire (fire in container bay, fire in H <sub>2</sub> storage bay) to the crane and sails system. Conduct fire hazardous analysis and gas dispersion analysis to understand the risk and develop emergency procedures to mitigate the risk. Consult sail provider on the fire resistance or ignition temperature of the sail rig equipment.
15	11.2.1 – Crane Interface – Sail - Overload on the mast, Slew control, slew stops - general recommendations	Investigate crane boom length, boom angles, slew control and verify with mast design load. Also consider applicable cargo gear rules, structural fatigue requirements, and periodic inspections for crane and mast.
16	11.2.1 – Crane Interface – Sail - Overload on the mast, Slew control, slew stops - general recommendations	Since the proposed design is to install the crane on the sail mast, investigate the fatigue cycles of mast rotation unit with crane use.
17	11.2.2 - Crane Interface – Sail – Crane and Sail Collision	Crane/sail collision study to be performed and appropriate control and procedure are to be developed to avoid any collision possibility.
18	11.4.1 Loss of electrical power – electrical fault	Investigate availability of backup power and redundant power supply to the Sails Control system and Mast Rotation Unit considering single failure
19	11.5.1 Vessel Grounding/collision 11.5.2 - Vessel Grounding/collision - Vessel Collision with other vessel 11.6.1 Air Gap – Sails - . Interference with mast when in port (e.g. bridge, cranes, high tension power line)	Conduct a Vessel Collision Study and investigate potential vessel grounding/collision scenarios and the impact on the sails, yards, and masts. Verify the structural integrity of the sails, yards, masts and select the materials accordingly.
20	11.5.1 - Vessel Grounding/collision 11.5.2 - Vessel Grounding/collision - Vessel Collision with other vessel 11.6.1 Air Gap – Sails - . Interference with mast when in port (e.g. bridge, cranes, high tension power line)	Develop vessel operation manual considering the selected ports, port requirements, vessel manoeuvrability and air gap requirement
21	11.5.1 - Vessel Grounding/collision 11.5.2 - Vessel Grounding/collision - Vessel Collision with other vessel	Conduct vessel manoeuvrability study for when vessel is in port without sailing using only auxiliary propulsion system (Fuel Cell, Battery system) and the power requirement.
22	11.6.1 Air Gap – Sails - . Interference with mast when in port (e.g. bridge, cranes, high tension power line)  11.14.1 - Man aloft – Sails - Remote furling system not working 11.14.2 - Man aloft – Sails - Mechanical failure in furling system 11.14.3 – Man aloft – Sail - Maintenance & Inspection (routine)	Consider conducting a Dropped Object Analysis for the entire lifting plan to understand the impact of dropped objects (loose objects such as lifting gear or twist locks or stacking cones, H <sub>2</sub> ISO container, loose damaged mast piece during vessel collision, dropped gear during maintenance when man aloft) onto the H <sub>2</sub> piping & equipment, on other ISO containers below, or the deck during lifting operations. Ensure that there is drop protection and containers, piping, structures are designed such that they can withstand the dropped impact load.
23	11.8.1 - Mast Rotation Unit (MRU) stops responding (Mast unable to rotate) - Failure of mast control system 11.9.1 - out haul winches stop responding - Electrical fault, mechanical failure 11.10.1 - Mandrel drive stops responding - Loss of Primary Power (linked from 11.4) 11.20.1 - Ice build-up on sail mast, spars - vessel operating in freezing conditions	At system level, conduct functional failure analysis (e.g. FMECA study) of the mast control system and investigate different failure modes of mast motors, out haul winches and potential safeguards. Also include the effects of crane slews and controls. Also include potential ice build-up issues
24	11.11.1 - Lightning strike	Investigate potential issues with Lithium-ion battery system in case of a lightning strike.

No.	References	Action
25	11.14.1 – Man Aloft - Remote furling system not working 11.14.2 - Man aloft – Sails - Mechanical failure in furling system 11.14.3 – Man aloft – Sail - Maintenance & Inspection (routine) 14.1.1 - Sails system maintenance/inspection - General recommendations documented to improve design	Develop proper procedures for inspection and maintenance activities and detailed procedures for operator working at height (man aloft). Proper Job Safety Analysis (JSA) and operator training are to be developed
26	11.14.1 – Man Aloft - Remote furling system not working 11.14.2 - Man aloft – Sails - Mechanical failure in furling system 11.14.3 – Man aloft – Sail - Maintenance & Inspection (routine)	Develop vessel procedures and provide appropriate PPE with recommendations from sail provider on emergency procedures for operator injuries, man overboard scenarios, emergency rescue activities.
27	11.14.2 - Man aloft – Sails - Mechanical failure in furling system	Operation manual/procedure to determine the appropriate weather conditions (including wind speed, vessel motion) for safe working conditions in case of emergency
28	11.16.1 Water ingress through bearings, mast openings – Sails - Green water (heavy sea state, splashing seawater onboard) 11.16.2 Water ingress through bearings, mast openings – Sails – Rain Water	Consider providing bilge system to remove water in case of water ingress and accumulation in below deck equipment
29	11.16.1 Water ingress through bearings, mast openings – Sails - Green water (heavy sea state, splashing seawater onboard) 11.16.2 Water ingress through bearings, mast openings – Sails – Rain Water	Sails provider to investigate any possibility of water exposure damaging electrical equipment for the sail system (e.g. bearing damage due to water exposure), and due to the open deck, consider a minimum IP56 electrical rating for electrical equipment
30	11.17.1 - Failure of control systems (wireless and main) - General Recommendation	Remote control and main control for the sails system are to be investigated further in FMECA study and appropriate class requirements and notations are to be considered.
31	11.18.1 - Cybersecurity issues for control system - General recommendations	Consider Cybersecurity class notation for the remote-control functionality of the sail system.
32	11.19.2 - Fire impact on mast - Fire in cargo bay	Develop appropriate emergency escape and rescue (EER) procedures and provide PPE, Life Saving Appliances (LSA) in case of fire in the H <sub>2</sub> storage bay or in the cargo bay leading to smoke inhalation and personnel injury.
33	11.20.1 - Ice build-up on sail mast, spars - vessel operating in freezing conditions	Due to potential for vessel to operate in extreme weather (IACS UR M40 specification for unrestricted ocean surface, in which the outside air temperature can get to -25 degC), investigate potential ice build-up issues and impact on sail mast, vessel stability, and ice build-up falling on vessel equipment. Consider hardware design and material selection.
34	11.20.1 - Ice build-up on sail mast, spars - vessel operating in freezing conditions	Owner/designer to verify vessel class conditions. For example, IACS UR M40 specification for unrestricted ocean surface, in which the outside air temperature can get to -25 degC.
35	12.1.1 - Cargo Lifting Operations - Collision during crane lifting operation due to operator error, inadequate training and procedures	Consider providing collision avoidance system or similar during crane lifting operations to prevent potential crane and load collision
36	12.1.1 - Cargo Lifting Operations - Collision during crane lifting operation due to operator error, inadequate training and procedures	Develop appropriate crane operator training based on crane design, expecting lifting loads, and vessel general arrangement
37	12.1.1 - Cargo Lifting Operations - Collision during crane lifting operation due to operator error, inadequate training and procedures	Develop crane lifting plan and lifting procedures based on crane design & radius, expecting lifting loads, and vessel general arrangement. Also consider safe lifting plan for H <sub>2</sub> ISO containers
38	1.4.1 - Fire in cargo container bay – Vessel General Arrangement	Consider develop cargo restriction protocols and container segregation according to IMDG code and cargo class.

## Appendix IX – HAZID Register Wind Propelled H<sub>2</sub> Assisted Container Carrier

Note: Proprietary information of VEER Group was removed from this report. Therefore, numbering is not continuous.

1	Vessel General Arrangement
---	----------------------------

No.: 1		Vessel General Arrangement								
Item	Deviation	Causes	Consequences	Matrix	Severity	Likelihood	Risk	Safeguards	Recommendations	Comment
1.2	Sail Radius obstruction and interference with hazardous area Zones 1 & 2	1. Sail Radius obstruction and interference with hazardous area Zones 1 & 2. General Recommendations documented from team discussion.	1. Fire and Explosion	Asset	4	C	Extreme		1. Investigate the potential obstruction with sail mast (electrical equipment, 25 motors/sail mast) and the hazardous area Zones from H <sub>2</sub> storage bay and Emergency Power system equipment and any ventilation exhaust or hazardous area exhaust.	- sail to rotate 270 degrees. - consider obstructions or interference with hazardous area zone. - Li-Ion battery room vents require 3 m hazardous zone, with forced ventilation. - Exhaust from H <sub>2</sub> and fuel Cell rooms are vent to aft end of the vessel. - hazardous area (3 m total zone) interfering with sail - 25 motors/sail mast, expected 5 motors in the hazardous zone.

No.: 1		Vessel General Arrangement								
Item	Deviation	Causes	Consequences	Matrix	Severity	Likelihood	Risk	Safeguards	Recommendations	Comment
									<p>2. At a detailed design stage when additional details are available, it is recommended to conduct a Hazard Operability (HAZOP) study to validate design changes, system integration, confirm concept design risk profile maturity, assess additional hazards and ensure safeguards are in place to address hazards. Focus on H<sub>2</sub> storage system to Fuel Cell room and battery ESS system, sail mast obstruction with hazardous area zone established by H<sub>2</sub> storage bay and Emergency Power system, and the hazardous area zones from H<sub>2</sub> storage bay and Emergency Power system equipment and any ventilation exhaust or hazardous area exhaust.</p> <p>3. Provide appropriate PPE and portable detectors for crew working in hazardous area zones.</p>	

No.: 1		Vessel General Arrangement								
Item	Deviation	Causes	Consequences	Matrix	Severity	Likelihood	Risk	Safeguards	Recommendations	Comment
1.3	Crane location & operating radius	1. General recommendations documented to improve design.	1. Collision with other structure, dropped load etc.	Asset	3	C	High		4. Cranes to comply with Lifting Appliances rules and certified per class and regulatory requirements. 5. Interference study and collision study/analysis to be done to understand risk and how to avoid such event	- Assumes crane will be remote control on deck in the vicinity of the crane operations - Potential to have operator cabin up on the mast. - Assumes crane base will be at first yard to avoid interference with containers during crane movement
			2. Equipment/structural damage	Asset	3	C	High			
		2. Collision/interference/operator error	1. Collision with other structure, dropped load etc.	Asset	3	C	High		4. Cranes to comply with Lifting Appliances rules and certified per class and regulatory requirements. 5. Interference study and collision study/analysis to be done to understand risk and how to avoid such event	
			2. Equipment/structural damage	Asset	3	C	High			
1.4	Fire in cargo container bay	1. Cargo container fire on the open deck <b>Comment:</b> - Additional class notations for stronger fire protection of the cargo such as FOC+ for above deck fire protection. - Cargo operation to follow IMDG rules.	1. Damage to surrounding cargo container	Asset	4	C	Extreme	1. Emergency Power Generation equipment installed inside A-60 fire protection boundary 2. Fire, Heat and Smoke detection in cargo container bay	39. Consider develop cargo restriction protocols and container segregation according to IMDG code and cargo class.	

No.: 1		Vessel General Arrangement								
Item	Deviation	Causes	Consequences	Matrix	Severity	Likelihood	Risk	Safeguards	Recommendations	Comment
									<p>7. In case of cargo container fire, the impact on normal power supply and emergency power supply to be studied considering functional failure modes (e.g. FMECA study) to understand the failure modes and impacts.</p> <p>6. Consider the impact of cargo container fire on sails and sail equipment (e.g. motor) with recommendations from Sails provider.</p> <p>9. At a later design stage, consider the potential for fire and smoke ingress from surrounding fire (e.g. cargo fire) and potential impact on the sails, air intake for the Fuel Cell room and Battery room, and personnel exposure. Consider operational corrective actions, such as directing the vessel for minimize smoke ingress in the air intake and consider provider's recommendations.</p>	
			2. Damage to sail mast	Overall	S3-Moderate	LC-Possible	High			
			3. Damage to Emergency Power Generation equipment (FC, Battery)	Asset	3	B	Moderate			
			4. Personnel exposure to smoke	Injury	2	C	Moderate			

No.: 1		Vessel General Arrangement								
Item	Deviation	Causes	Consequences	Matrix	Severity	Likelihood	Risk	Safeguards	Recommendations	Comment
			5. Smoke impact on Fuel Cell system (system uses local air intake)	Asset	3	C	High			
			6. Heating H <sub>2</sub> container (linked to 2.6)							

8	Ventilation system - H <sub>2</sub> storage, FPR, FC, Li-Ion other close spaces
---	---

No.: 8		Ventilation system - H <sub>2</sub> storage, FPR, FC, Li-Ion other close spaces								
Item	Deviation	Causes	Consequences	Matrix	Severity	Likelihood	Risk	Safeguards	Recommendations	Comment
8.2	Fuel Cell Room ventilation	1. General recommendations documented to improve design. <b>Comment:</b> - Fuel Cell Room, with compressed H <sub>2</sub> , may not have air change requirements. - For Fuel Preparation Room and liquid H <sub>2</sub> , there is a 30 air changes/hr. ventilation requirement.	1. Exhaust gas at high temperature impacting Sails	Asset	2	C	Moderate		10. Investigate the potential to separate hazardous area zone established by the H <sub>2</sub> supply system from the Fuel Cell system ventilation discharge from safety perspective.  12. Consider conducting a heat radiation analysis and gas dispersion analysis considering the wind direction and potential impact on sails. The issue discussed is that there is potential for H <sub>2</sub> venting in case of blowdown emergency and catch on fire at the vent mast (e.g. lightning).  11. Emergency FC/Li-Ion battery HAZID /HAZOP to be conducted at detail design stage	
		2. Current location of exhaust gases from Fuel Cell room and expected exhaust gas temperature <b>Comment:</b> - local air intake of Fuel Cell system is sensitive to potential smoke ingress?	1. Exhaust gas at high temperature impacting Sails	Asset	2	C	Moderate		10. Investigate the potential to separate hazardous area zone established by the H <sub>2</sub> supply system from the Fuel Cell system ventilation discharge from safety perspective.	



No.: 8		Ventilation system - H <sub>2</sub> storage, FPR, FC, Li-Ion other close spaces								
Item	Deviation	Causes	Consequences	Matrix	Severity	Likelihood	Risk	Safeguards	Recommendations	Comment
									12. Consider conducting a heat radiation analysis and gas dispersion analysis considering the wind direction and potential impact on sails. The issue discussed there is potential for H <sub>2</sub> venting in case of blowdown emergency and catch on fire at the vent mast (e.g. lightning).	
			2. Sail damage	Asset	2	C	Moderate			
		3. Air inlet to Fuel Cell Room - general recommendation (linked from 5.5)							13. Determine the Fuel Cell room air inlet location and consider locating the inlet from safe zone.	

11	Sails
<ul style="list-style-type: none"> <li>- designed for unrestricted ocean service (North Atlantic sea conditions)</li> <li>- no plan to have active ballast system</li> </ul> <p>Principles:</p> <ul style="list-style-type: none"> <li>- free-standing rotating mast</li> <li>- sail supported by cambered yards</li> <li>- automated sail handling system</li> </ul> <ul style="list-style-type: none"> <li>- Mast Load Monitoring System: fiber optic monitoring system to monitor, gather data from rig (e.g. strain, wind speed, mast rotation angles, allowable torsion, lifetime load data of rig)</li> <li>- bearing/mast rotation unit at the bottom. electrically driven to drive the rotation of the rig, sit on a bearing.</li> <li>- man aloft system</li> <li>- sail setting/furling is partially automated but can be fully automated. takes 1 min to set/furl and full sail plan can set in 6 mins.</li> <li>- sail trimming: rigs can rotate +/-90 deg, time to rotate 180 deg is about 60 sec depending on load levels</li> <li>- bridge control station</li> <li>- wireless remote &amp; mast room: can be used for maintenance purposes</li> <li>- lighting protection system: act as charge dissipation system and is intended to minimize the likelihood of lightning strike</li> <li>- man aloft system: normal operation do not require aloft work but can be done for maintenance/inspection</li> <li>- rig certification: design concept has info on specific load cases, sail handling/reefing sequences, maintenance scheduling, operational manuals, emergency processes, etc.</li> <li>- Sail system can set the sail once the vessel is alongside if the weather is suitable.</li> <li>- splash cover is to minimize water exposure to the rig, water ingress. weather resistance enclosure.</li> </ul>	

No.: 11		Sails								
Item	Deviation	Causes	Consequences	Matrix	Severity	Likelihood	Risk	Safeguards	Recommendations	Comment
11.1	General recommendations/question	1. Sail Radius obstruction and interference with hazardous area Zones 1 & 2 (linked from 1.2)							14. Investigate the potential impact of surrounding fire (fire in container bay, fire in H <sub>2</sub> storage bay) to the crane and sails system. Conduct fire hazardous analysis and gas dispersion analysis to understand the risk and develop emergency procedures to mitigate the risk. Consult sail provider on the fire resistance or ignition temperature of the sail rig equipment.	
11.2	Crane interface	1. Overload on the mast, Slew control, slew stops - general recommendations							15. Investigate crane boom length, boom angles, slew control and verify with mast design load. Also consider applicable cargo gear rules, structural fatigue requirements, and periodic inspections for crane and mast. 16. Since the proposed design is to install the crane on the sail mast, investigate the fatigue cycles of mast rotation unit with crane use.	- two cranes will be installed on the forward mast (hold 1) and mizzen mast (hold 2 & H <sub>2</sub> storage bay)

No.: 11		Sails								
Item	Deviation	Causes	Consequences	Matrix	Severity	Likelihood	Risk	Safeguards	Recommendations	Comment
		2. Crane and Sail collision	2. Damage to Sail and crane	Asset	3	C	High		17. Crane/sail collision study to be performed and appropriate control and procedure are to be developed to avoid any collision possibility.	
			3. Dropped load	Asset	3	C	High			
11.3	Bad weather (high wind speed, high wave)	1. Bad weather (high wind speed, high wave)	1. Vessel overload	Asset	2	C	Moderate	1. Vessel to follow safe marine practices, weather forecasting, route planning 2. Mast Load Monitoring System (MLMS) 3. Crew training 4. Load monitoring 5. Wind speed monitoring & alarms 6. Sail setting sequence 7. Fuel Cell system provides power & Li-Ion battery system provides surge capability/protection to provide constant power supply. Both has redundant systems on port and starboard side.	- Sails designed with safety margins and consider extreme operations in sailing design. Wind tunnel testing, testing in real life situations. - procedure to progressively reduce sails based on rig load or weather conditions. - sailing with nominally 10 degree heel angle. - Sail designer specify primary power, secondary backup power supply in MRU, UPS power supply - potential to rotate the rig to minimize heeling force	

No.: 11		Sails								
Item	Deviation	Causes	Consequences	Matrix	Severity	Likelihood	Risk	Safeguards	Recommendations	Comment
								8. Backup Emergency Power supply with independent Fuel Cell system, Battery system, and H <sub>2</sub> supply. 9. Container are secure in sail guide and in and meet IMDG requirement		
			2. Potential extreme heel angle	Asset	2	C	Moderate			
			3. Damage to sails	Asset	2	B	Low			
			4. Cargo shifts	Asset	2	B	Low			
			5. Vessel capsize	Overall	S5-Critical	LB-Unlikely	Extreme			
			6. Green water effect	Asset	2	C	Moderate			
			7. Mast failure (very low likelihood)	Asset	3	B	Moderate			
			8. Rig Overload (linked to 11.7)							
11.4	Loss of Primary Power	1. Electrical fault	1. Loss of Primary Power (Fuel Cell System)	Asset	2	C	Moderate	1. Backup Emergency Power supply with independent Fuel Cell system, Battery system, and H <sub>2</sub> supply. Backup power will be available in 30-45 seconds (per class rules) to recover the sails system. 2. Manual furling of the sails 3. FC divided in two separate stacks	18. Investigate availability of backup power and redundant power supply to the Sails Control system and Mast Rotation Unit considering single failure.	- normal operations

No.: 11		Sails								
Item	Deviation	Causes	Consequences	Matrix	Severity	Likelihood	Risk	Safeguards	Recommendations	Comment
			2. Loss of sail control system	Asset	3	C	High			
			3. Man aloft (linked to 11.14)							
			4. Mandrel drive stops responding (linked to 11.10)							
			5. Failure of control systems (wireless and main) (linked to 11.17)							
11.5	Vessel Grounding/Collision *	1. Vessel Grounding	1. Vessel damage	Asset	3	C	High	1. Vessel to follow safe marine practices, route planning, port study 2. Mast designed with safety margins for structural integrity 3. Crew training & operation manual 4. Vessel has large keel below hull 5. Local pilot will come onboard from port state to guide vessel manoeuvring in port 6. H <sub>2</sub> piping to meet IGF code requirement	19. Conduct a Vessel Collision Study and investigate potential vessel grounding/collision scenarios and the impact on the sails, yards, and masts. Verify the structural integrity of the sails, yards, masts and select the materials accordingly. 20. Develop vessel operation manual considering the selected ports, port requirements, vessel manoeuvrability and air gap requirement. 21. Conduct vessel manoeuvrability study for when vessel is in port without sailing using only auxiliary propulsion system (Fuel Cell, Battery system) and the power requirement.	- air draft: 63 m - vessel will only require as little tug assistance as possible

No.: 11		Sails								
Item	Deviation	Causes	Consequences	Matrix	Severity	Likelihood	Risk	Safeguards	Recommendations	Comment
			2. Vessel unable to sail (lost days)	Asset	3	B	Moderate			
			3. H <sub>2</sub> leakage from damaged H <sub>2</sub> piping	Asset	3	B	Moderate			
			4. Rig Overload (linked to 11.7)							
		2. Vessel Collision with other vessel	1. Vessel damage	Asset	3	C	High	1. Vessel to follow safe marine practices, route planning, port study 2. Mast designed with safety margins for structural integrity 4. Vessel has large keel below hull 5. Local pilot will come onboard from port state to guide vessel manoeuvring in port	19. Conduct a Vessel Collision Study and investigate potential vessel grounding/collision scenarios and the impact on the sails, yards, and masts. Verify the structural integrity of the sails, yards, masts and select the materials accordingly. 20. Develop vessel operation manual considering the selected ports, port requirements, vessel manoeuvrability and air gap requirement. 21. Conduct vessel manoeuvrability study for when vessel is in port without sailing using only auxiliary propulsion system (Fuel Cell, Battery system) and the power requirement.	
			2. Vessel unable to sail (lost days)	Asset	3	B	Moderate			

No.: 11		Sails								
Item	Deviation	Causes	Consequences	Matrix	Severity	Likelihood	Risk	Safeguards	Recommendations	Comment
11.6	Air Gap	<p>1. Interference with mast when in port (e.g. bridge, cranes, high tension power line)</p> <p><b>Comment:</b> - expected damage is when in port/port area</p> <ul style="list-style-type: none"> <li>- travel in narrow channel port, loch</li> <li>- surrounding topsides cranes</li> <li>- Replacement of removable yard (not integral to mast)</li> </ul>	1. Damage to Sails, Mast, yard (also consider yard replacement cost)	Asset	3	C	High	<p>1. Vessel to follow safe marine practices, route planning, port study</p> <p>2. Crew training &amp; operation manual</p> <p>3. Local pilot will come onboard from port state to guide vessel manoeuvring in port</p>	<p>22. Consider conducting a Dropped Object Analysis for the entire lifting plan to understand the impact of dropped objects (loose objects such as lifting gear or twist locks or stacking cones, H<sub>2</sub> ISO container, loose damaged mast piece during vessel collision, dropped gear during maintenance when man aloft) onto the H<sub>2</sub> piping &amp; equipment, on other ISO containers below, or the deck during lifting operations. Ensure that there is drop protection and containers, piping, structures are designed such that they can withstand the dropped impact load.</p> <p>19. Conduct a Vessel Collision Study and investigate potential vessel grounding/collision scenarios and the impact on the sails, yards, and masts. Verify the structural integrity of the sails, yards, masts and select the materials accordingly.</p>	



No.: 11		Sails								
Item	Deviation	Causes	Consequences	Matrix	Severity	Likelihood	Risk	Safeguards	Recommendations	Comment
									20. Develop vessel operation manual considering the selected ports, port requirements, vessel manoeuvrability and air gap requirement.	
			2. Vessel damage	Asset	3	C	High			
			3. Vessel unable to sail (lost days)	Asset	3	B	Moderate			
			4. Damaged mast piece falling on H <sub>2</sub> containers, H <sub>2</sub> container & H <sub>2</sub> piping damage	Asset	3	C	High			
			5. H <sub>2</sub> leakage from damaged H <sub>2</sub> piping	Overall	S2-Minor	LC-Possible	Moderate			
			6. Rig Overload (linked to 11.7)							
11.7	Rig Overload	1. Bad weather (high wind speed, high wave) (linked from 11.3) 2. Vessel Grounding/Collision * (linked from 11.5) 3. Crane interface (linked from 11.2) 4. Air Gap (linked from 11.6)								See scenario in 11.2 Crane Interface, 11.3 Bad Weather, 11.5 Vessel Grounding/Collision

No.: 11		Sails								
Item	Deviation	Causes	Consequences	Matrix	Severity	Likelihood	Risk	Safeguards	Recommendations	Comment
11.8	Mast Rotation Unit (MRU) stops responding (Mast unable to rotate)	1. Failure of mast control system	1. Unable to rotate the mast	Asset	2	C	Moderate	2. Safe vessel heading (managed by rudder) 3. Furling of sail (take the sail down) 5. Redundancy in Mast Control System and power: at bridge station, wireless, local control at MRU 6. Four motors on each mast, wired independently	23. At system level, conduct functional failure analysis (e.g. FMECA study) of the mast control system and investigate different failure modes of mast motors, out haul winches and potential safeguards. Also include the effects of crane slews and controls. Also include potential ice build-up issues.	-Vessel will have three sail masts, and each mast is designed such that failure is one at a time unless there is a complete vessel blackout
			2. Unable to enter port	Asset	2	C	Moderate			
			3. Unable to do cargo operations	Asset	2	C	Moderate			
		2. Electrical fault <b>Comment:</b> - electrical fault impacting mast motor	1. Unable to rotate the mast	Asset	2	C	Moderate	1. Emergency Power supply with independent Fuel Cell system, Battery system, and H <sub>2</sub> supply. 4. Manual furling of the sail 5. Redundancy in Mast Control System and power: at bridge station, wireless, local control at MRU 6. Four motors on each mast, wired independently		
			2. Unable to enter port	Asset	2	C	Moderate			
			3. Unable to do cargo operations	Asset	2	C	Moderate			

No.: 11		Sails								
Item	Deviation	Causes	Consequences	Matrix	Severity	Likelihood	Risk	Safeguards	Recommendations	Comment
		3. Vessel blackout (total loss of primary power) <b>Comment:</b> - rudder is on emergency power and multiple redundancy on rudder controls.	1. Unable to rotate the mast	Asset	2	C	Moderate	1. Emergency Power supply with independent Fuel Cell system, Battery system, and H <sub>2</sub> supply. 2. Safe vessel heading (managed by rudder) 4. Manual furling of the sail 7. Fuel Cell can power vessel propulsion system		
			2. Unable to enter port	Asset	2	C	Moderate			
			3. Unable to do cargo operations	Asset	2	C	Moderate			
11.9	out haul winches stop responding	1. Electrical fault, mechanical failure	1. Unable to deploy the sails	Asset	2	C	Moderate	1. Redundancy in sail system such that each mast has multiple sail systems	23. At system level, conduct functional failure analysis (e.g. FMECA study) of the mast control system and investigate different failure modes of mast motors, out haul winches and potential safeguards. Also include the effects of crane slews and controls. Also include potential ice build-up issues.	- out haul winches to pull the sails out
			2. Impact on vessel speed and efficiency	Asset	2	C	Moderate			

No.: 11		Sails								
Item	Deviation	Causes	Consequences	Matrix	Severity	Likelihood	Risk	Safeguards	Recommendations	Comment
11.10	Mandrel drive stops responding	1. Loss of Primary Power (linked from 11.4)							23. At system level, conduct functional failure analysis (e.g. FMECA study) of the mast control system and investigate different failure modes of mast motors, out haul winches and potential safeguards. Also include the effects of crane slews and controls. Also include potential ice build-up issues.	- Furling system control, motor, power failure
11.11	Lightning strike	1. Lightning strike	1. Electric shock, fire on sail mast	Asset	3	B	Moderate	1. Vessel safe marine practices 2. Sail system's lighting protection system, which acts as charge dissipation system and is intended to minimize the likelihood of lightning strike 3. Separate wind monitoring system on different sail rigs (redundant wind speed indicators)	24. Investigate potential issues with Lithium-ion battery system in case of a lightning strike.	- sail is composite materials

No.: 11		Sails								
Item	Deviation	Causes	Consequences	Matrix	Severity	Likelihood	Risk	Safeguards	Recommendations	Comment
								4. Auxiliary propulsion available: Fuel Cell system provides power & Li-Ion battery system provides surge capability/protection to provide constant power supply. Both has redundant systems on port and starboard side. 5. Backup Emergency Power supply with independent Fuel Cell system, Battery system, and H <sub>2</sub> supply.		
			2. Structural damage on mast system	Asset	2	B	Low			
			3. Electrical damage on mast system	Asset	2	C	Moderate			
			4. Loss of instrumentation on mast system	Asset	2	C	Moderate			
			5. Loss of sails system	Asset	3	B	Moderate			
11.12	Exposure to Fuel Cell system exhausts	1. No significant risk identified. The expected fuel cell system exhaust maximum temperature is 90 degC, which will not impact the sails since the sail melting point is 267 degC.								- fuel cell system exhaust Tmax: 90 degC, which will not impact the sails since the sail melting point is 267 degC. - abnormal situation

No.: 11		Sails								
Item	Deviation	Causes	Consequences	Matrix	Severity	Likelihood	Risk	Safeguards	Recommendations	Comment
11.13	Exposure to Li-Ion battery thermal runaway exhausts	1. Exposure to Li-Ion battery thermal runaway exhausts	1. Loss of mizzen mast sail	Asset	3	B	Moderate	1. Deck monitor 2. Deck firefighting system	1. Investigate the potential obstruction with sail mast (electrical equipment, 25 motors/sail mast) and the hazardous area Zones from H <sub>2</sub> storage bay and Emergency Power system equipment and any ventilation exhaust or hazardous area exhaust.	- Li-Ion Battery system exhaust Tmax: 700 degC - sail melting point: 267 degC.
11.14	Man aloft	1. Remote furling system not working <b>Comment:</b> - abnormal condition, man aloft to troubleshoot issue with remote furling system	2. Human injury	Injury	3	C	High		22. Consider conducting a Dropped Object Analysis for the entire lifting plan to understand the impact of dropped objects (loose objects such as lifting gear or twist locks or stacking cones, H <sub>2</sub> ISO container, loose damaged mast piece during vessel collision, dropped gear during maintenance when man aloft) onto the H <sub>2</sub> piping & equipment, on other ISO containers below, or the deck during lifting operations. Ensure that there is drop protection and containers, piping, structures are designed such that they can withstand the dropped impact load.	- impact to operator if control system is lock out/tag out - any angle of heel - man aloft due to any causes listed

No.: 11		Sails								
Item	Deviation	Causes	Consequences	Matrix	Severity	Likelihood	Risk	Safeguards	Recommendations	Comment
									25. Develop proper procedures for inspection and maintenance activities and detailed procedures for operator working at height (man aloft). Proper Job Safety Analysis (JSA) and operator training are to be developed. 26. Develop vessel procedures and provide appropriate PPE with recommendations from sail provider on emergency procedures for operator injuries, man overboard scenarios, emergency rescue activities.	
			3. Man overboard	Injury	3	C	High			
			4. Dropped objects (operator working gears)	Overall	S2-Minor	LC-Possible	Moderate			

No.: 11		Sails								
Item	Deviation	Causes	Consequences	Matrix	Severity	Likelihood	Risk	Safeguards	Recommendations	Comment
		2. Mechanical failure in furling system <b>Comment:</b> - abnormal condition, man aloft to troubleshoot mechanical failure in furling system	1. Unable to furl the sail	Asset	2	C	Moderate	1. Vessel safe heading, route planning	22. Consider conducting a Dropped Object Analysis for the entire lifting plan to understand the impact of dropped objects (loose objects such as lifting gear or twist locks or stacking cones, H <sub>2</sub> ISO container, loose damaged mast piece during vessel collision, dropped gear during maintenance when man aloft) onto the H <sub>2</sub> piping & equipment, on other ISO containers below, or the deck during lifting operations. Ensure that there is drop protection and containers, piping, structures are designed such that they can withstand the dropped impact load.  25. Develop proper procedures for inspection and maintenance activities and detailed procedures for operator working at height (man aloft). Proper Job Safety Analysis (JSA) and operator training are to be developed.	



No.: 11		Sails								
Item	Deviation	Causes	Consequences	Matrix	Severity	Likelihood	Risk	Safeguards	Recommendations	Comment
									26. Develop vessel procedures and provide appropriate PPE with recommendations from sail provider on emergency procedures for operator injuries, man overboard scenarios, emergency rescue activities. 27. Operation manual/procedure to determine the appropriate weather conditions (including wind speed, vessel motion) for safe working conditions in case of emergency.	
			2. Human injury	Injury	3	C	High			
			3. Man overboard	Injury	3	C	High			
			4. Dropped objects (operator working gears)	Overall	S2-Minor	LC-Possible	Moderate			

No.: 11		Sails								
Item	Deviation	Causes	Consequences	Matrix	Severity	Likelihood	Risk	Safeguards	Recommendations	Comment
		3. Maintenance & Inspection (routine) <b>Comment:</b> - consider weather conditions when operator conducting regular maintenance & inspection aloft. - Regular periodic maintenance & inspection: inspect fastenings, lights, wind instruments, winches, wear on the sails, fine tune sails connection to mandrel. - Expected inspection monthly, but dependent on sail system conditions - also consider crane inspection.	2. Human injury	Injury	3	C	High		22. Consider conducting a Dropped Object Analysis for the entire lifting plan to understand the impact of dropped objects (loose objects such as lifting gear or twist locks or stacking cones, H <sub>2</sub> ISO container, loose damaged mast piece during vessel collision, dropped gear during maintenance when man aloft) onto the H <sub>2</sub> piping & equipment, on other ISO containers below, or the deck during lifting operations. Ensure that there is drop protection and containers, piping, structures are designed such that they can withstand the dropped impact load.  25. Develop proper procedures for inspection and maintenance activities and detailed procedures for operator working at height (man aloft). Proper Job Safety Analysis (JSA) and operator training are to be developed.	

No.: 11		Sails								
Item	Deviation	Causes	Consequences	Matrix	Severity	Likelihood	Risk	Safeguards	Recommendations	Comment
									26. Develop vessel procedures and provide appropriate PPE with recommendations from sail provider on emergency procedures for operator injuries, man overboard scenarios, emergency rescue activities.	
			3. Man overboard	Injury	3	C	High			
			4. Dropped objects (operator working gears)	Overall	S2-Minor	LC-Possible	Moderate			
		4. Loss of Primary Power (linked from 11.4)								
11.15	Failure of spherical roller deck bearing	1. Mechanical failure of spherical roller deck bearing	1. Unable to rotate mast	Asset	2	C	Moderate	1. Furl all sails on affected mast 2. Auxiliary power supply 3. Enough torque power to overcome the friction 4. Mast Rotation Unit (MRU) amperage monitoring		- located on main deck - crane will also rotate with deck bearing - will cause friction, noise, rotational seizure
11.16	Water ingress through bearings, mast openings	1. Green water (heavy sea state, splashing seawater onboard) <b>Comment:</b> - potential corrosion impact due to salt water exposure?	1. Water ingress through bearings, mast openings	Asset	2	C	Moderate	1. Splash shield/cover for sail system 2. Bearing designed to withstand seawater	28. Consider providing bilge system to remove water in case of water ingress and accumulation in below deck equipment	- potential impact to MRU? - IP56 for open deck - not expecting massive water ingress

No.: 11		Sails								
Item	Deviation	Causes	Consequences	Matrix	Severity	Likelihood	Risk	Safeguards	Recommendations	Comment
									29. Sails provider to investigate any possibility of water exposure damaging electrical equipment for the sail system (e.g. bearing damage due to water exposure), and due to the open deck, consider a minimum IP56 electrical rating for electrical equipment.	
			2. Potential damage, water accumulation in below deck equipment	Asset	2	C	Moderate			
			3. Electrical short-circuiting	Asset	2	C	Moderate			
		2. Rainwater	1. Water ingress through bearings, mast openings	Asset	2	C	Moderate	1. Splash shield/cover for sail system 2. Bearing designed to withstand seawater	28 Consider providing bilge system to remove water in case of water ingress and accumulation in below deck equipment 29. Sails provider to investigate any possibility of water exposure damaging electrical equipment for the sail system (e.g. bearing damage due to water exposure), and due to the open deck, consider a minimum IP56 electrical rating for electrical equipment.	

No.: 11		Sails								
Item	Deviation	Causes	Consequences	Matrix	Severity	Likelihood	Risk	Safeguards	Recommendations	Comment
			2. Potential damage, water accumulation in below deck equipment	Asset	2	C	Moderate			
			3. Electrical short-circuiting	Asset	2	C	Moderate			
		3. Water condensation on the deck floor - no significant issues outside of normal housekeeping activities which is normal in industry.								
11.17	Failure of control systems (wireless and main)	1. General Recommendation							30. Remote control and main control for the sails system are to be investigated further in FMECA study and appropriate class requirements and notations are to be considered.	- main control panel in bridge station is master - wireless control is spare, for maintenance operations or when vessel is in port - interface interlock system
		2. Mast Rotation Unit (MRU) stops responding (Mast unable to rotate) (linked from 11.8)								
		3. out haul winches stop responding (linked from 11.9)								
		4. Loss of Primary Power (linked from 11.4)								
11.18	Cybersecurity issues for control system	1. General recommendations							31. Consider Cybersecurity class notation for the remote-control functionality of the sail system.	

No.: 11		Sails								
Item	Deviation	Causes	Consequences	Matrix	Severity	Likelihood	Risk	Safeguards	Recommendations	Comment
11.19	Fire impact on mast	1. Fire in H <sub>2</sub> storage bay	1. Overheating the sail mast	Asset	2	C	Moderate	2. Fire & gas, smoke detection in H <sub>2</sub> storage bay, cargo bay 3. Water Spray system in H <sub>2</sub> storage bay, cargo bay 4. Emergency Escape & Rescue (EER) procedures for personnel safety	14. Investigate the potential impact of surrounding fire (fire in container bay, fire in H <sub>2</sub> storage bay) to the crane and sails system. Conduct fire hazardous analysis and gas dispersion analysis to understand the risk and develop emergency procedures to mitigate the risk. Consult sail provider on the fire resistance or ignition temperature of the sail rig equipment.	- potential fire from cargo hold or H <sub>2</sub> storage bay - sail is composite material with some fire resistance - in case of surrounding fire immediately shutdown crane operation
			2. Damage to sail mast, mast falling over	Asset	3	C	High			
			3. Damage to crane	Asset	2	C	Moderate			
		2. Fire in cargo bay	1. Overheating the sail mast	Asset	2	C	Moderate	1. Cargo stowage procedures to prevent cargo fire 2. Fire & gas, smoke detection in H <sub>2</sub> storage bay, cargo bay 3. Water Spray system in H <sub>2</sub> storage bay, cargo bay 4. Emergency Escape & Rescue (EER) procedures for personnel safety	14. Investigate the potential impact of surrounding fire (fire in container bay, fire in H <sub>2</sub> storage bay) to the crane and sails system. Conduct fire hazardous analysis and gas dispersion analysis to understand the risk and develop emergency procedures to mitigate the risk. Consult sail provider on the fire resistance or ignition temperature of the sail rig equipment.	

No.: 11		Sails								
Item	Deviation	Causes	Consequences	Matrix	Severity	Likelihood	Risk	Safeguards	Recommendations	Comment
									32. Develop appropriate emergency escape and rescue (EER) procedures and provide PPE, Life Saving Appliances (LSA) in case of fire in the H <sub>2</sub> storage bay or in the cargo bay leading to smoke inhalation and personnel injury.	
			2. Damage to sail mast, mast falling over	Asset	3	C	High			
			3. Damage to crane	Asset	2	C	Moderate			
11.20	Ice build-up on sail mast, spars	1. vessel operating in freezing conditions	1. Ice build-up on sail mast	Asset	2	D	High		23. At system level, conduct functional failure analysis (e.g. FMECA study) of the mast control system and investigate different failure modes of mast motors, out haul winches and potential safeguards. Also include the effects of crane slews and controls. Also include potential ice build-up issues.	<ul style="list-style-type: none"> <li>- de-icing?</li> <li>- vessel will work in ice free ports but vessel operating envelope may still include freezing conditions</li> <li>- potential ice build-up, jamming the sail furling</li> <li>- IACS UR M40 specification for unrestricted ocean surface, in which the outside air temperature can get to -25 degC. (ABS Marine Vessel Rules 4-1-1, Table 8)</li> </ul>

No.: 11		Sails								
Item	Deviation	Causes	Consequences	Matrix	Severity	Likelihood	Risk	Safeguards	Recommendations	Comment
									<p>33. Due to potential for vessel to operate in extreme weather (IACS UR M40 specification for unrestricted ocean surface, in which the outside air temperature can get to -25 degC), investigate potential ice build-up issues and impact on sail mast, vessel stability, and ice build-up falling on vessel equipment. Consider hardware design and material selection.</p> <p>34. Owner/designer to verify vessel class conditions. For example, IACS UR M40 specification for unrestricted ocean surface, in which the outside air temperature can get to -25 degC.</p>	
			2. Impact on vessel stability	Asset	2	C	Moderate			
			3. Ice build-up falling on vessel equipment	Asset	2	C	Moderate			



12	Cargo loading/unloading operations
----	------------------------------------

No.: 12		Cargo loading/unloading operations								
Item	Deviation	Causes	Consequences	Matrix	Severity	Likelihood	Risk	Safeguards	Recommendations	Comment
12.1	Cargo Lifting Operations	1. Collision during crane lifting operation due to operator error, inadequate training and procedures	1. Dropped objects during lifting operation	Asset	2	C	Moderate	1. Lifting appliances and cranes to be certified and inspected 2. Vessel to follow safe lifting practices	58. Consider providing collision avoidance system or similar during crane lifting operations to prevent potential crane and load collision.  35. Develop appropriate crane operator training based on crane design, expecting lifting loads, and vessel general arrangement.  36. Develop crane lifting plan and lifting procedures based on crane design & radius, expecting lifting loads, and vessel general arrangement. Also consider safe lifting plan for H <sub>2</sub> ISO containers.	
			2. Damage to cargo containers	Asset	2	C	Moderate			
			3. Damage to H <sub>2</sub> ISO Containers	Asset	4	B	High			
			4. Damage to Sail Yards	Asset	2	C	Moderate			
			5. Damage to other cranes and mast	Asset	3	C	High			
			6. Human injury	Injury	3	B	Moderate			

14	Maintenance & Inspection
----	--------------------------

No.: 14		Maintenance & Inspection								
Item	Deviation	Causes	Consequences	Matrix	Severity	Likelihood	Risk	Safeguards	Recommendations	Comment
14.1	Sails system maintenance/inspection	1. General recommendations documented to improve design.							94. Develop proper procedures for inspection and maintenance activities and detailed procedures for operator working at height (man aloft). Proper Job Safety Analysis (JSA) and operator training are to be developed.	
		2. Man aloft - Sails (linked from 11.14)								

## Appendix X – Detailed Regulatory Gap Analysis

No Gap or Changes needed to address ammonia
Small Gap or Minor Change to address ammonia
Medium Gap or Some Challenging Change to address WAPS
Large Gap or Many Challenging Changes to address WAPS

Subject	Code	Comment on Code/Standard-Benefits	Comment on Code/Standard – Gaps	General Comments	Contribute/Restrain uptake of WAPS
EEDI	IMO: MARPOL Annex VI	- Introduces the IMO's regulatory framework for air pollution and key air-pollutant controls for shipping.	- Regulation 22/23 of MARPOL Annex VI requires the attained EEDI/EEXI to be calculated. - Regulation 24/25 of MARPOL Annex VI provides EEDI/EEXI requirements. - Hybrid definition is unclear	A practical methodology for evaluating the contribution of WAPS to the EEDI/EEXI is needed.	<u>Contribute.</u> The regulations for the EEDI/EEXI requirements give drive to the industry for the adoption of WAPS as WAPS contributes to the reduction of greenhouse gas emission.
	IMO: The 2022 Guidelines on the method of calculation of the attained energy efficiency design index (EEDI) for new ships, Resolution MEPC.364(79)	- Provides EEDI calculation methods for new ships.	- Focus on the method of calculating the attained EEDI.		
	IMO: The 2021 Guidance on Treatment of Innovative Energy Efficiency Technologies for Calculation and Verification of the Attained EEDI and EEXI, Resolution MEPC.1/Circ 896	- Provides guidelines to consider the innovative energy efficiency technologies in the attained EEDI and EEXI calculation.	- Focuses on the method of treating innovative energy efficiency technologies for calculation and verification of the attained EEDI/EEXI. - It is recommended to improve the guidance in several aspects to better assess the contribution of WAPS to EEDI/EEXI such as the determination of wind force matrix, use of wind-probability matrix, and sea trial verification method.		
	IMO: The 2022 Guidelines on Survey and Certification of the Energy Efficiency Design Index (EEDI), Resolution MEPC.365(79)	- Provides guidelines to assist verifiers of the EEDI of ships in conducting the survey and certification of the EEDI, in accordance with regulations 5, 6, 7, 8 and 9 of MARPOL Annex VI.	- Focus on the survey and verification of EEDI. - Do not consider the impact of WAPS into the verification procedure.		

Subject	Code	Comment on Code/Standard-Benefits	Comment on Code/Standard – Gaps	General Comments	Contribute/Restrain uptake of WAPS
	Ships and marine technology — Guidelines for the assessment of speed and power performance by analysis of speed trial data, ISO 15016:2015	<ul style="list-style-type: none"> <li>- Defines and specifies the procedures for the preparation, execution, analysis and reporting of speed trials for ship.</li> </ul>	<ul style="list-style-type: none"> <li>- Focus on the procedures to be applied in the preparation, execution, analysis and reporting of speed trials for ships.</li> <li>- It is difficult to use the existing procedure to evaluate the performance of ships with WAPS during sea trials.</li> <li>- It is recommended to develop standardised methodology for full-scale evaluation of ships with WAPS based on the existing ISO standard.</li> </ul>		
Regulations for EU Member States	Fuel EU Maritime	<ul style="list-style-type: none"> <li>- Economic incentives for positive change or to adopt WAPS.</li> </ul>	<ul style="list-style-type: none"> <li>- Focus on increasing the demand for renewable and low-carbon fuels for ships sailing to and from EU ports</li> <li>- The focus is on well-to-wake emissions.</li> <li>- Credits are given for WAPS based on EEDI methodology</li> </ul>	International regulators are pivoting to adopt more stringent emissions regulations to reduce the impacts to climate change. Various efforts in the European Union to adopt more renewable energy sources throughout its industrial and transportation markets can include the increased use of renewable sources. Although WAPS is not recognised as a renewable energy and power source under RED, it is recognised as an effective way to reduce emissions.	<p><u>Contribute.</u></p> <p>The regulations force industries to look to renewable solutions or face consequences by using or continuing to use polluting fuels.</p>
	EU Emissions Trading System (ETS)	<ul style="list-style-type: none"> <li>- Economic incentives for positive change or to adopt WAPS.</li> </ul>	<ul style="list-style-type: none"> <li>- Set a limit on the yearly maximum amount of GHG emissions and the trading of EU emission allowances.</li> <li>- Only focused on tank-to-wake emissions</li> <li>- WAPS is considered implicitly resulting in lower fuel consumption</li> </ul>		
	EU Energy Taxation Directive	<ul style="list-style-type: none"> <li>- Economic incentives for positive change or to adopt WAPS.</li> </ul>	<ul style="list-style-type: none"> <li>- Maritime sector fully exempts so far.</li> <li>- Proposals for maritime sector to be included is in place.</li> <li>- Member states independently implement national policy.</li> </ul>		
	EU RED	<ul style="list-style-type: none"> <li>- Supports renewable sources.</li> <li>- Economic incentives for positive change or to adopt WAPS.</li> </ul>	<ul style="list-style-type: none"> <li>- Divided incentives for shipowners and operators do not stimulate the deployment of renewable sources.</li> <li>- Wind propulsion has not been included in the list of renewable energy and power sources under the RED.</li> <li>- Member states independently implement national policy</li> </ul>		
Stability	IMO International Code on Intact Stability, Resolution MSC.267(85)	<ul style="list-style-type: none"> <li>- Presents mandatory and recommendatory stability criteria and other measures for ensuring the safe operation of ships, to minimise the risk of such ships, to personnel on board and to the environment.</li> </ul>	<ul style="list-style-type: none"> <li>- Provides requirements of intact stability for several types of ships and marine vehicles.</li> <li>- Does not consider the impact of WAPS to the stability requirements.</li> <li>- The criteria in the Code may not work for ships with WAPS.</li> </ul>	WAPS has impact on the stability of ships.	<p><u>Contribute.</u></p> <p>The stability requirements ensure the safe operation of ships with WAPS.</p>

Subject	Code	Comment on Code/Standard-Benefits	Comment on Code/Standard – Gaps	General Comments	Contribute/Restrain uptake of WAPS
	Interim Guidelines on the Second-Generation Intact Stability Criteria (MSC.1-Circ.1627).	- Provides performance-based criteria to address the problems related to dynamic stability failures in view of a wide variety of ship types, sizes, operational profiles and environmental conditions.	- The criteria in the report may not work for ships with WAPS.		
	IMO SOLAS II-1	- Provides requirements of intact stability and damage stability for passenger ships and cargo ships.	- Provides requirements of intact stability and damage stability for passenger ships and cargo ships. - The criteria in the Code may not work for ships with WAPS.		
	IMO Resolution MSC.429 (98)	- Provides explanatory notes to the SOLAS Chapter II-1.	- Provides interpretation to SOLAS Chapter II-1.		
Manoeuvrability and course keeping	IMO Standards for Ship Manoeuvrability, Resolution MSC 137 (76)	- Provides guidelines and requirements to evaluate the manoeuvring performance of ships.	- Focuses on ships with conventional propulsion system and does not consider the impact of WAPS to ship manoeuvrability and course keeping.	WAPS has impact the manoeuvrability of ships.	<u>Contribute.</u> The manoeuvrability requirements ensure the safe operation of ships with WAPS.
MPP	IMO Guidelines for determining minimum propulsion power to maintain the manoeuvrability of ships in adverse conditions, Resolution MEPC Circ.850	- Specifies the minimum power requirement to maintain the manoeuvrability of ships in adverse conditions	- Focuses on the method to determine the MPP for maintaining the manoeuvrability of tankers, bulk carrier and combination carriers in adverse conditions. - It would be beneficial to develop a uniform methodology to calculate both the EEDI and MPP.	A uniform methodology to calculate MPP is needed.	<u>Contribute.</u> The MPP requirements ensure the safe operation of ships with WAPS.
Bridge visibility and safety of navigation	IMO Revised Performance Standards, Resolution MSC.192(79)	- Aims to unify the general maritime radar regulations, especially for display and presentation of navigation-related information.	- Provide requirements of radar equipment. - Does not consider the impact of large sail areas which may cause radar blind sectors. - It is recommended to develop specific guidelines for using alternative methods to address the larger blind sectors caused by the WAPS to radar.	A specific guideline for navigation safety is needed for ships with WAPS which allow using alternative methods to compensate the larger blind spots caused by WAPS.	<u>Restrain.</u> Some types of WAPS which have large sail areas that may affect the ship's ability to meet the requirements in the guidelines.

Subject	Code	Comment on Code/Standard- Benefits	Comment on Code/Standard – Gaps	General Comments	Contribute/Restrain uptake of WAPS
	IMO SOLAS V	<ul style="list-style-type: none"> <li>- Provides requirements for navigation safety</li> </ul>	<ul style="list-style-type: none"> <li>- Regulation 19/2.7 provides requirements regarding radar systems and blind sectors.</li> <li>- Reg 22 provides detailed requirements for navigation bridge visibility.</li> <li>- Regulation 22/3 leaves special consideration open for “unconventional design.</li> <li>- Does not consider the impact of large sail areas which may cause larger blind sectors than required.</li> <li>- It is to be demonstrated that the vessel with the wind-assisted propulsion system deployed satisfies the requirements under SOLAS Chapter V.</li> <li>- Where compliance is impractical, alternatives will be considered on a case-by-case basis in association with the Flag Administration.</li> <li>- It is recommended to develop specific guidelines for using alternative methods to address the larger blind sectors caused by the WAPS.</li> </ul>		
	IMO Guidelines for the Installation of Shipborne Radar Equipment, SN1/Circ.271	<ul style="list-style-type: none"> <li>- Provides guidelines to ensure the correct installation of the radar equipment</li> </ul>	<ul style="list-style-type: none"> <li>- Some types of WAPS which have a large sail area may affect the ships to meet the requirements in guidelines.</li> </ul>		
	IMO Convention on the International Regulations for Preventing Collisions at Sea 1972 (COLREG 72)	<ul style="list-style-type: none"> <li>- Provides detailed requirements for the types and locations of the navigational lights that are to be installed on the ships.</li> <li>- Provides alternative solutions when the first principle method is not practical, including the addition of masthead lighting and all-round lighting.</li> </ul>	<ul style="list-style-type: none"> <li>- Provides detailed specification for the types and locations of the navigational lights that are required to be installed on the vessel.</li> <li>- It is recommended to develop specific guidelines for using alternative methods to address the larger blind spots caused by the WAPS to navigation lights.</li> </ul>		
Structure	IACS Classification Societies Rules	<ul style="list-style-type: none"> <li>- Class Rule requirements for WAPS.</li> </ul>	<ul style="list-style-type: none"> <li>- It is recommended to develop a comprehensive guideline to provide customised requirements for load determination of different types of WAPS.</li> </ul>	It should be evaluated whether class societies need to create a UR to cover some key aspects for WAPS, including loads, materials, electrical	<u>Contribute.</u> The Class Rules for WAPS provide guidelines and facilitate the adoption of the technology, although they still
Materials	IACS Classification Societies Rules	<ul style="list-style-type: none"> <li>- Class Rule requirements for WAPS.</li> </ul>	<ul style="list-style-type: none"> <li>- It is recommended to include the certification of the materials for various types of WAPS.</li> </ul>		

Subject	Code	Comment on Code/Standard-Benefits	Comment on Code/Standard – Gaps	General Comments	Contribute/Restrain uptake of WAPS
Mooring equipment	IACS Classification Societies Rules	- Class Rule requirements for WAPS.	- No significant gaps for application to ships with WAPS.	systems, crew safety, lightning protection, survey and testing, etc.	need refinements in several aspects, such as load consideration.
Electrical systems, machinery, control systems	IACS Classification Societies Rules	- Class Rule requirements for WAPS.	- No significant gaps for application to ships with WAPS.		
Fire safety and installations in hazardous areas	IACS Classification Societies Rules	- Class Rule requirements for WAPS.	- No significant gaps for application to ships with WAPS.		
	SOLAS II-2	- Provides requirements for fire protection, fire detection and fire extinction.	- No significant gaps for application to ships with WAPS.		
Crew safety	IACS Classification Societies Rules	- Class Rule requirements for WAPS.	- No significant gaps for application to ships with WAPS.		
Lightning protection	IACS Classification Societies Rules	- Class Rule requirements for WAPS.	- No significant gaps for application to ships with WAPS.		
Survey, testing and certification	IACS Classification Societies Rules	- Class Rule requirements for WAPS.	- It is recommended to develop standardised testing procedure for structure integrity and performance assessment of the WAPS.		
Helicopter safety	CAP 437 Standards for offshore helicopter landing areas	- Provides criteria of helicopter offshore landing areas applied by the UK CAA for helicopters registered in the UK.	- It is recommended to assess the impact of WAPS to the necessary helicopter landing area.	WAPS may impact the necessary helicopter-landing area.	<u>Contribute.</u> The requirements ensure the ships with WAPS have sufficient landing areas for helicopters.

**European Maritime Safety Agency**

Praça Europa 4  
1249-206 Lisbon, Portugal  
Tel +351 21 1209 200  
Fax +351 21 1209 210  
[ems.europa.eu](http://ems.europa.eu)

