



Bundesstelle für Seeunfalluntersuchung
Federal Bureau of Maritime Casualty Investigation
Federal Higher Authority subordinated to the Federal Ministry
for Digital and Transport

Investigation Report 23/20

Less Serious Marine Casualty

**Cargo-related accident
(loss of two mobile cranes)
on the
JUMBO VISION
at berth in the port of Rostock
on 31 January 2020**

21 December 2021

This investigation was conducted in conformity with the Law to improve safety of shipping by investigating marine casualties and other incidents (Maritime Safety Investigation Law – SUG). According to said Law, the sole objective of this investigation is to prevent future accidents. This investigation does not serve to ascertain fault, liability or claims (Article 9(2) SUG).

This report should not be used in court proceedings or proceedings of the Maritime Board. Reference is made to Article 34(4) SUG.

The German text shall prevail in the interpretation of this investigation report.

Issued by:
Bundesstelle für Seeunfalluntersuchung – BSU
(Federal Bureau of Maritime Casualty Investigation)
Bernhard-Nocht-Str. 78
D-20359 Hamburg



Director: Ulf Kaspera
Phone: +49 40 3190 8300
posteingang@bsu-bund.de

Fax: +49 40 3190 8340
www.bsu-bund.de

Table of Amendments

Page	Amendment	Date

Table of Contents

1	SUMMARY	8
2	FACTUAL INFORMATION	10
2.1	Photograph of the ship	10
2.2	Ship particulars	10
2.3	Voyage particulars	11
2.4	Marine casualty information	11
2.5	Shore authority involvement and emergency response	13
3	COURSE OF THE ACCIDENT AND INVESTIGATION	14
3.1	Course of the accident	14
3.1.1	Events prior to the accident	14
3.1.2	Events during the accident	19
3.2	Consequences of the accident	20
3.2.1	Environmental pollution	21
3.2.2	Damage to the ship	21
3.2.3	Salvage of the cranes	24
3.3	Subsequent events	25
3.4	Investigation	26
3.4.1	Basic findings	26
3.4.1.1	Heavy-lift vessel JUMBO VISION	26
3.4.1.2	Liebherr LHM 550	26
3.4.1.3	Personnel involved in the accident	30
3.4.1.4	Survey of the scene of the accident	30
3.4.2	Hypothesis 1: Unreliable radio link	32
3.4.2.1	Radio signal switchover	32
3.4.2.2	Loss of radio signal	32
3.4.3	Hypothesis 2: Malfunction	32
3.4.4	Hypothesis 3: Operating error	33
3.4.4.1	Data chips	33
3.4.5	Hypothesis 4: Adverse weather conditions	38
3.4.5.1	Report by Germany's National Meteorological Service (DWD)	38
3.4.5.2	Expert report on the coefficient of friction	38
3.4.6	Hypothesis 5: Pre-existing heel to seaward side	39
3.4.6.1	Demonstration of a ballast operation	39
3.4.6.2	Inclination of crane vs. inclination of ship	39
3.4.6.3	Surveillance cameras	41
3.4.7	Hypothesis 6: Collision with the ship's own cargo-handling gear	44
3.4.7.1	Surveillance cameras	44
3.4.7.2	VDR microphones	45

3.4.8	Hypothesis 7: Influence of stability and rolling behaviour	46
3.4.8.1	Surveillance cameras	46
3.4.8.2	VDR microphones.....	49
3.4.8.3	Data chips.....	51
3.4.8.4	Expert report on the JUMBO VISION's stability and rolling behaviour.....	54
3.4.9	Hypothesis 8: Driven wheelset spinning / wheelslip	61
3.4.9.1	Expert report on the characteristics of the LHM 550's hydraulic drive unit.....	61
3.4.10	Hypothesis 9: Inadequate communication.....	64
4	ANALYSIS.....	65
4.1	Stability	65
4.1.1	Movement sequence	65
4.1.2	Roll oscillation	65
4.1.3	Stability management.....	66
4.2	Crane drive	66
4.3	Steel plates on deck	66
4.4	Communication.....	67
5	CONCLUSIONS	68
6	ACTIONS ALREADY TAKEN.....	70
7	SAFETY RECOMMENDATIONS	71
7.1	Federal Ministry of Transport and Digital Infrastructure (BMVI).....	71
7.1.1	Outfitting requirement: electronic precision inclinometers	71
7.1.2	VDR recordings of roll angles, periods, and accelerations	71
7.2	Jumbo Shipping Co SA	71
7.2.1	Revision of internal procedures relating to the preliminary planning of loading conditions.....	71
7.2.2	Revision of internal procedures relating to communication between ships and personnel responsible for load planning.....	72
7.2.3	Revision of the risk assessments for the movement of cranes on deck.....	72
7.3	Liebherr-MCCtec Rostock GmbH	72
7.3.1	Communication of data relevant to shipment	72
8	SOURCES.....	73
9	ANNEXES	74

Table of Figures

Figure 1: Photograph of the ship	10
Figure 2: Navigational chart: Rostock overseas port, overview	12
Figure 3: Detail: Rostock overseas port, berth 25.....	12
Figure 4: Liebherr LHM 550 ready for use.....	14
Figure 5: Steel plates laid out on deck.....	15
Figure 6: Crane 2 being tandem lifted	16
Figure 7: Stabilising pontoon in the water.....	17
Figure 8: View from the deck looking towards the stern after the two cranes were loaded.....	18
Figure 9: Schematic: Position of the cranes on deck just before the accident	19
Figure 10: Stowage plan: Final stowage positions.....	19
Figure 11: Damage to deck passageway, oil slick	22
Figure 12: Damage to port-side deck passageway caused by crane 1	23
Figure 13: Damage to port-side deck passageway caused by crane 2	23
Figure 14: Three-dimensional image of the surveyed harbour basin bottom with damaged cranes.....	24
Figure 15: The HEBO LIFT salvaging one of the LHM 550s.....	25
Figure 16: The JUMBO VISION on the day of the inspection by the BSU.....	26
Figure 17: LHM 550 running gear.....	27
Figure 18: Crane 2 with double supporting pad.....	29
Figure 19: Position of the steel plates on deck after the accident.....	31
Figure 20: Summary: positioning and sensor signals of crane 2 in the minute leading up to the accident	35
Figure 21: Detail: Crane 2 running gear actuation	37
Figure 22: Loading of LHM 550 cranes on the following voyage (view of deck area).....	40
Figure 23: Loading of LHM 550 cranes on the following voyage (view of horizon) ...	40
Figure 24: Screenshot: surveillance camera directly before accident.....	42
Figure 25: Screenshot: surveillance camera showing crane 2 falling	42
Figure 26: Screenshot: surveillance camera showing crane 1 plunging	42
Figure 27: Screenshot: second surveillance camera before accident.....	43
Figure 28: Surveillance camera positions in relation to berth 25	43
Figure 29: Screenshot: surveillance camera, shortly before slewing of ship's own cargo-handling gear.....	44

Figure 30: Screenshot: surveillance camera, after slewing of ship's own cargo-handling gear	44
Figure 31: Photogrammetry: Heeling to landward side due to slewing of the ship's own cargo-handling gear	45
Figure 32: Photogrammetrically determined heeling angles	47
Figure 33: Photogrammetry: t_0 and t_4 comparison	48
Figure 34: Roll angle over time according to all three measurement methods	49
Figure 35: Visualisation of the two relevant VDR audio files	50
Figure 36: Detail: Inclination, master switch signal, calculated travelled distance	52
Figure 37: Simulation: Moments acting on the ship and resulting roll angles	57
Figure 38: Roll angle over time according to all three measurement methods plus simulation values	58

1 SUMMARY

On 30 January 2020, the heavy-lift vessel JUMBO VISION was at berth in the overseas port of Rostock. During the course of this and the following day, two Liebherr LHM 550 mobile harbour cranes were loaded onto the ship's hatch covers, one after the other. The ship's own cargo-handling gear was used in tandem operation to achieve this.

By about 2045¹ on 31 January, the stabilising pontoons² had been hauled in. The aft crane's wheelsets were swivelled in a transverse direction. For various reasons, this crane had to be moved a short distance towards the seaward side. At first it was accidentally started up in the wrong direction, before the mistake was noticed and it was moved in the required direction.

After the crane had been moved by a few centimetres, it had to be stopped because of an obstacle. Despite the use of various operating commands (stop, reverse, etc.), it was not possible to bring it to a standstill. Without any apparent response, the crane rolled off the hatch and subsequently fell into the harbour basin. Due to the heavy list that this caused, the forward crane also slid into the water immediately afterwards.

The JUMBO VISION sustained minor damage, mainly to the fittings and railing of the water-side deck passageway. The two LHM 550s were salvaged about a month later. Up until then, the harbour basin concerned was closed, fully at first and later partially. There was minor water pollution due to escaping operating fluids.

The BSU's investigators were presented with various possible hypotheses as to why the crane had apparently not responded to the operating commands. These hypotheses were worked through one after the other and largely disproved. Ultimately, a combination of several factors proved responsible for the accident.

An expert stability report demonstrated that the starting and braking movements triggered an amplifying roll oscillation of the entire ship. The movement of the crane to the seaward side coincided with a rolling motion in the same direction.

An expert report on the hydraulic drive of the LHM 550 revealed that at least one of the driving wheelsets of the crane that fell first began to slip and spin, due to which the crane was unable to transmit its drive power to the surface underneath it.

A communication deficit concerning all involved parties further contributed to the accident.

¹ All times in this report are local time (CET = UTC + 1).

² When lifting heavy cargo, water-filled and partly submerged stabilising pontoons are rigidly attached to the ship, in order to increase the waterplane area (and thus the lateral inertia moment and the stability). Although this is often mistakenly assumed, they do not create additional anti-heeling ballast capacity.

The report closes with a number of safety recommendations, including possible outfitting requirements with electronic precision inclinometers for ships of 3,000 GT and above.

2 FACTUAL INFORMATION

2.1 Photograph of the ship

Source: Hasenpusch Photo-Productions



Figure 1: Photograph of the ship

2.2 Ship particulars

Name of ship:	JUMBO VISION
Type of ship:	Heavy-lift vessel
Flag:	Netherlands
Port of registry:	Rotterdam
IMO number:	9153642
Call sign:	PBBG
Operator:	Jumbo Shipping Co SA
Owner:	Jumbo Vision B. V.
Year built:	2000
Shipyard:	Madenci Gemi Sanayi Ltd. Sti., Turkey
Classification society:	Lloyd's Register
Length overall:	110.49 m
Breadth overall:	20.72 m
Draught (max.):	7.70 m
Gross tonnage:	7,966
Deadweight:	6,993 t
Engine rating:	4,900 kW
Main engine:	MAN B&W 7S35MC
Cargo-handling gear:	2x Huisman, each with a SWL of 400 t
(Service) Speed:	15.9 kts
Hull material:	Steel
Hull design:	Reinforced for heavy cargoes; double bottom

2.3 Voyage particulars

Port of departure:	Rostock, Germany
Next port of call:	Apapa (Lagos), Nigeria
Type of voyage:	Commercial shipping, international
Cargo information:	Mixed heavy-lift and general cargo in the cargo hold, two harbour cranes on deck
Crew:	15
Draught at time of accident:	$D_f = 7.45$ m, $D_m = 7.65$ m, $D_a = 7.87$ m
Pilot on board:	No
Number of passengers:	None

2.4 Marine casualty information

Type of marine casualty:	Less serious marine casualty; deck cargo falling overboard
Date, time:	31 January 2020, 2050 hrs
Location:	Overseas port of Rostock, harbour basin B, berth 25
Latitude/Longitude:	$\varphi = 54^{\circ}09'$ N, $\lambda = 012^{\circ}07'$ E
Voyage segment:	At berth, made fast alongside
Place on board:	on deck
Consequences:	<ul style="list-style-type: none">– one person with minor injuries, one person in a state of shock,– minor damage to ship,– total loss of both mobile cranes,– harbour basin fully closed until 8 February 2020 and partially closed until 10 March 2020,– minor water pollution due to escaping operating fluids.

Section of Navigational Chart INT 1355,
 German Federal Maritime and Hydrographic Agency (BSH) chart no. 1672

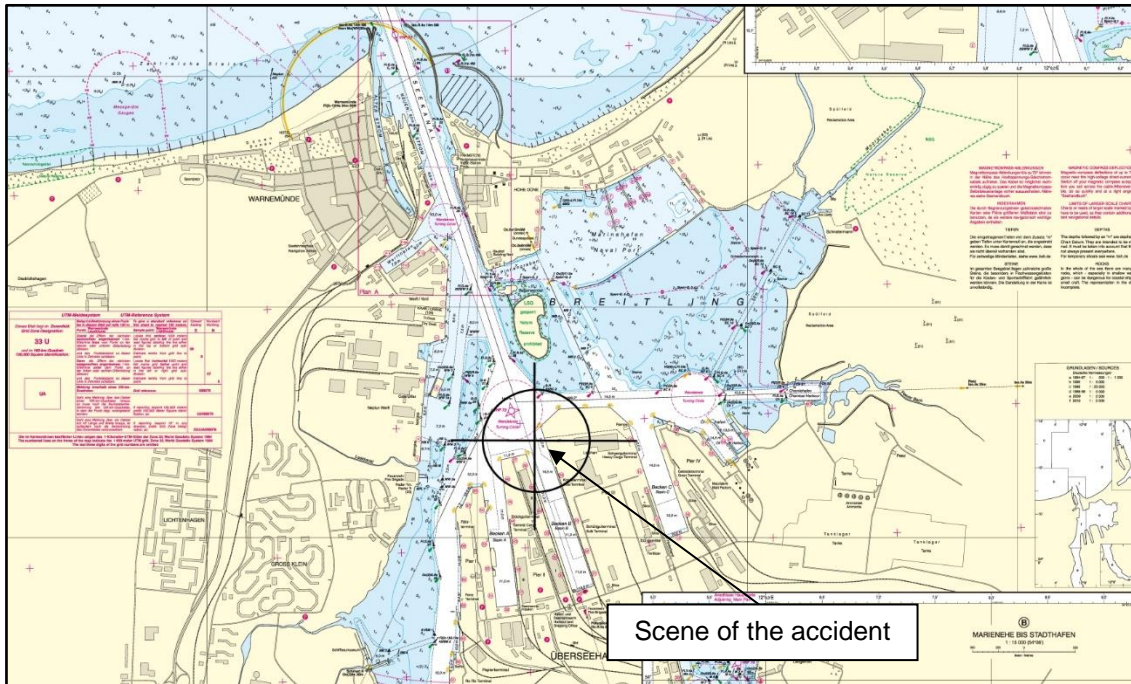

Figure 2: Navigational chart: Rostock overseas port, overview

Source: ROSTOCK PORT GmbH

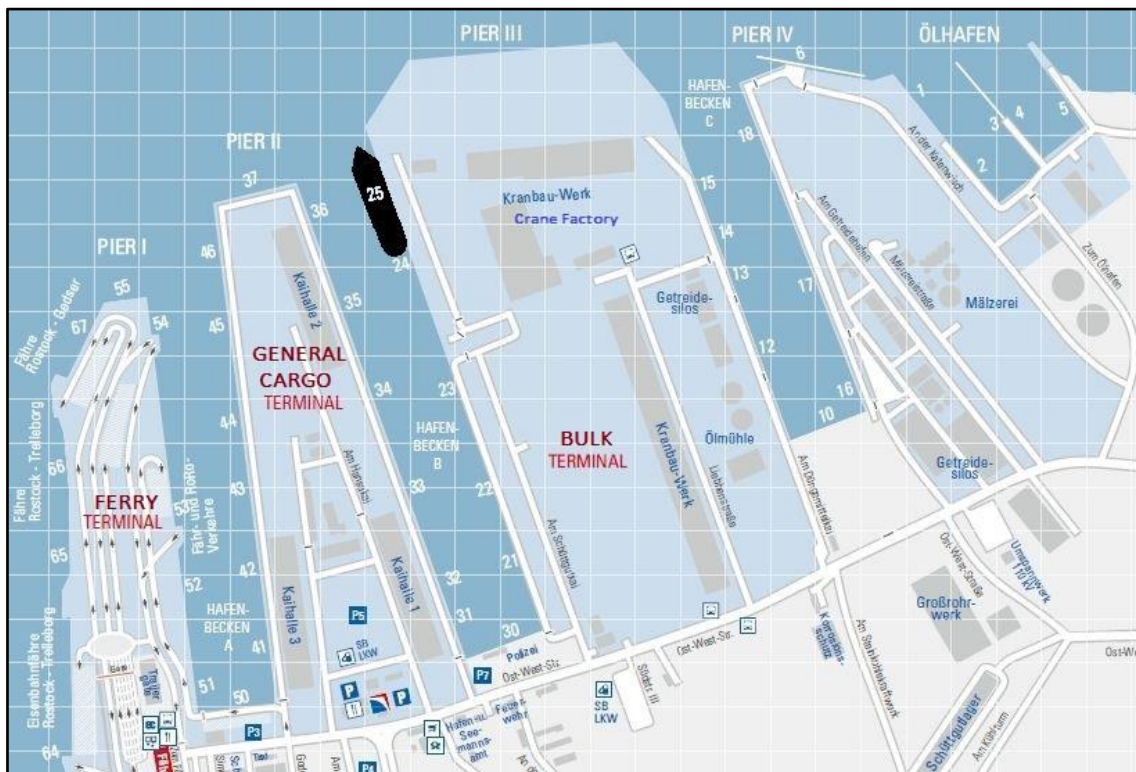

Figure 3: Detail: Rostock overseas port, berth 25

2.5 Shore authority involvement and emergency response

- Agencies involved:
- Waterway Police (WSP) Rostock
 - Rostock Harbour Master's Office
 - VTS³ Warnemünde
- Resources used:
- ARKONA (WSV⁴ multi-purpose vessel used for oil and chemical spill response),
 - tug for securing harbour basin,
 - floating crane HEBO LIFT 9 for salvage operations,
 - oil-spill response vessel HEBO CAT 8,
- Actions taken:
- spread of escaping operating fluids prevented by deployment of an oil barrier, among other measures,
 - samples of air and water taken by the ARKONA,
 - closure of the harbour basin,
 - divers tasked with determining the exact position of the cranes and later dismantling the crane jibs,
 - eventually complete salvage,
 - ship remained in Rostock until completion of necessary repairs.

³ Vessel traffic service.

⁴ German Federal Waterways and Shipping Administration.

3 Course of the accident and investigation

3.1 Course of the accident

The account of the course of the accident is based on written and oral statements given by the people involved and on scene, as well as on reports provided by the VTS, the WSP, the salvage company and Liebherr-MCCtec Rostock GmbH.

3.1.1 Events prior to the accident

The first meeting between all parties responsible for loading the mobile cranes was held on Liebherr premises at 1400 on 27 January 2020. One representative of Liebherr and one representative of the chartering company commissioned by Liebherr (which in turn had commissioned Jumbo Shipping with transporting the cranes), the “port captain”⁵ acting on behalf of Jumbo, and a foreman from the stevedoring company responsible for attaching and removing the cranes to and from the hoist discussed the planned procedures as well as the method statement⁶ drawn up by Jumbo Shipping, and agreed on a joint approach.

Source: Liebherr-MCCtec Rostock GmbH



Figure 4: Liebherr LHM 550 ready for use
On the models loaded, the hoist cables and hooks were absent and the supporting pads at each corner were implemented twice.

⁵ For the role of the port captain, see chapter 3.4.1.3.

⁶ The method statement describes the transport of cargo over the entire course of a voyage, including loading and unloading. It contains stability information for transfer and transport, cargo securing methods, lifting arrangements, and possibly also tidal influences, forwarding information, monitoring options, etc.

The loading operations began with a so-called “toolbox meeting”⁷ at 0645 on 30 January. Representatives of the ship, crane manufacturer and stevedoring company attended this and all following toolbox meetings for the loading of the two LHM 550s, as well as at least one technician who would be in charge of driving the crane. There are not written records of these meetings.

Over the course of the morning, the hatch covers were prepared for the carriage of two cranes of the same type (Liebherr LHM 550s, see Figure 4), which were going to be transported on deck to Apapa (Lagos), Nigeria.

Steel plates on which most of each crane's running gear would later stand (see Figure 5) were put down for load distribution. The plates had been taken on board in the previous port of Antwerp.



Figure 5: Steel plates laid out on deck
(view towards the stern; photograph taken after the accident)

⁷ A toolbox meeting is an informal meeting that focuses on safety issues relating to a specific forthcoming task, such as hazards or safe work practises. It is usually brief and takes place just before a task or shift begins.

The loading operations for the first crane (hereafter referred to as "crane 1") took place in the afternoon and evening of 30 January. Both units of the ship's own cargo-handling gear were operated together ("tandem lift") to achieve this.

The loading operations could not be continued on the morning of 31 January due to strong gusts of wind. The deck was wet due to an almost continuous drizzle.

The next toolbox meeting was held at 1300, when the loading operations were resumed after an improvement in the weather. Following that, the second crane ("crane 2") was lifted on board the JUMBO VISION. As in the first loading operation, the ship's own cargo-handling gear was used in tandem operation (see Figure 6).



Figure 6: Crane 2 being tandem lifted

Crane 2 was put down amidships. Crane 1 was in the forward deck area approximately in its final stowage position, still unlash⁸ and leaning on its supporting pads. Its jib was set about 30° to the seaward side.

The two cranes stood parallel to the ship's longitudinal direction. A transverse inclination of the ship (i.e. heeling) therefore also meant a transverse inclination of the cranes.

Crane 2 still had to be moved on deck before reaching its final stowage position. This was for the following reasons:

- Tandem operation only allows for a limited area in which to set down the load.

⁸ "Lashing" refers to the seaworthy securing of cargo by means of chains, straps, turnbuckles, etc.

- The stabilising pontoons (Figure 7), which were still in the water, needed to be hauled in. This was only possible with topped jibs on the LHM 550s, and when the cranes were arranged on deck in a specific way. Hauling the pontoons in would no longer have been possible afterwards (across the cranes in their final stowage position).
- The jibs of the two LHM 550s still had to be set down, as specified in the Liebherr transportation documents. Given their length of some 57 m each and the prevailing spatial conditions, this was no easy task (see Figure 8), and also involved minor movement of the cranes on deck. For this purpose, the ship's cargo-handling gear had to be slewed out of the way, and was secured for sea at the same time.

In both cranes, three of their five counterweights had not yet been removed, as this was only possible after the jibs were set down (i.e. had been moved for the last time). A shore-based crane was intended for this operation.

When the LHM 550 is being driven, its jib has to be topped up.



Source: JUMBO VISION

Figure 7: Stabilising pontoon in the water

At about 1700 and 1900 respectively the ship's two stabilising pontoons were drained and then moved from their deployment position on the seaward side to their stowage position at the stern using the ship's own cargo-handling gear.

Another toolbox meeting, this time concerning the positioning of the two cranes on deck, was held at 1800.

Moving the cranes on deck without stabilising pontoons in the water did not feature in the stability calculations and documentation prepared ashore by Jumbo Shipping. The movement of the weight of crane 2 on deck was therefore calculated in advance by the master, the chief mate and the port captain, using the loading computer on board, and found to be without complications. A heel of only 0.4° to port was reportedly expected.

If one of the loaded cranes had to be moved on deck, as was the case here, then this was only carried out by a crane operator exclusively responsible for this task (a Liebherr technician). Each crane had its own remote control, i.e. the operator stood next to the crane that was being moved. Communication with the port captain, who gave instructions to the crane operator, was in English.

The crew began preparatory work for securing the deck cargo at about 2000. At about 2045, the ship's cargo-handling gear was secured, which entailed moving crane 2 slightly aft.

Source: JUMBO VISION



Figure 8: View from the deck looking towards the stern after the two cranes were loaded

3.1.2 Events during the accident

At about 2045, the port captain, the Liebherr crane operator, all three deck officers, the bosun, the fitter⁹, four deckhands from the JUMBO VISION and several people who worked for the assigned stevedoring company were on deck. The master was on the bridge so as to be able to carry out any necessary ballasting operations. All the witnesses unanimously stated that the ship was upright and not listing at that time.

Crane 2 had just been moved a short distance aft and was now standing amidships with its support cylinders raised (see Figure 8 and Figure 9).

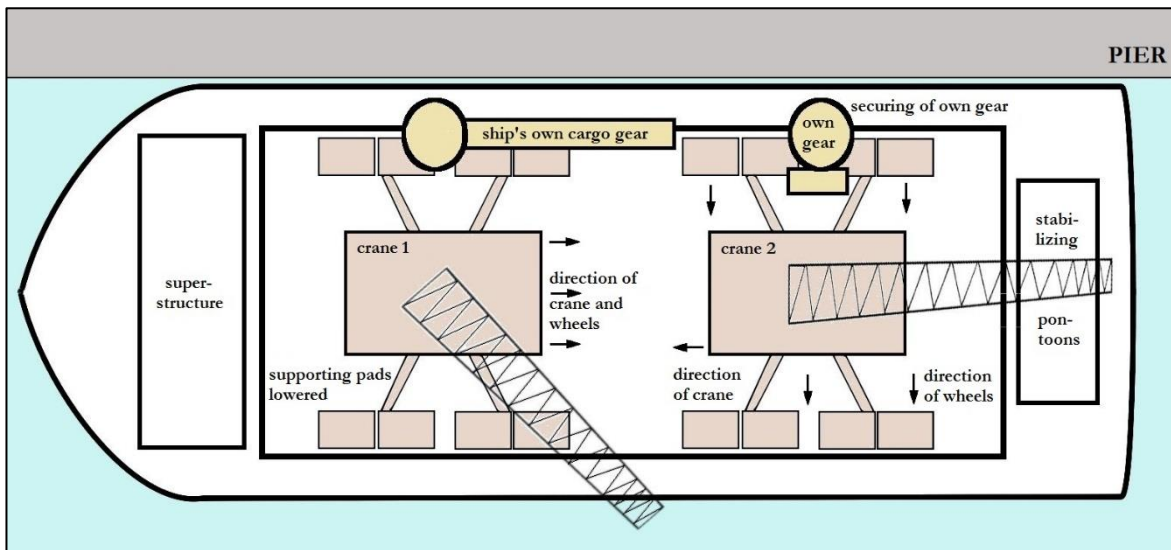

Figure 9: Schematic: Position of the cranes on deck just before the accident (length-to-width ratio distorted)

According to the planning, its final stowage position was to be further towards the seaward side, with the supporting pads outside the hatch cover on wooden blocks in the port side deck passageway.

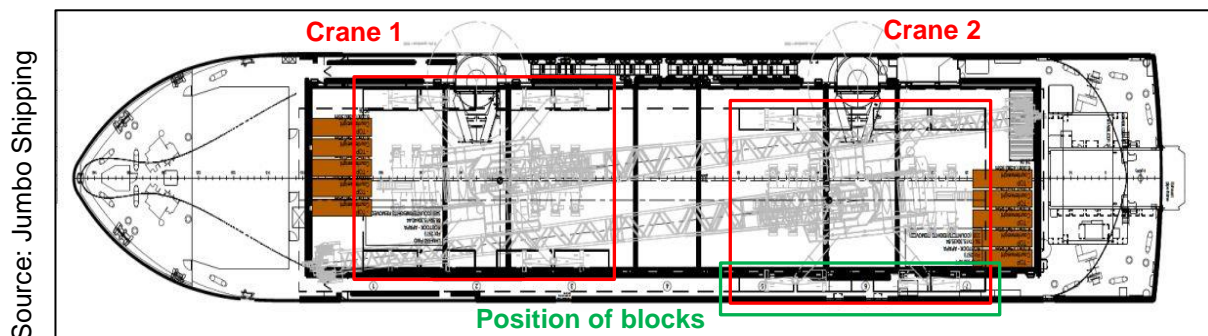

Figure 10: Stowage plan: Final stowage positions

The port captain issued instructions to move crane 2 transversely by about 20 cm to the seaward side, to allow crane 1's jib to be set down. Crane 2's wheelsets were swivelled to a transverse direction for this purpose (so-called "crab steer").

⁹ Qualified metal worker (here working as a welder).

At this point, crane 2 was pointing in the same direction as the ship, with its jib pointing aft.

The crane operator first moved the crane to the landward side by mistake, but stopped immediately and then moved it in the required direction.

Given that the wheelsets rotate through 360°, it is possible to confuse the direction of travel, because depending on the direction of rotation of the wheelsets when swivelling them, the forward and reverse directions on the remote control can mean left and right one time, and right and left the next.

After the crane had moved a few centimetres to the seaward side, the port captain issued instructions to stop because lashing equipment was in the way and had to be removed. The crane operator set the control lever on the remote control to neutral, but the crane seemingly did not respond and continued moving.

After that, he set the control lever first to slow, then to full speed in the opposite direction. However, once again the command had no effect on the crane's movement.

At about this point the master shouted over the radio to stop the crane, and that the ship had reached a list of five degrees. He started the anti-heeling system to "counter-ballast", i.e. pump water in the opposite direction of the list to serve as a counterweight.

However, the crane continued to move steadily towards the seaward side. At this point the witness statements differ. Some reported that the wheels kept rolling towards the seaward side, some stated that they were moving in the opposite direction, and others that they were literally spinning and shifting the steel plates underneath them.

As a last measure, the crane operator unsuccessfully tried to stop the crane by extending the support cylinders. When this also failed, he stopped giving drive signals via the remote control. Almost at the same time, crane 2's seaward wheelset row moved over the edge of the hatch cover with a sudden, jerking tilting motion. The wooden blocks in the port side passageway did not withstand the impact of the wheels and gave way, resulting in the crane tilting hard and falling into the 11 m deep harbour basin.

The heavy list that ensued caused the unsecured crane 1 on the front part of the hatch covers to slide and also fall into the water shortly afterwards. Its supporting pads broke off in the port side passageway because no wooden blocks had been put down there.

Since the anti-heeling system was slow (start-up time: 23 s¹⁰), no ballast water had been moved yet when the cranes fell overboard. The captain stopped the pumps immediately so as not to accelerate the expected violent righting motion of the ship.

3.2 Consequences of the accident

Immediately after the accident, the master ordered a headcount of the crew and other people on board, to ensure that all were present and unharmed. Nobody was absent,

¹⁰ This is in keeping with the usual, design-related range.

one person had suffered minor injuries to his ankle, and the crane operator was in a state of shock. Both were treated on scene by incoming emergency medical services.

A heavy rolling motion in the opposite direction did not occur after the JUMBO VISION had righted herself.

The harbour basin was immediately closed for maritime traffic. Due to the danger of floating debris and water pollution, VTS issued a warning to shipping traffic.

3.2.1 Environmental pollution

An oil barrier was brought out over a wide area around the scene of the accident because operating fluids were escaping from the cranes (lubricating oil, hydraulic oil from the pump drives, diesel fuel; see also Figure 11). A tug secured the harbour basin in which the accident had occurred. Using its propeller wake, it was able to prevent various items of floating debris from drifting into the adjacent federal waterway. A fuel tank that had drifted further away was later recovered by the fire brigade.

The ARKONA, a WSV multi-purpose vessel used for oil and chemical spill response, was kept on standby and took air and water samples. A second oil barrier was placed around the first because a small part of the oil slick was spreading further into the harbour. Due to the wind and light conditions, the spill could not be tackled in the wider harbour area that evening, and had "weathered out" by the following day. The oil slick within the oil barriers remained stable throughout.

3.2.2 Damage to the ship

The JUMBO VISION had to remain in Rostock until 0900 on 20 February 2020, but shifted one ship's length to berth 24 so as not to obstruct the necessary preparatory works for salvaging the cranes.

On 3 February, divers from the contracted diving services and salvage company found that the ship had sustained no structural damage to the underwater hull, only a few small dents, scratches and paint abrasions.



Figure 11: Damage to deck passageway, oil slick
(crane 1 visible under water)

Various repairs were carried out on the JUMBO VISION's damaged port side (see Figure 12 and Figure 13). For this, the ship was rotated and made fast with the damaged side alongside the pier. Class was confirmed by a Lloyd's Register surveyor, and the vessel was allowed to proceed only after the severely buckled and partly missing railing, the broken and buckled sounding pipes, overflows and vent heads, the damage to the main deck (dents and penetrations) and the lifting gear from the gangway, which had gone overboard, had been repaired.

Source: JUMBO VISION



Figure 12: Damage to port-side deck passageway caused by crane 1 (e.g. broken off supporting pad)



Figure 13: Damage to port-side deck passageway caused by crane 2 (sounding pipes, vent heads, overflows, wooden blocks, missing railing)

3.2.3 Salvage of the cranes

With the aid of divers and various geotechnical survey technologies such as side-scan sonar and multi-beam echo sounder¹¹, a three-dimensional image of the harbour basin bottom was created (see Figure 14) and the exact position of the cranes determined.

On 1 February, a first dive was carried out to the submerged cranes to determine the scale of the damage and possible necessary traffic restrictions. On 4 February, divers began pumping the operating fluids out of the cranes and sealing the oil leaks. They also removed large parts of the oil slick inside the oil barrier. On 8 February, the barrier was reduced to the area directly above the accident site, and a corridor was opened for passing traffic into the harbour basin.

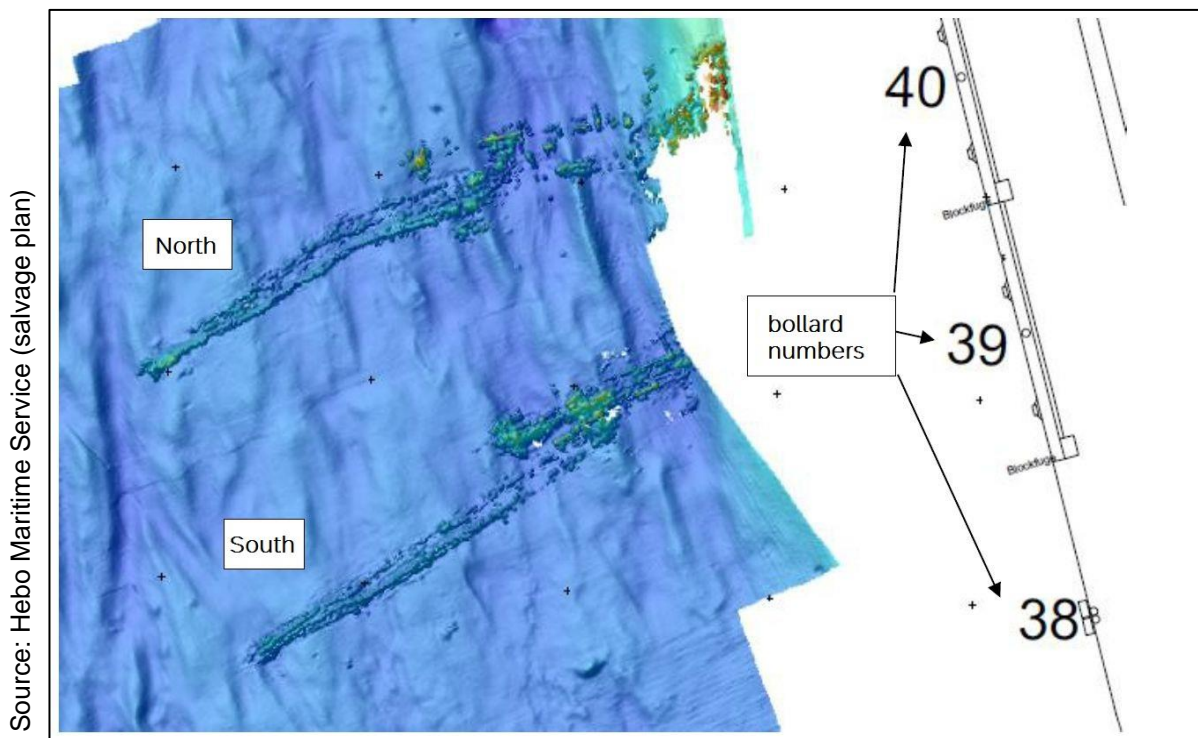

Figure 14: Three-dimensional image of the surveyed harbour basin bottom with damaged cranes

¹¹ Sonar and echo sounder technologies generate sound waves whose echo travel times are used to calculate the distance to reflecting objects and surfaces below the ship. Side-scan sonar and multi-beam echo sounder fan out and focus their transmitted signals differently, each operating within its own frequency range. Combining different surveyed strips of seabed (or in this case harbour basin bottom) enables the creation of a three-dimensional image of the terrain.

Source: Liebherr-MCCtec Rostock GmbH



Figure 15: The HEBO LIFT salvaging one of the LHM 550s

Between 2 and 5 March 2020, both jibs were disassembled under water, dismantled into two parts and salvaged separately, first the jib foot¹², then the jib head¹³. Immediately after the accident, a floating crane with a lifting capacity of 800 t was requested from Rotterdam (the HEBO LIFT from the Dutch Hebo Maritime Service), which arrived at the end of February and lifted the two cranes (see Figure 15) over the course of several days (6-10 March).

After a final inspection by divers, the oil barriers were removed on 10 March and the basin fully reopened to maritime traffic. Remaining small parts of debris were located by magnetometer¹⁴ on 17 March and salvaged between 24 and 31 March.

3.3 Subsequent events

During the following voyage (in the first week of April of the same year), two more Liebherr cranes – similar models to those scheduled for shipment on 31 January – were loaded onto the JUMBO VISION in Santos, Brazil, and transported to the customer in Apapa. Loading operations and voyage passed without complications.

¹² The jib foot is the part of the jib that attaches to the crane tower.

¹³ The jib head is the part of the jib with the “tip”.

¹⁴ Here, the magnetometer was used for locating ferromagnetic objects, i.e. for identifying steel debris on the harbour basin bottom.

3.4 Investigation

In the course of the investigation, the BSU was confronted with a large number of possible accident causes. These shall be presented below in the order in which they were worked through.

3.4.1 Basic findings

3.4.1.1 Heavy-lift vessel JUMBO VISION

The JUMBO VISION is a heavy-lift vessel built in 2000. She sails under the flag of the Netherlands and is operated by the Dutch Jumbo Shipping Co. SA.

Due to her two on-board cranes (each with a SWL¹⁵ of 400 t), the JUMBO VISION can operate independently of shore-based cargo-handling equipment and is therefore flexibly deployed for the international transport of heavy-lift and project cargo.

At the time of the accident, the ship's master, chief engineer, chief mate and second officer were from the Netherlands. The remainder of the crew were from Russia, Cape Verde, Ukraine and the Philippines. Communication language on board was English.



Figure 16: The JUMBO VISION on the day of the inspection by the BSU

3.4.1.2 Liebherr LHM 550

The LHM 550 is a self-propelled mobile harbour crane produced by Liebherr. It is designed for handling general and bulk cargo, containers and heavy loads of every kind. Its outreach is 54 m, and it can lift heavy loads up to 154 t. Depending on the version, it has a height of up to 40.3 m and a dead weight of up to 420 t.

¹⁵ SWL: Safe working load.

The LHM 550 consists of a rotating superstructure mounted on an undercarriage. The crane is operated from the control position inside the crane cab. In addition, operation using a remote control, worn on a belt in front of the body, is also possible (hence "self-propelled"). This was the case on the day of the accident.

By means of internal coding on both sides, each remote control is uniquely linked to a particular, single crane. The so-called "master switch signal" is generated via the control lever on the remote control. This operating signal is used to drive the crane's running gear as a whole, as otherwise the individual wheelsets would have to be selected separately.

The LHM 550 is hydraulically driven. A diesel unit drives several hydraulic pumps via a transfer box, which in turn supply the hydraulic motors (variable displacement pumps, hydraulically connected in parallel) with the required oil volume flow.

The crane's wheelsets are divided into three groups, ensuring that the load is distributed as evenly as possible across the undercarriage structure. Six of the 20 individual wheelsets (with four wheels each) on the running gear are driven by a motor (marked red; position of the hydraulic motors marked yellow; see Figure 17). All wheelsets can be rotated through 360°.

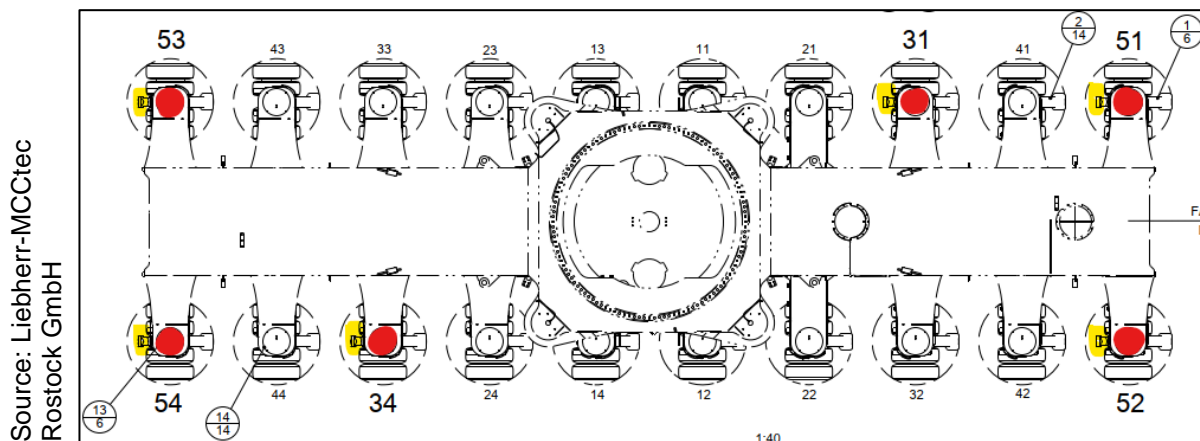

Figure 17: LHM 550 running gear

The crane's continuously variable speed is controlled via the oil volume flow provided at the motors. To prevent the hydraulics from having to hold the crane when it is at a standstill, each driven wheelset also has a spring-operated multi-disc brake, which acts as a holding brake and must be actively hydraulically actuated for it to open. This means that it closes automatically if the hydraulic actuation fails for any reason (e.g. failure of the diesel unit or pumps, emergency stop, or by default one second after the crane has come to a standstill; so-called "normally closed principle"). Since the crane is decelerated hydraulically, the multi-disc brake is a pure holding brake, and therefore it is subject to virtually no wear at all. If need be, the brakes are strong enough to stop the crane when it is moving. However, this is not necessary during normal operation.

The running gear on this version of the LHM 550 is approved for moving on surfaces with a longitudinal inclination of up to 5% (2.86°), or to brake hydraulically and remain at a standstill on such surfaces. Due to the reduced dead weight on the day of the

accident (only three instead of five counterweights), this figure increased mathematically to 6% (3.43°).

However, the crane's centre of gravity will naturally shift if the running gear moves across a surface inclined in a transverse direction to its undercarriage. This will result in one of the three driven wheelset groups being relieved, and another increasingly taking more weight and having to provide the drive power alone. Accordingly, the crane is only allowed to be moved at a transverse inclination of no more than 2% (1.15°). This figure presumably also changed on the day of the accident due to the missing counterweights, but to a much lesser extent, because the relief of individual wheelsets plays a much greater role here. Liebherr was not able to determine the precise transverse inclination that the crane would have been able to overcome on that day.

The maximum speed of the LHM 550 is 5 km/h for longitudinal movement and reduces to one third of the original speed, i.e. 1.67 km/h, for transverse movement. This is to limit the additional load on the wheelset groups caused by acceleration when starting or braking in a transverse direction.

As soon as the crane's holding brakes open (are hydraulically activated), a loud and regular acoustic signal sounds to warn people in the vicinity that the crane is moving. It stops one second after the crane has come to a standstill, i.e. when the brake is fully engaged again. If the master switch signal changes without the crane coming to a standstill for at least one full second because of a corresponding movement of the control lever (e.g. directly from forward to astern), then the acoustic signal continues uninterrupted.

As long as the diesel unit runs, the crane's jib and undercarriage are fully illuminated. When the unit is switched off, the lighting stays on for a few minutes to allow the operator to safely leave the operating area, then it goes off automatically.

The LHM 550 has four hydraulically retractable support cylinders, one at each corner of the running gear, for maximum stability during loading and unloading operations. Each cylinder either has a single supporting pad (see Figure 4) or – as was the case here – a double version (see Figure 18 and also Figure 6).

One of the two cranes (crane 2, which subsequently went overboard first) had a tower superstructure that was 4.8 m higher and made it about 12 t heavier than the other one.

Source: Karpack GmbH



Figure 18: Crane 2 with double supporting pad
(photograph taken after loading)

The LHM 550's control signals are recorded internally and stored on a data chip. The crane also has an inclination sensor that enables its tower to be positioned vertically, regardless of the surface inclination. This inclination sensor's values are also stored on the chip.

The customer ordered the two cranes that were involved in the accident in the standard version. The only exception were the double supporting pads, which reduce the ground pressure by increasing the contact area. All safety features (emergency stop, dead man function, user identification, unique radio coupling, immediate shutdown, e.g. in the event of improbable control commands, dropping the remote control, or if the switch-on sequence takes too long) are part of the LHM 550's standard equipment, however, and so is the internal data recording.

During loading operations, or when attaching and removing cranes from the hoist, their control systems are routinely manipulated, i.e. safety limitations are temporarily deactivated. This may be necessary, for example, when briefly retracting the supporting pads in order to pass slings under them, although the crane would normally block this if the superstructure is not parallel to the undercarriage. A similar procedure may be necessary for the jibs, which have to be kept at a certain height during the lifting process, i.e. moved if necessary, although the crane is of course not standing safely at that particular moment. These safety limitations are immediately reactivated

after the vessel is set down on deck. According to the data records, this was the case on the day of the accident.

3.4.1.3 Personnel involved in the accident

The crane operator, the port captain and the master were directly involved in the accident.

The German crane operator has worked as a mechatronics engineer and overseas service technician for Liebherr. He operates the LHM 550 frequently and thus has a lot of experience with the handling of this crane type and other models. Moreover, he is familiar with its technical characteristics. He was under the operational authority of the port captain for the duration of the loading and securing operations on 31 January. At the time of the accident, he was on deck between the two cranes that had been loaded onto the hatch covers.

The Argentine port captain supervised the loading and lashing operations on deck. He received his instructions from Jumbo Shipping, and locally from the JUMBO VISION's master. He has been working for Jumbo Shipping in this capacity for more than 20 years. For ten years prior to that, he served as a master on various types of ship, including heavy-lift vessels. Before the accident, he had already managed five similar harbour crane loading operations, three of them in Rostock at Liebherr. At the time of the accident, he was on deck between the two cranes on the hatch covers.

The JUMBO VISION's Dutch master has served as master since 1991, and on Jumbo ships since 2009. Before the accident he, too, had already made several voyages as master with mobile harbour cranes as deck cargo. In accordance with the "four-eyes principle", he and the chief mate directed the lifting operations from the pier when the two cranes were being loaded on 30 and 31 January. Later, at the time of the accident, he was on the bridge. He maintained voice contact via UHF with the port captain, bosun and chief mate. To a certain extent he also had a visual overview of the events, thanks to a monitor that showed the deck area aft of the bridge.

The following people were also on deck but not directly involved in the accident: two ABs¹⁶, the bosun and the chief mate, who were occupied with securing the ship's own cargo-handling gear in the aft section; two other ABs, who were between the cranes on deck preparing lashing equipment for the seaworthy securing of the mobile harbour cranes on deck; the second officer, the third officer, and the fitter, who were also making preparations for securing the deck cargo; as well as four employees and a foreman from the stevedoring company, who were waiting in the aft deck area.

3.4.1.4 Survey of the scene of the accident

A law firm acting on behalf of the shipping company notified the BSU of the incident on the morning of 1 February 2020 via the on-call number. BSU investigators visited the ship at her berth in Rostock on the same day. The cranes that had fallen over board were clearly visible underwater (see Figure 11) and the oil barrier had already been deployed.

¹⁶ AB: Able-bodied seafarer.

Steel plates were visible on deck. They were in the same positions as they had been immediately after the accident. Four plates stood out in particular: They were no longer amidships but had been pushed to the seaward edge (see Figure 19 and Figure 5). All other plates were still in their original positions.

Source: Battermann & Tillery GmbH



Figure 19: Position of the steel plates on deck after the accident
(view to aft)

A relatively large amount of sand was also found spread across the deck, a sample of which was taken.

In addition to two lawyers from the acting law firm, two officers from WSP Rostock and two representatives of the P&I insurance company were also on board. The crew, in particular the master, was questioned about the course of the accident. The port captain and the crane operator were not available for questioning. The law firm later provided written accounts of the accident from all the people present. The investigators secured the VDR data.

Another visit on board by two BSU investigators took place on 13 February 2020. In addition to photographically recording the general condition of the hatch covers and damage to the gangway, vent heads, overflows, sounding pipes, railing etc., they also documented and measured tyre marks and other signs of abrasion on deck.

In the afternoon of the same day, a meeting of all parties involved in investigating the accident was held on the premises of Liebherr in Rostock (the general management of Liebherr-MCCtec Rostock GmbH and its legal counsel, a maritime expert, two BSU

investigators and two representatives of WSP Rostock). Liebherr presented the presumed course of the accident based on the findings available at that time.

The statements of the people involved agreed that crane 2 had not seemed to follow the control signals of its remote control. This led to the investigators' first working hypothesis regarding the course of the accident, and they subsequently secured the remote control. The chief mate of the JUMBO VISION had taken charge of it after the accident. Its emergency stop had not been activated, and unlike the remote control of crane 1, it had not fallen overboard because it had been in use when the accident happened.

3.4.2 Hypothesis 1: Unreliable radio link

The first of several accident hypotheses that the BSU investigated was therefore the following: How reliable had the radio link been through which the remote control and the crane had "communicated" with one another?

To answer this question, the operating instructions for the remote control were requested from the manufacturer, HBC-radiomatic.

3.4.2.1 Radio signal switchover

According to the instruction manual, it is not possible for the radio signal of a remote control to skip or change over, and suddenly establish a connection with another crane. As already discussed, each remote control is uniquely paired with a single crane via internal coding, precisely to prevent this from happening. Moreover, each radio link between transmitter and receiver requires activation via an infrared link and a unique switching operation.

3.4.2.2 Loss of radio signal

A complete loss of the radio signal is also not conceivable as the cause of this accident. Firstly, the radio system responds to a loss of radio link with the illumination of a red LED and a requirement to put the control lever into its neutral position and press the start button again, before any further operation is possible. There was no time for this in the course of the accident: The last movement of crane 2 until it fell into the water did not even last one full minute. Secondly, the remote control's display continuously shows the field strength of the radio signal, so that the operator can move closer to the crane if necessary. According to the operator's statement, however, he did not have to do this at any time.

The manual does not give any specific numerical data for the radio range. But the significantly lower infrared range (for activation of the radio link) was specified as 20 m, and not even this was exceeded on the evening of the accident because the operator was standing right next to the crane.

3.4.3 Hypothesis 2: Malfunction

Had the remote control been working properly at all at the time of the accident?

On 5 February 2020, a BSU investigator had the opportunity to visit Liebherr's company premises in Rostock and test the remote control that had been secured. The aim was to check for possible limitations or malfunctions.

Under the guidance of a Liebherr technician and after pairing the remote control with an identical LHM 550 via radio link, all standard functions were first run through several times, to which the crane responded without any problems. The operator then tried out various atypical operating commands and actions, such as several simultaneous commands, contradictory control lever positions, as well as not holding the remote control horizontally, shaking it or dropping it (in each case after explicit permission had been given). The result was the same every time: If the crane failed to "understand" a command, or if safe operation was jeopardised, it would stop immediately.

The technician also confirmed that he did not believe it possible for a radio signal to switch over or be lost, especially if the operator was standing right next to the crane.

Both an unreliable radio signal and a malfunctioning of the remote control could thus be ruled out as the cause of the accident.

3.4.4 Hypothesis 3: Operating error

Taking into account the witness testimonies, it now seemed reasonable to assume that the next possible cause of the accident had been an operating error, in terms of the commands given via the remote control.

3.4.4.1 Data chips

After the cranes had been salvaged, the data chips from both cranes could be recovered and – thanks to their protected installation – read out and analysed even after several weeks under water. Liebherr-MCCtec Rostock GmbH provided the BSU with these analyses (some graphical), together with detailed explanations of their interpretation.

Figure 20 shows the signal values of crane 2 (the one that seemingly did not respond) in the minute leading up to the accident. The values help reconstruct exactly what happened at the relevant time stamps.

20:48:21: *The crane is started up.*

- *There is a signal for movement in one direction (light grey).*
- *The holding brakes are actuated, i.e. hydraulically released (light green).*
- *The master switch signal (light blue) increases in a positive direction.*

20:48:23: *The crane is reversed in the other direction.*

- *There is a signal for movement in the other direction (red) (second running gear pump).*
- *The signal for movement in the original direction (light grey) drops to zero.*
- *The holding brakes remain actuated (light green), i.e. released.*
- *The master switch signal (light blue) drops. There is a zero crossing and a polarity change.*

→ *Confirmation that movement was initially in the wrong direction (landward), before the error was noticed and the crane reversed in the correct direction (seaward).*

20:48:36: *All drive commands go to zero.*

- *The signal for movement to the seaward side (red) goes to zero.*
- *The actuation signal for the holding brakes (light green) goes to zero.*
- *The master switch signal (light blue) goes to zero.*
- *The value of the lateral tilt angle (dark green) increases steadily.*

→ *Confirmation that an attempt was made to stop the crane by releasing the control lever (so that an obstacle could be cleared out of the way).*

20:48:38: *The crane's drive is reversed once again.*

- *There is a signal for movement in the other direction, to the landward side (light grey).*
- *The holding brakes are actuated and thus released once more (light green).*
- *The master switch signal (light blue) increases in a positive direction.*

→ *Confirmation of a drive command in the opposite direction (because the stop command had not worked).*

20:48:57: *The support cylinders are extended.*

- *The support cylinders are actuated (yellow and magenta).*
- *The angle of inclination (dark green) has reached about 4-5°.*

→ *Confirmation that this attempt to bring the crane to a standstill also took place.*

20:48:58: *All movement command signals stop.*

- *Except for the actuation of the support cylinders (yellow and magenta), which would have had to be actively retracted, all steering and movement signals go to zero.*

→ *Confirmation that no movement commands were made immediately before the accident, and that the control lever was released, i.e. set to zero.*

20:49:01: *The signal of the angle of inclination (dark green) is briefly subject to a strong swing in the opposite direction¹⁷ before quickly dropping again and cutting off at -8° (overmodulation)¹⁸.*

→ *Confirmation that the crane fell off of the hatch cover with a jerking tilting motion, and then overboard.*

¹⁷ The jerking tilting motion over the edge of the hatch cover causes such strong acceleration values that the value measured by the inclination sensor (gravitational acceleration) is briefly distorted (superimposition by external acceleration / inertia). Accordingly, the time of this spike is the time of the tilting motion, despite the wrong polarity.

¹⁸ If measured input signal values exceed the calibrated reception range of a signal-processing unit, then overmodulation occurs, i.e. a "cut off" of the shown input signal at the calibrated maximum or minimum value. In this case this means that, starting from the time the graph is exactly horizontal, the value of the angle of inclination is greater than the maximum +/- 8° that can be processed.

Source: Liebherr-MCCtec Rostock GmbH

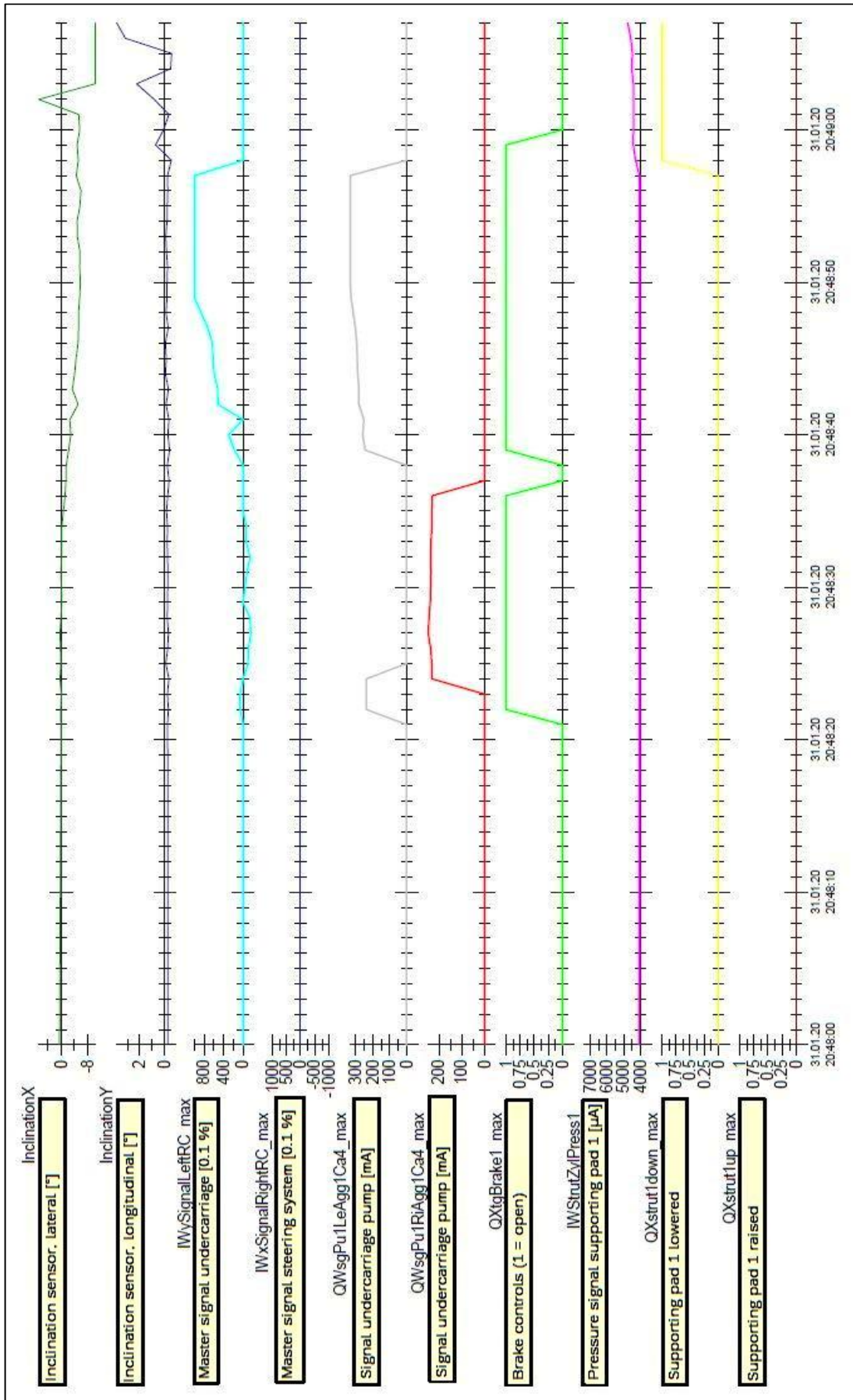

Figure 20: Summary: positioning and sensor signals of crane 2 in the minute leading up to the accident

Figure 21 compares only the signals of the two running gear pumps and the master switch signal during the same period of time.

The control system generates a signal every 25 milliseconds, but the data chip only records once every 1000 milliseconds, for reasons of data reduction. Therefore, of the 40 control signals per second, only the maximum value (red curve) and the minimum value (green curve) are recorded for that second. All of the recorded values therefore lie between the red and green curves.

For this reason, the apparent zero value of the light blue master switch signal in Figure 20 at 20:48:29 was not considered to be one, because Figure 21 shows that this value does not go all the way back to zero at all. On the other hand, the zero value shortly afterwards at 20:48:36 is "real", as both curves go to zero in this case. Only here the control lever was truly in neutral position¹⁹.

The analysis of the data chips shows that the switching actions of the crane operator are consistent with the statement he later made. The course of the accident described by the witnesses can also be confirmed by this analysis. Accordingly, an operating error by the crane operator can also be ruled out as the cause of the accident. Additionally, these recordings show that the radio signal between remote control and crane was never lost, because all switching operations were recorded, right up until the time of the accident.

¹⁹ The horizontal sections of *these* curves are not caused by overmodulation, because no *input* signal (measured value) is too large, but rather the maximum value of an *output* signal (setpoint value) has been reached (maximum deflection of the control lever). So the value of the signal in the horizontal segment of the curve corresponds to its reading all the time (control lever is held in its end position). Unlike in overmodulation, this value is never greater.

Source: Liebherr-MCCtec Rostock GmbH

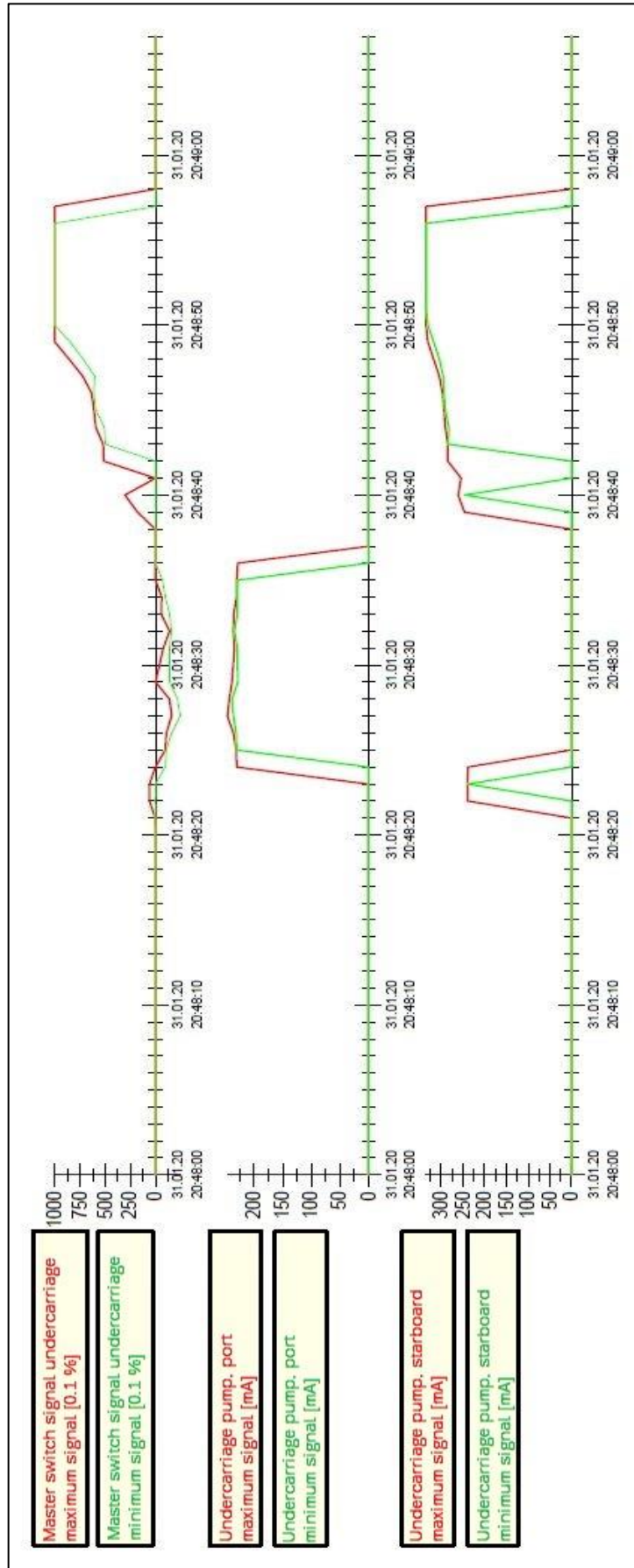

Figure 21: Detail: Crane 2 running gear actuation

3.4.5 Hypothesis 4: Adverse weather conditions

After excluding a faulty remote control and operating errors, the BSU went on to examine whether the meteorological conditions might have caused the accident.

3.4.5.1 Report by Germany's National Meteorological Service (DWD)

To gain a general overview, a weather report was requested from the DWD for the day of the accident.

A westerly wind of 5–6 Bft, with peaks in the morning of up to 8 Bft due to gusts and localised jet effects, prevailed in Rostock on 31 January 2020. Temperatures were about 5 °C, visibility was good, and there was a light drizzle.

At the time of the accident, witnesses unanimously stated that the hatch covers were wet due to an almost continuous drizzle. The wind had died down to about 5 Bft.

The report demonstrates that the weather conditions in the respective parts of the day were properly reflected in the decisions to carry out or interrupt the loading and cargo securing operations.

At the time of the accident, the wind was not nearly strong enough to push the crane into the water, especially not against the force of its hydraulic drive.

3.4.5.2 Expert report on the coefficient of friction

The next step was to investigate what influence reduced friction due to the wet deck surface might have had on the accident. To this end, the BSU commissioned an expert report on the prevailing coefficient of friction. Since it was considered possible that the crew had deliberately spread the sand found on deck to reduce friction, i.e. had feared a problem in this regard, the sand sample was also prepared for submission.

However, after inspecting the documents, the responsible expert reported back that, in his view, an expert report would not be useful. Although a coefficient of friction²⁰ of $\mu \approx 0.05$ could be surmised between the steel plates and wet steel hatch covers, i.e. virtually no frictional resistance, almost all the steel plates were still in their original position, so for the most part they had not been shifted sideways with the crane.

Furthermore, some of the crane wheels would have been standing directly on deck in any case. This would have resulted in a coefficient of friction of approximately $\mu \approx 0.5$ ("tyres on wet steel"), which would be equivalent to an angle of friction²¹ of 26.6°. Unanimous statements, however, indicate that this heeling value was not nearly reached at the time of the first stopping attempt. Accordingly, an expert report on the coefficient of friction was dispensed with.

During another BSU visit on board the JUMBO VISION, on 15 May 2020 in Hamburg, the master stated that the sand found on deck had not been spread by the crew, but was simply dirt that had come on board with the steel plates.

²⁰ All mentioned coefficients of friction μ relate to static friction.

²¹ Maximum angle at the onset of slipping, with a given material pairing (pair of surfaces). The coefficient of friction is the tangent of the angle of friction, i.e. the ratio of the angle's catheti.

Adverse weather conditions were thus also eliminated as the sole cause of the accident. The expert had confirmed a very low friction value between hatch cover and steel plates. The assumption that the crew had feared problems with friction and therefore proactively spread the sand was disproved.

3.4.6 Hypothesis 5: Pre-existing heel to seaward side

The next question was whether the surface on which it was moving was already so inclined that crane 2 could no longer overcome the incline or had started slipping. Had the ship already been heeling to the seaward side? Or did incorrect ballasting during the crane's movement lead to this?

3.4.6.1 Demonstration of a ballast operation

On 15 May 2020, the master demonstrated to BSU investigators the duration of a ballast operation on the JUMBO VISION. Her heel was changed from 0° to 2° (including the start-up phases of the respective pumps, etc.). His aim was to show that ballasting or counter-ballasting at the speed at which the accident had occurred would have been impossible. About 42 seconds passed from the moment crane 2 was set in motion to the presumed time at which it went overboard. The demonstrated ballast operation took almost two minutes. Also, all witnesses unanimously stated that the ship was upright at the beginning of the movement. A failed ballast operation during the crane's movement was therefore ruled out. (As per the relevant rules, the VDR neither records the ship's heel nor the filling level of ballast tanks.)

3.4.6.2 Inclination of crane vs. inclination of ship

The master also stressed that, in his opinion, the cranes' inclination sensors do not necessarily indicate the inclination of the surface on which it is standing, because the cranes could not be relied upon to align themselves vertically. As evidence, he provided the BSU with photographs of the loading operations for the replacement cranes that went from Santos to Apapa in April 2020 (see Figure 22 and Figure 23).

This initially called into question the validity of the cranes' inclination sensors as a measure of the inclination of the surface underneath it.

Source: JUMBO VISION



Figure 22: Loading of LHM 550 cranes on the following voyage (view of deck area)
 The tower of the ship's cargo-handling gear and that of the Liebherr crane are not parallel;
 the equally extended support cylinders have different distances from the deck

Source: JUMBO VISION



Figure 23: Loading of LHM 550 cranes on the following voyage (view of horizon)
 The insertion of rectangles shows that although the ship was not heeling
 (own cargo-handling gear, left, is at a right angle to the horizon), the loaded crane was still inclined
 (right; no right angle)

3.4.6.3 Surveillance cameras

The BSU had early access to two video recordings of the accident, both from surveillance cameras in the port of Rostock. One filmed the JUMBO VISION from aft (see Figure 24 ff.), one at an oblique angle from the side (Figure 27). Both recordings show the ship relatively far away (Figure 28). The extremely bright lights on the jib of crane 2 on deck apparently prevented the autofocus of the camera filming from aft from working properly: The image only comes into focus when crane 2 (including its lights) falls overboard – in the crucial moments before and during the accident, it is out of focus. The other camera shows the ship at such a distance that image quality is poor at all times.

Nevertheless, the videos clearly show both cranes falling into the harbour basin – most clearly crane 2 (which fell first) because it was in operation at the time and its jib was illuminated. However, the plunge of the unlit crane 1 shortly afterwards can also clearly be seen.

It is also evident that the JUMBO VISION was not heeling significantly before the accident (see Figure 24). This corresponds to the values of the inclination angle signal from the data chip analysis (see Figure 20). The same is true for the witnesses' statements.

Accordingly, the ship was not heeling on the seaward side at the time of the accident. On that day, the inclination sensor evidently correctly indicated the inclination of the surface on which the crane was moving. Possibly the orientation of the crane's tower is not automatically an indication of the inclination sensor's measurements.

Source: ROSTOCK PORT GmbH
(via WSP Rostock)

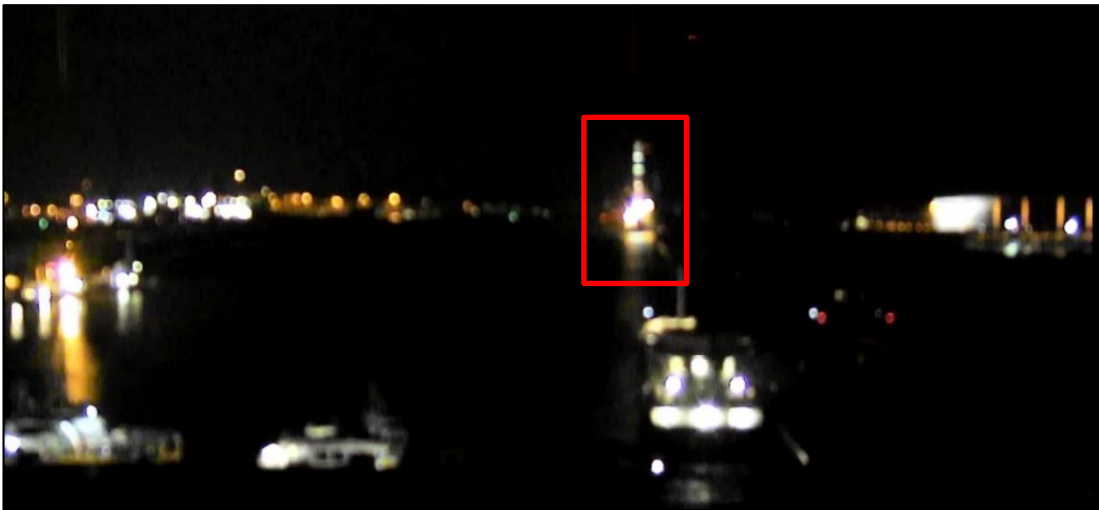

Figure 24: Screenshot: surveillance camera directly before accident

Source: ROSTOCK PORT GmbH
(via WSP Rostock)



Figure 25: Screenshot: surveillance camera showing crane 2 falling

Source: ROSTOCK PORT GmbH
(via WSP Rostock)



Figure 26: Screenshot: surveillance camera showing crane 1 plunging
(all: clipped image; view from aft)

Source: ROSTOCK PORT GmbH
 (via WSP Rostock)

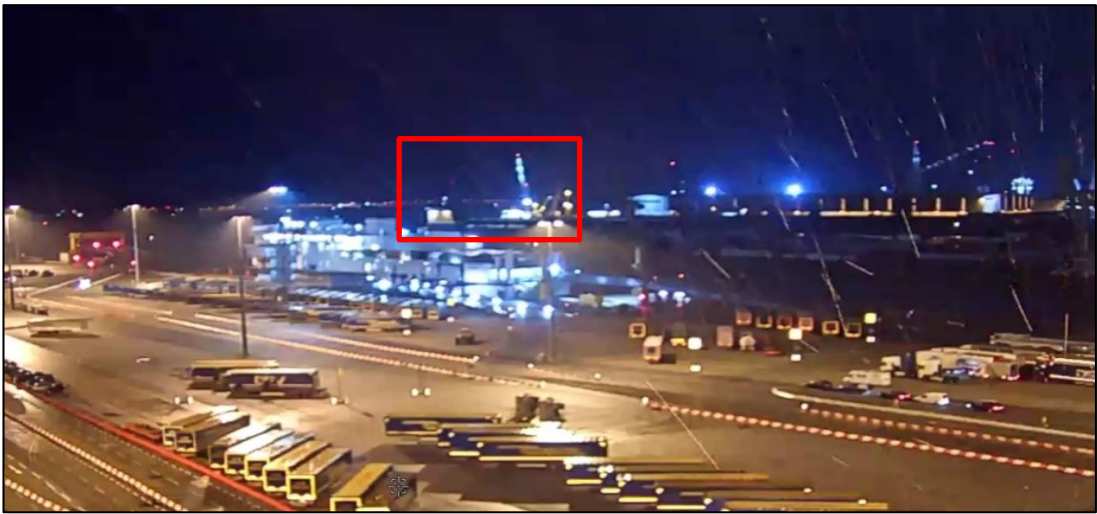

Figure 27: Screenshot: second surveillance camera before accident
 (view from the side)

Source: ROSTOCK PORT GmbH

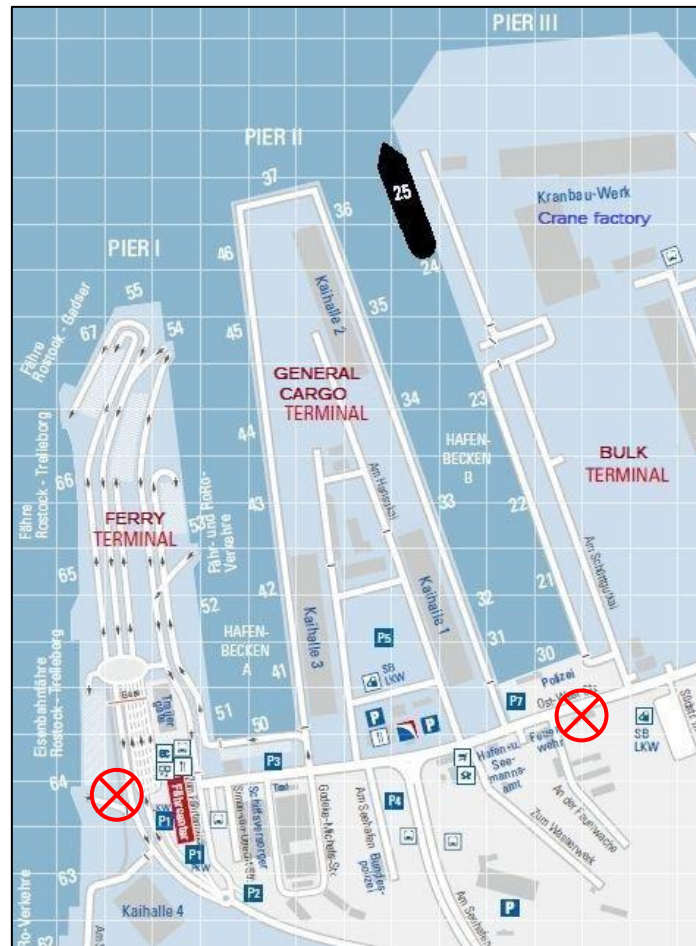



Figure 28: Surveillance camera positions 
 in relation to berth 25

3.4.7 Hypothesis 6: Collision with the ship's own cargo-handling gear

Shortly after the accident, an anonymous witness stated on the radio that he saw the JUMBO VISION's own cargo-handling gear collide with one of the cranes loaded on deck, and then allegedly push it into the harbour basin. This hypothesis was also disproved – as will be shown below.

3.4.7.1 Surveillance cameras

To investigate the statement, the film sequence showing the ship's own cargo-handling gear being slewed was examined in greater detail.



Figure 29: Screenshot: surveillance camera, shortly before slewing of ship's own cargo-handling gear (crane 1 still in operation)

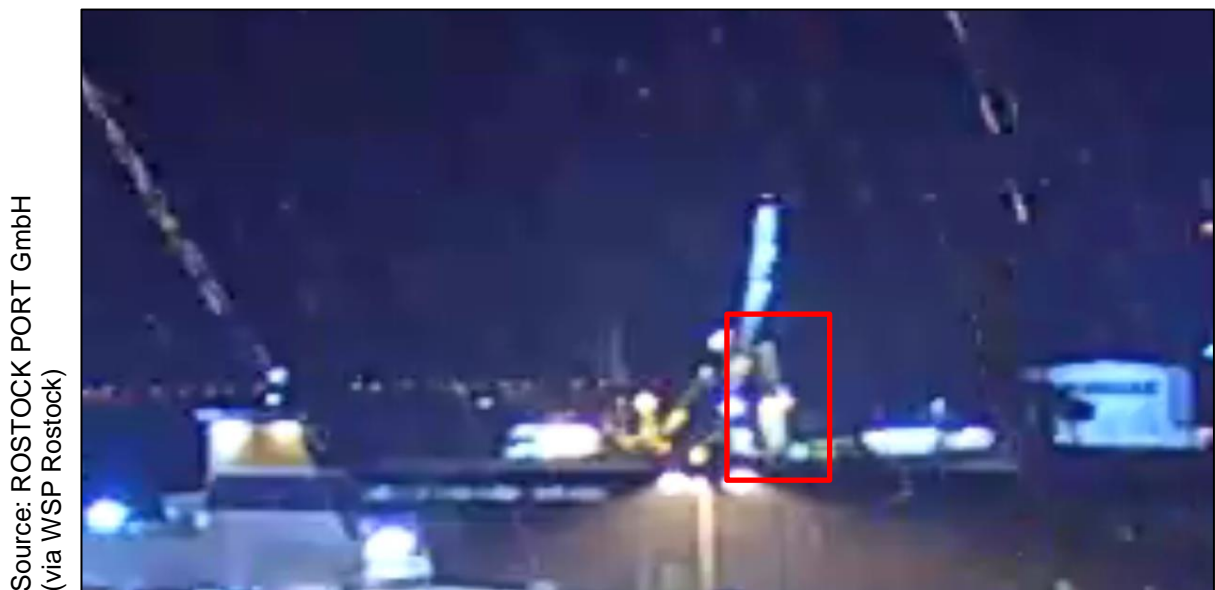

Figure 30: Screenshot: surveillance camera, after slewing of ship's own cargo-handling gear (crane 1 no longer in operation)

The camera filming from the side shows this slewing process about two and a half minutes before the accident (Figure 29 and Figure 30). The statements of the witnesses on board indicate that the ship's cargo-handling gear was to be secured parallel to the cargo securing operations (see also p. 18). The video filmed from aft clearly shows how the ship responded to this slewing process.

Based on the film footage and using a digital and graphical measurement technique (photogrammetry), Dr Manfred Wiggenhagen from the Institute of Photogrammetry and Geoinformation (IPI) at the Leibniz University Hannover determined the value of the angle of crane 2's jib against the horizon on behalf of the BSU²².

A maximum jib angle of 92.2° was determined when the slewing process took place (20:45:59), i.e. a clear heel to the landward side (see Figure 31). Crane 2's position sensor recorded a landward inclination of 2.1° at the same time²³.

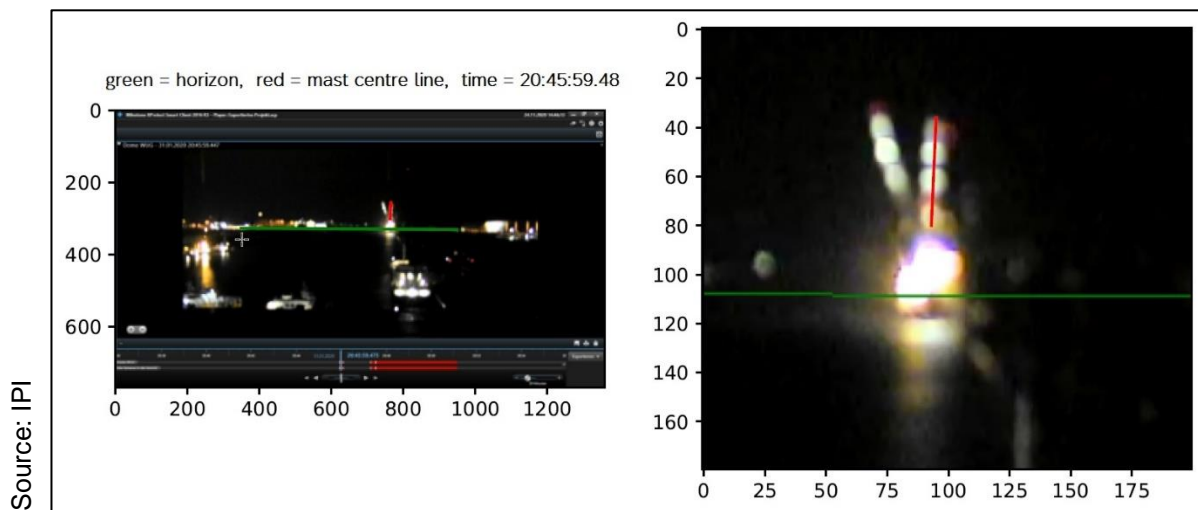

Figure 31: Photogrammetry:
 Heeling to landward side due to slewing of the ship's own cargo-handling gear
 (approximately two and a half minutes before t_0 ; reading 92.2°)

The slewing of the ship's own cargo-handling gear was therefore clearly visible. However, it had been completed and the ship had already righted itself fully, *before* crane 2 was set in motion, which was also clearly visible.

The IPI measurements additionally confirmed that there was no heel to the seaward side when the accident happened (see also chapter 3.4.6.3).

3.4.7.2 VDR microphones

The sound recordings of the JUMBO VISION's VDR also debunk any simultaneous movement of the cargo-handling gear and crane 2. The external microphones in the bridge wings recorded first the hydraulic pumps of the cargo-handling gear and then, after a distinct pause with no crane noises, the regularly repeating acoustic warning

²² Values < 90°: measured jib inclination to seaward side, values > 90°: to landward side.

²³ The raw data for this period of time (without graphic visualisation) was provided to the BSU.

signal of the moving crane 2. Similarly, no contact between the cargo-handling gear and the crane can be heard (a crashing sound or similar would be expected).

3.4.8 Hypothesis 7: Influence of stability and rolling behaviour

The hypothesis that stability issues might at least have contributed to the accident had been raised from the outset, along with all the other theories.

This assumption was further supported by the fact that, in terms of stability, the reaction of the JUMBO VISION to the simple slewing of her own cargo handling gear had been noticeably "tender" (i.e. her stability was comparatively low).

The BSU investigators turned to Prof. Dr.-Ing. Stefan Krüger from the Institute of Ship Design and Ship Safety at Hamburg University of Technology (TUHH) and requested an expert report²⁴. The questions put to him were those that continued to trouble the investigators:

- How is it possible that a crane that was being moved transversely could no longer be stopped, even though such operations had often been carried out with cranes of the same design loaded on deck?
- What options would have been available to prevent the accident?

The TUHH was provided with all documents and data that were also available to the BSU.

3.4.8.1 Surveillance cameras

To begin with, BSU and TUHH examined the JUMBO VISION's movements directly before the accident in greater detail.

As already explained in chapter 3.4.7.1, the movement of the ship's cargo-handling gear alone – a standard operation – caused a change in heel so great that, according to the manufacturer's specifications, the LHM 550 may no longer be moved at a lateral inclination (more than $2\% \triangleq 1.15^\circ$, or possibly slightly more due to the lack of counterweights). This remains true even after taking into account probable measurement inaccuracies, or assuming that a trend was recorded rather than an absolute value.

The photogrammetric measurements were therefore extended to the minute before the accident took place. First of all, key events in the course of the accident confirmed that the time stamps of cameras and data chip recordings were synchronous. The IPI was then asked to determine the inclination of the jib at further specified times (see Figure 32).

²⁴ Hereafter referred to as "stability report".

Source: PI	image : t0.jpg, angle : 88.31 °, time : 20:48:21
	image : t1.jpg, angle : 86.82 °, time : 20:48:36
	image : t2.jpg, angle : 85.72 °, time : 20:48:41
	image : t3.jpg, angle : 84.30 °, time : 20:48:51
	image : t4.jpg, angle : 84.42 °, time : 20:48:56

Figure 32: Photogrammetrically determined heeling angles

Due to the quality of the underlying images, and because the jib was not exactly vertical, the angles determined this way were not considered to be absolute heeling angles of the JUMBO VISION, but rather relative or tendency values. The effect of the crane's movement relative to the ship (i.e. its travel) was also neglected.

t_0 was the time at which crane 2 was set in motion. It is assumed that the ship was upright at this point. This was unanimously stated by all the witnesses. Moreover, in addition to the above explanations on heeling, this assumption corresponds to the data chip values of the inclination sensor of crane 2 (see Figure 20).

The JUMBO VISION had apparently already reached a heel of about 1.5° to the seaward side at t_1 (15 s after setting off), when the involved parties still believed that there was no problem²⁵.

Two seconds later, the crane operator tried to stop the crane by discontinuing the master switch signal (i.e. releasing the control lever). At t_2 (20 s after setting off; heel about 2.5°), this had already failed and an attempt was made to reverse, but without the desired result.

Times t_3 (30 s after setting off) and t_4 (35 s after setting off; heel about 4° in both cases) are within the period in which the crane continued to move uncontrollably to the seaward side. At t_4 , an unsuccessful attempt was made to extend the support cylinders.

Immediately afterwards, crane 2's seaward wheelset moved off the hatch cover with a jerk, and about five seconds later, a good 40 seconds after it had started to move, it fell into the harbour basin.

The increasing heel between t_0 (setting off) and t_4 (extending the support cylinders) is clearly visible in the video recordings (see Figure 33).

²⁵ The heeling values given here are relative to the angle at t_0 .

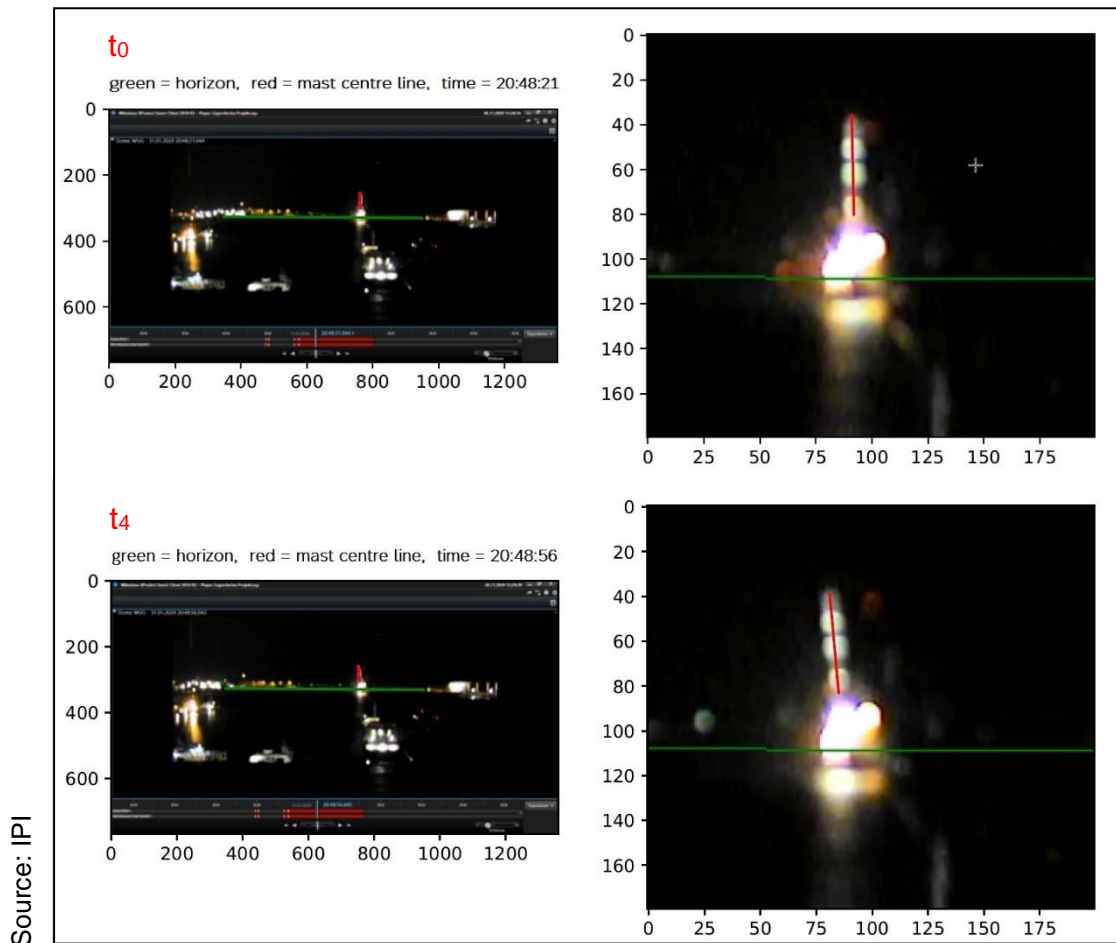

Figure 33: Photogrammetry: t_0 and t_4 comparison
 ($t_0 \triangleq 0^\circ$ heel, reading 88.31° ; $t_4 \triangleq 4^\circ$ seaward heel, reading 84.42°)

The initial evaluations for the stability report began here. Krüger reproduced the calculated angles by placing a graphic "pendulum" on his screen – simple strips of adhesive tape that made it possible to clearly observe and measure the increasing incline of the jib. His thus calculated angular values are close to those of the IPI (see Figure 34, light blue curve).

Figure 34 compares the angles determined by the IPI and the TUHH, as well as those of crane 2's inclination sensor over a period of almost two minutes. Over the course of the last movement of the crane up to the accident, an *increasing* heel is clearly visible – in contrast to the originally assumed heel that *already* existed at t_0 (which was refuted). The observed heeling motion does not seem to be linear, as one might expect for a crane travelling sideways at a constant speed, but rather resembles an oscillation.

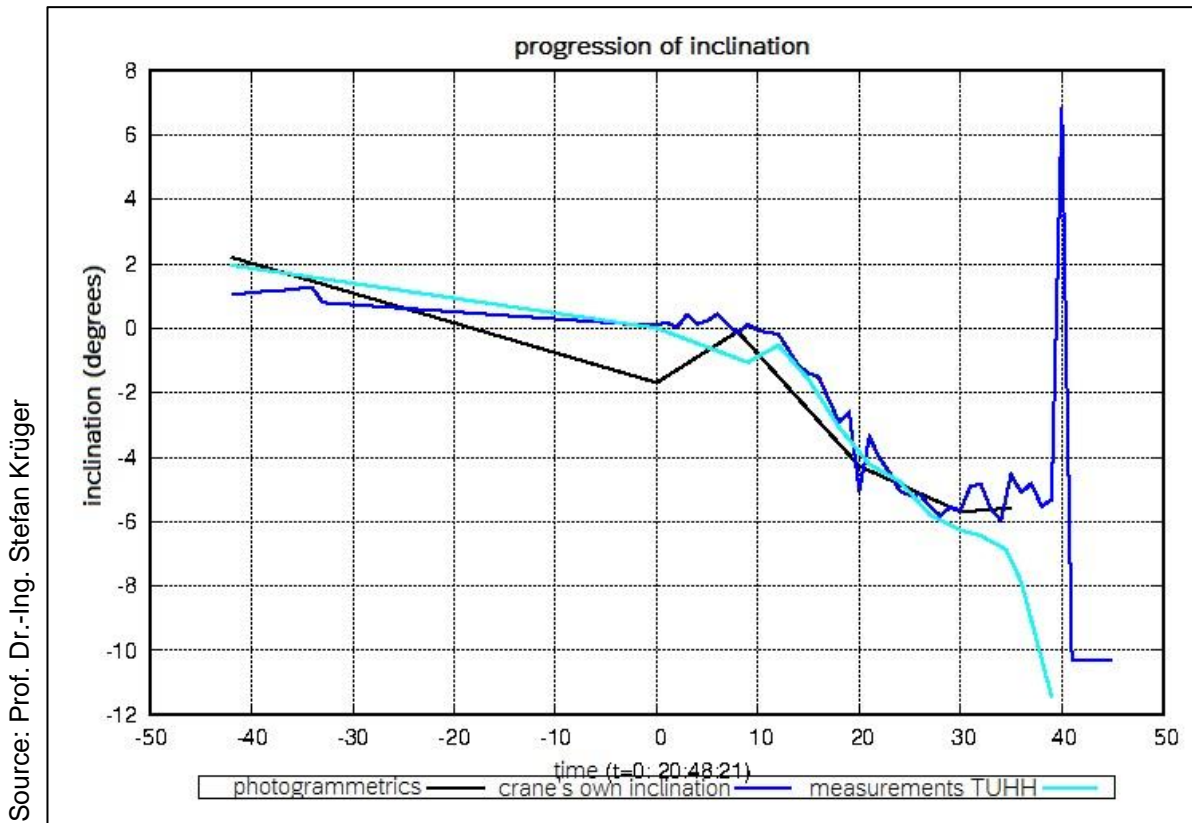

Figure 34: Roll angle over time according to all three measurement methods

The first attempt to stop crane 2 was made 15 s after it was set in motion. The control lever was (unsuccessfully) moved to the neutral position for this purpose. Figure 34 shows that the JUMBO VISION was already heeling by about 1-2°, i.e. the limit for the maximum permissible transverse surface inclination for operating the crane may already have been exceeded.

Both the heeling angles measured by Wiggenhagen and those measured by Krüger now confirmed the tendency of the values of crane 2's inclination sensor, giving additional numerical values. It is therefore reasonable to assume that the phenomenon observed by the master when the Liebherr cranes were loaded during the subsequent voyage – that a crane loaded on board takes on an inclination independent of the ship's (see p. 39 f.) – was not present on the night of the accident. This means that on 31 January the crane's inclination sensor did not record values that were grossly different from the inclination of the surface underneath it. According to Liebherr, hydraulic levelling of the wheelset groups can be assumed to be correctly adjusted on a brand-new crane.

3.4.8.2 VDR microphones

The investigators were now also interested in how and what was communicated on the bridge and on deck at the aforementioned times.

Based on the key events, it was found that the VDR time stamp was three seconds behind those of the crane data chips and the surveillance cameras. The two audio files (only one minute long each) of particular interest were the recordings of the central

wheelhouse (bridge) microphone at the time of the accident and of the external microphone closest to the accident (port bridge wing) at the same time.

The two audio files were denoised and visualised using an audio editor, and the two visualisations were then synchronised and compared (see Figure 35). The audio track of the external microphone is shown at the top, and that of the wheelhouse microphone at the bottom. Furthermore, a number of events and time periods were graphically inserted to provide orientation.

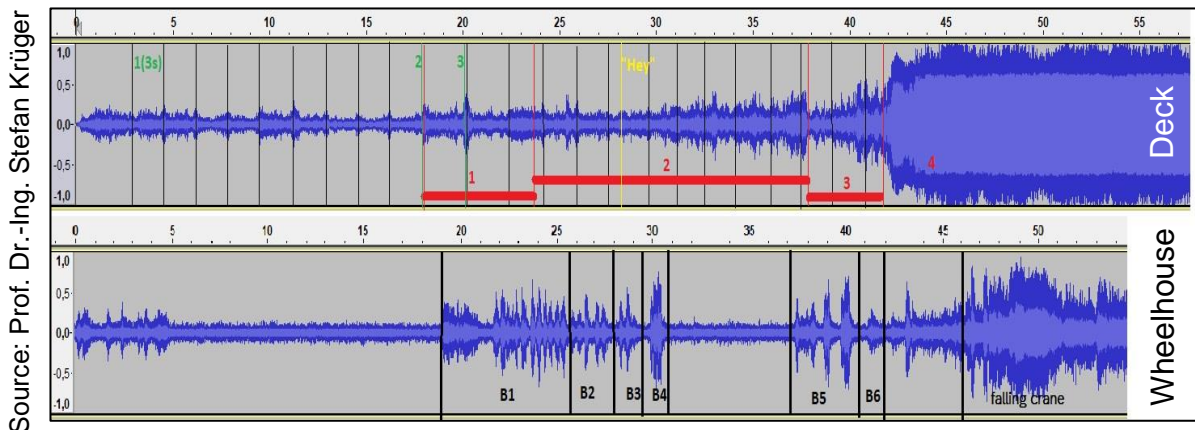

Source: Prof. Dr.-Ing. Stefan Krüger

Figure 35: Visualisation of the two relevant VDR audio files
Recording starts at 20:48:15 VDR time (20:48:18 in all other media)

The **wheelhouse microphone** recorded radio communication between the master, who was there to pump ballast, and the supervising persons on deck (chief mate and port captain). Only the master can be understood, the other side is strongly affected by noise. The bottom part of Figure 35 divides what the master said (with increasing urgency and volume) into six sections (B).

- B1 (about 20:48:34 on the data chips): inaudible UHF call; the master replies: *"Yeah, stop, I'm not that fast! Stop, stop, stop, stop, stop, stop!"*
- B2: *"Let me know first, come on guys."*
- B3: *"We got five degrees!"*
- B4: *"Stop!"*
- Pause
- B5: *"Stop with this crane, stop! Stop!"*
- B6: Inaudible statement (possibly a curse)

The sound of chairs and objects falling can then be heard (this is when the brief but heavy list occurred during which the cranes went overboard). In the following (unvisualised) minute, the master can be heard briefly gathering himself and then immediately ordering a headcount to ensure all on board were present.

At the time at which the master says "We got [sic] five degrees!", all three curves in Figure 34 indicate a heel of almost exactly five degrees (about 25 s after t_0). A heel of 5° corresponds to an inclination of 8.7%. The analogue inclinometer on the bridge can display a maximum heeling value of 5° .

The **external microphone** mainly recorded crane 2's acoustic movement signal, as well as time periods with progressively louder background noise (a grinding, scraping sound), which can be interpreted as spinning crane wheels (with increasing rotation speed and/or in increasing number) and moving steel plates.

To begin with, a vertical black line was inserted in the visualisation of the deck audio file (Figure 35, upper part) for each acoustic movement signal. The signals start three seconds after the beginning of the audio file (at $t_0 = 20:48:21$) and continue almost to the end. It is only absent between 16 s and 20 s (i.e. between 20:48:34 and 20:48:38). Not a black line, but a red and a green line are inserted here. The movement signal actually stops at the exact same moment at which the control lever (and thus the master switch signal) is set to neutral (see Figure 20). However, the rapid change of direction at the beginning (after noticing the wrong direction two seconds after starting up) did not cause the acoustic signal to stop, because the holding brakes did not have enough time to engage (see also chapter 3.4.1.2 Liebherr LHM 550).

Key events were marked with vertical green lines:

- **1**: crane 2 starts up ($\triangleq t_0$);
- **2**: crane operator sets control lever to neutral (no acoustic signal, see above);
- **3**: crane operator gives signal for reversing ($\triangleq t_2$).

The red sections **1**, **2**, and **3** are characterised by progressively louder spinning and scraping sounds. These increase again sharply in section **4**, and then loud, crashing, oversteered noises can be heard, which are evidently the sounds accompanying the fall of crane 2.

At about the time at which the master on the bridge points out the 5° heel – after the last attempt to bring the crane to a standstill (using the support cylinders) had also failed – someone on deck calls out "**Hey!**"

3.4.8.3 Data chips

Liebherr also provided the BSU with a comparison of the progressing angle of heel (recorded by crane 2's inclination sensor) and the master switch signal (see upper two curves in Figure 36). Various events up until the accident are inserted here, too.

Source: Liebherr-MCCtec Rostock GmbH

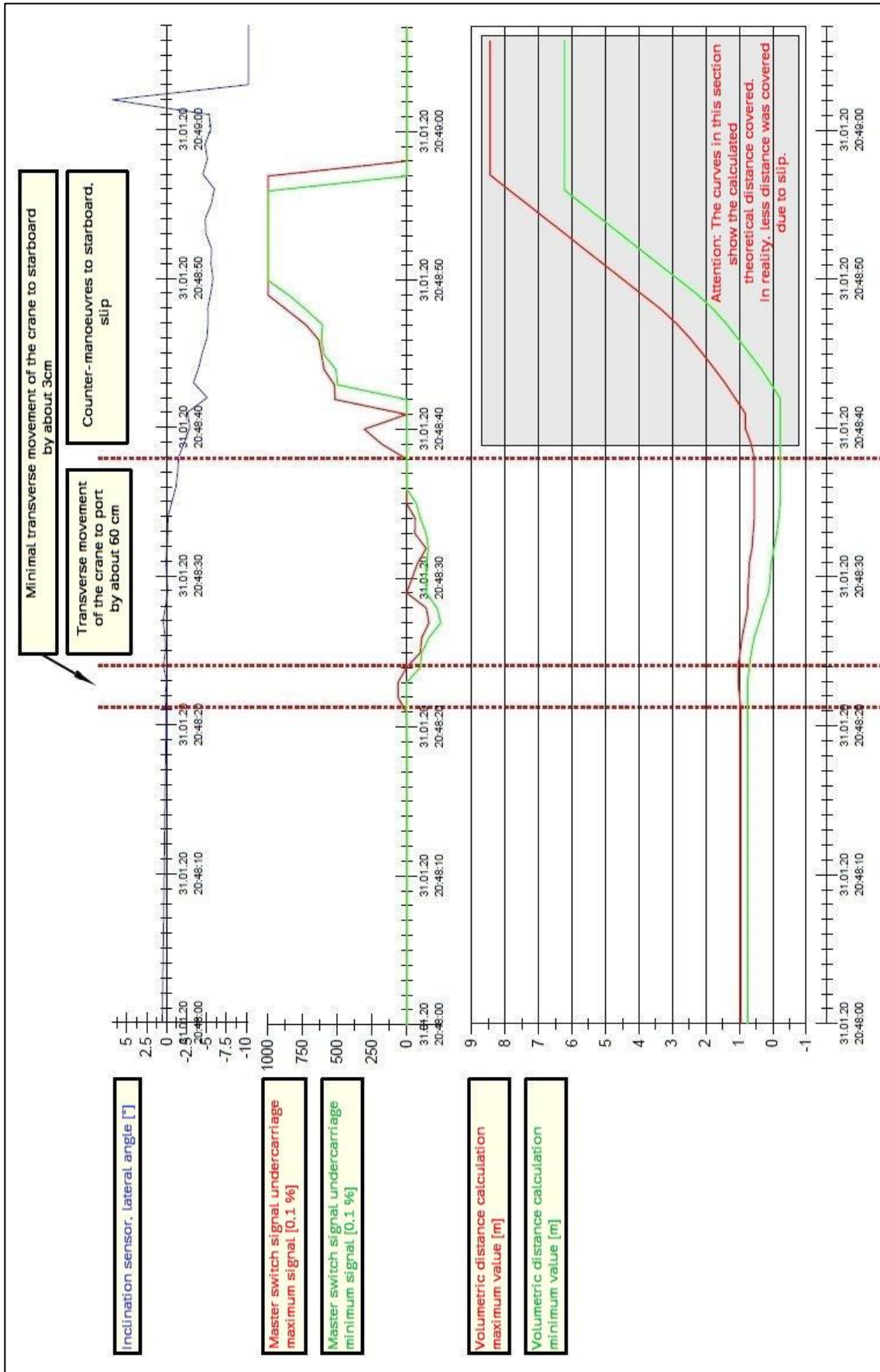

Figure 36: Detail: Inclination, master switch signal, calculated travelled distance

The third, bottommost curve (or pair of curves) in this figure is the calculated distance travelled by the crane. Among other things, this is based on the hydraulic oil volume flow transferred in a certain period of time and its pumping direction, as well as the circumference of the LHM 550's wheels.

The interpretation of this pair of curves is the following:

The initial value is not zero because this diagram does not show the very beginning of recordings, and the crane has been moved before. For the discrepancy between the curves for minimum and maximum value (red and green), see explanation on p. 36.

The pair of curves are an integral, i.e. the integration of a function of the hydraulic oil volume flow, and thus also of the movement. The polarity of the gradient of the curve at any given point therefore corresponds to the direction of the distances covered (forwards or backwards, or landwards or seawards). Accordingly, the calculation shows that the crane moved in the opposite direction again after the negative peak of the curve at 20:48:38 hours, as was intended. It has already been established, however, that this was not the case.

If we assume that the crane's hydraulic drive *operated* in the opposite direction (as planned by the operator), but could not make it change direction, then the phenomenon can be explained.

If (as happened at the time of the peak – see Figure 36, master switch signal at the same time) the control lever (master switch) is set to neutral, then the hydraulic pump for driving the motors also stops transferring oil. The hydraulic motors stop due to the resulting pressure build-up on the opposite side of the motors. This counter-pressure adjusts according to the load required to brake or hold the crane.

In this case, the multi-disc brakes were depressurised and closed under spring load after one second (see Figure 20, light green curve of brake actuation, time: 20:48:37). When starting up in the opposite direction (control lever to the opposite direction; change of polarity on the master switch signal curve), the pump transferred oil and provided the corresponding volume flow to the motors, only now in the opposite direction. This led to the depicted calculated travel distance of the crane to the landward side – which was also the crane operator's objective. However, the crane continued to move to the seaward side.

First, the oil pressure required to move the crane was built up in all drive motors. However, one or more wheelsets then apparently began to spin (wheelslip). This happens when the applied pressure overcomes the frictional forces between the wheels and the surface under them, i.e. when the friction is too low. Here, the lowest friction was between the aforementioned steel plates and the deck surface²⁶.

The volume flow of the pump now increasingly began passing through the drive motors of the wheelsets that were spinning to the landward side (shifting the steel plates lying underneath them to the seaward side). Since this meant that there was too little

²⁶ The coefficient of static friction for “steel on steel” is $\mu \approx 0.3$, and a lot lower in wet conditions ($\mu \approx 0.05$).

pressure on the remaining driven wheelsets to overcome the inclination of the surface, they continued to roll "downhill" instead of in the required direction (and accelerated due to the increasing list). Due to their forced rotation, these wheelset motors – working as pumps at this point – pumped (more and more) *additional* oil, which then flowed (in increasing quantity) through the wheelset drive motors, which therefore spun faster (and faster).²⁷ It is possible that the crane as a whole also slipped during this phase.

The measured distance values after the peak (highlighted in grey in the data analysis) thus only reflect the theoretical travel distance of the crane if

- the total oil volume pumped by the pump during this period had been distributed equally across the motors of all driven wheelsets,
- all wheelsets had had sufficient friction to transmit the drive torque, and
- they had actually travelled the corresponding distance on deck (assuming this distance had been available on the hatch covers).

In reality, however, at least one individual wheelset began spinning, and the steel plates on deck shifted under them. Therefore, the crane continued to roll towards the seaward side, even though the crane's maximum possible driving power was acting towards the landward side. The total driving power available was thus "destroyed" by the spinning wheels (by the wheelslip).

This is the reason why the BSU investigators found a few of the steel plates shifted to the seaward side (see Figure 19). This is where the spinning wheelsets (or at least one) were located that were working towards the landward side and moving steel plates in the process, while the crane as a whole moved in the opposite direction, i.e. in the same direction as the plates. All other wheelsets only rolled and did not move any plates.

This also explains the discrepancy between some of the witness statements (see p. 20). A few witnesses reported wheels turning to the landward side, others reported wheels turning to the seaward side. Both groups were right, depending on where they were standing during the accident, or which of the wheels they were looking at.

Due to the wheelslip, the travel distance curves can therefore only be read correctly up to the negative peak of the curve (time: 20:48:38). Up to this point, the crane travelled at least 60 cm (red curve; beginning of movement up to peak) or at most 120 cm (green curve; same).

3.4.8.4 Expert report on the JUMBO VISION's stability and rolling behaviour

All the findings of the investigation described thus far were used in the preparation of the stability report. This chapter summarises the content of the report without valuation by the BSU.

²⁷ According to Liebherr, an overflow via pressure limiting valves can be ruled out here (due to the low travel speed as well as the deck inclination at this point).

Staff of the Institute of Ship Design and Ship Safety started out by using the ship's framing plan and the stability documents provided by Jumbo Shipping to create a frame shape model that accurately depicted the stability of the JUMBO VISION in the areas relevant to the accident.

The model behaved like the ship. Only the roll period was calculated according to an own, more accurate calculation method and not according to the "*simplified assumptions of the IMO weather criterion, which do not consider the specific individual mass distribution of the actual loading situation at all*"²⁸. According to the more precise model, the roll period for the JUMBO VISION on the day of the accident was 19.81 s (as opposed to the 17.35 s given in the documents, which was the only value available to the crew).

To simulate the effect that crane 2's movements had had on the JUMBO VISION, a sea state programme was used and converted for this purpose. It takes into account the ship's motions in all six degrees of freedom, and the model of the ship's frame was entered into this.

But which actual forces and moments affected the JUMBO VISION during the last movement of crane 2, up until the accident?

First, the stability report identifies the moments that affected the JUMBO VISION before the first stopping attempt (reversing), then it quantifies²⁹ and finally evaluates the results found.

The report emphasises that the characteristics of all heel angle measurements are distinctly non-linear (no increase for a while despite the crane moving, then suddenly a sharp increase, etc.). Therefore dynamic effects (roll moments due to starting and stopping the crane, which triggered an amplifying roll oscillation) must have played a role as much as static effects (heeling moment due to the linear movement of the large crane weight).

The moments thus determined²⁹ were conservative, since influences such as the moment due to the elasticity of the crane (especially its tyres) were consciously not considered.

Summary of the first 13 seconds (the distance values correspond to the minimum and maximum possible distances that the crane was moved according to Liebherr's calculation):

- *The crane accelerates to the landward side at 0.03 m/s² to 0.06 m/s². This induces a **rolling moment to the seaward side**.*

²⁸ Directly quoted sections are in italics and have only been changed with regard to the formatting guidelines for BSU reports.

²⁹ For details see the *Gutachten über das Überbordgehen von zwei Kranen in Rostock am 31.01.2020* [expert report on two cranes falling overboard in Rostock on 31 January 2020, available in German only], which can be downloaded separately at

https://www.bsu-bund.de/DE/Publikationen/Unfallberichte/Unfallberichte_node.html.

- *The crane moves 0.03 m to 0.06 m to the landward side. This induces a **heeling moment to the landward side**.*
- *The crane brakes with 0.03 m/s² to 0.06 m/s², inducing a **rolling moment to the landward side** in the process.*
- *The crane accelerates at 0.03 m/s² to 0.06 m/s² to the seaward side, inducing a **rolling moment to the landward side** in the process.*
- *The crane moves at a constant speed to the seaward side, causing a **linearly increasing heeling moment to the seaward side** in the process.*
- *After 13 s a distance of 0.6 m to 1.2 m to the seaward side has been covered (calculated from the moment the crane started moving). The crane travels at a speed of between 0.06 m/s minimum and 0.12 m/s maximum.*

Next, the report considers the increasing influence of wheelslip on the crane's wheels, in the phase after the direction change had been (unsuccessfully) attempted. Due to the increasing slip, the crane's wheels were able to provide less and less drive torque for stopping the crane.

According to Liebherr, the crane could only have actually toppled after the seaward row of wheelsets had driven over the edge of the hatch cover; so a toppling motion had not played a role during the movement beforehand.

The stowage plan for the voyage indicates a total travel distance until the tipping of the crane of 4.1 m for crane 2, and from the possible travel distances, corresponding travel speeds and transverse accelerations can be calculated.

Summary of the subsequent events (the distance values correspond to the minimum and maximum possible distances that the crane was moved according to Liebherr's calculation):

- *Up to that point (13 s after the crane started moving), the crane has moved by 0.6-1.2 m.*
- *The crane now accelerates to the seaward side because the hydraulics are no longer applying any drive torque, and because the heeling of the ship to the seaward side is further increasing due to this acceleration.*
- *After about 20 s, the crane starts to slip until one wheelset moves over the edge of the hatch cover. By the time it topples, the crane has covered a distance of about 4.1 m.*
- *If we first assume that the crane travelled a distance of 0.6 m by the time of the attempted stop, then 3.5 m would have remained, which the crane then would have covered in 28 s. This would result in a time-average speed of 0.125 m/s. On the other hand, if we assume that the crane travelled 1.2 m up to the time of stopping,*

then 2.9 m would have remained, which the crane then would have travelled or slid in 28 s, which would correspond to an average speed of 0.104 m/s.

To simulate their influence on the JUMBO VISION, the rolling moments thus determined were applied to the computational ship model within the sea state program described above, based on an initial travel distance of 0.6 m and an initial metacentric height of GM = 0.85 m (as provided in the loading documents).

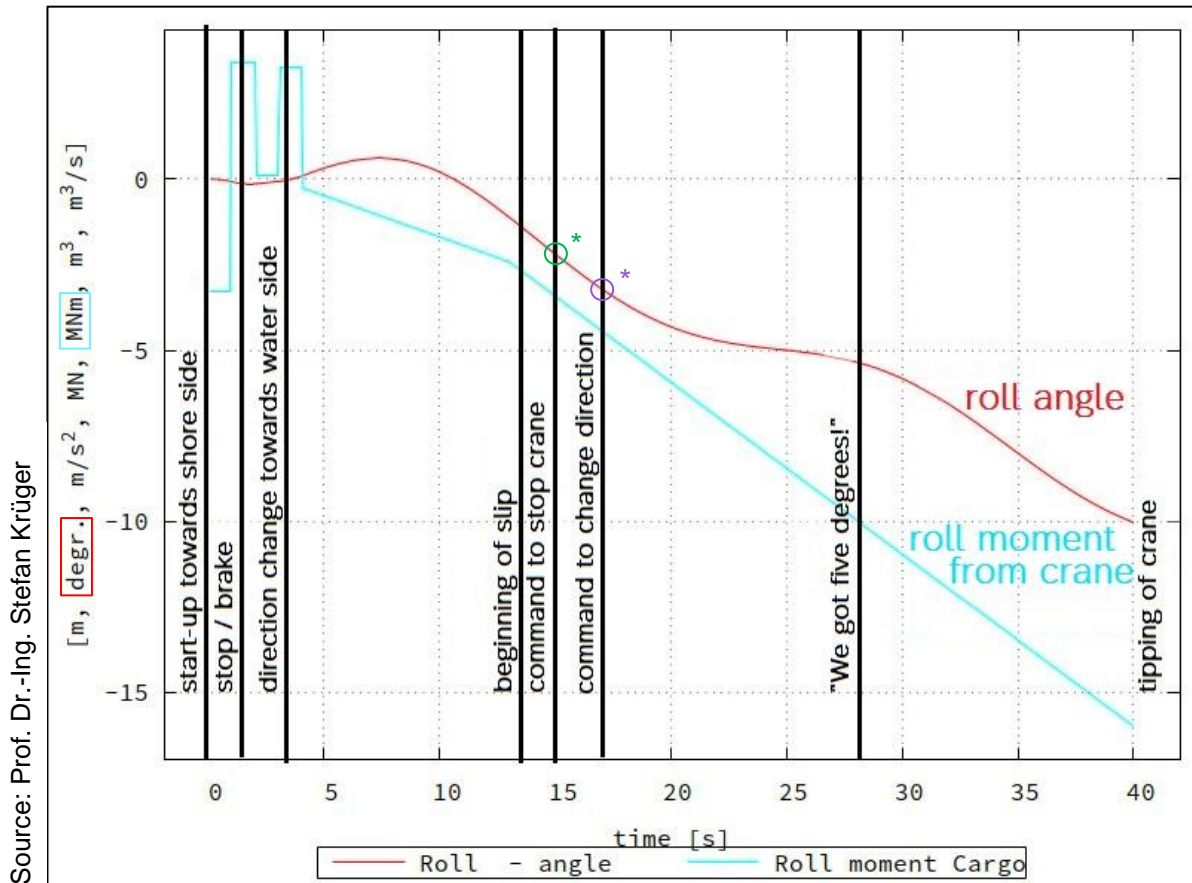

Figure 37: Simulation: Moments acting on the ship and resulting roll angles

The interpretation of Figure 37 shows that at the time the master called out, the simulation also shows a heel of about 5°. It is also clear what effect the rapid direction change (i.e. the crane’s interaction with the ship) had immediately after starting up: One moment towards the seaward side and two moments towards the landward side (light blue curve) acted on the ship as if it were a swing, and triggered an amplifying roll oscillation (red curve). The first almost imperceptible roll to the seaward side was followed by a slightly stronger movement to the landward side. The JUMBO VISION then sharply rolled back to the seaward side, accelerated by crane 2 which was now moving in the same direction. The unsuccessful attempts to stop the crane all happened within the period of this vigorous rollback motion – the first attempt being at about the turning point (*) of the oscillation curve, i.e. when the rolling speed was at its highest.

Put differently, the starting and braking moments evidently fell exactly into phase with the JUMBO VISION’s half natural roll period in her loaded state on that day.

This means that, in addition to the static heel caused by the continuous movement of the crane, the triggered roll oscillation added a dynamic effect and increased the static heel angle against which the drive of the crane had to "work". This also explains the previously observed non-linear pattern of the measured heeling values (see Figure 34).

At the time of the unsuccessful attempt at a direction change after 18 s (*), the simulation calculated an effective heel angle (static angle plus roll acceleration component) of 3.7°, i.e. 6.5%. This is more than three times the maximum permissible transverse surface inclination of 1.15° specified by the manufacturer (even if a slight increase in this value due to the missing counterweights is considered).

The comparison with the other measurement methods of the JUMBO VISION's heeling curve shows that the simulation (red curve) reflects the rolling behaviour of the ship in the given time segment to a good degree of accuracy (Figure 38). The simulation and readings also confirm that the ship's roll period was indeed closer to the value determined by the TUHH (19.81 s) than that calculated using the IMO weather criterion (17.35 s; see also p. 55).

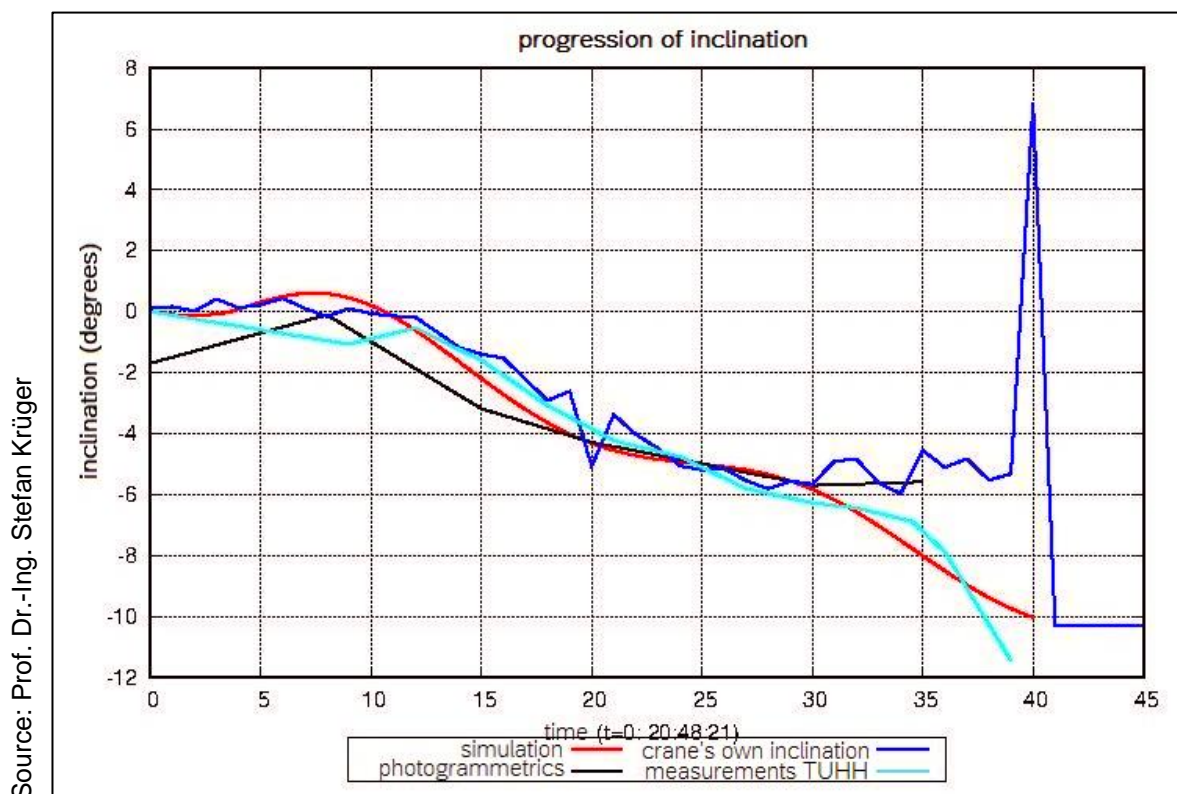

Figure 38: Roll angle over time according to all three measurement methods plus simulation values

The stability report then goes on to examine the influences of

- a greater theoretical travel distance of the crane;
- a higher initial stability;
- a higher initial angular velocity of the rolling motion, and
- a lower initial angular velocity.

However, all of these calculations lead to significantly less relevant results²⁹. Compared to the simulation curve shown in Figure 38, either phase and/or amplitude correspond far less to the heeling curve measured by the IPI (Figure 38), or they show almost no influence on it at all. Therefore, these control calculations confirm the assumptions made at the beginning regarding initial stability and crane travel distance, as well as the values shown in Figure 38.

To establish whether the basic assumption (that a roll oscillation was triggered at all) was correct, the institute carried out a comparison measurement with an electronic precision inclinometer (resolution accuracy $2/100^\circ$) on board another ship. This was a different type of ship with different stability characteristics (e.g. $GM > 3$ m, i.e. considerably greater), and the crane was only moved in a longitudinal direction. But the crane that was loaded was also a LHM 550. The measurements revealed a small but significant effect on the rolling behaviour (i.e. in transverse direction) of the ship, even when the crane was moved in a longitudinal direction. The movement of a crossbeam on the ship's cargo-handling gear from port to starboard also triggered a slight roll oscillation. Accordingly, these measurements confirmed the direction and quality of the assumptions and calculations above.

In the last chapter of the stability report, various prerequisites that did not exist on the day of the accident are examined, to determine whether and how the accident on board the JUMBO VISION could have been avoided. As regards the basic prerequisites, Krüger writes:

Our calculations indicate that the accident was mainly due to insufficient stability management during the movement of the crane. The retrieval of the stabilising pontoons reduced the stability of the ship to an extent that moving the crane was hardly possible while complying with the manufacturer's limit of an inclination of 2% during movement.

In principle, the course of the accident leads us to conclude that the ship's command cannot have known that the manufacturer's limit for moving the crane sideways had already been exceeded when a static heel angle of 1.15° was reached.

This is also evident to us from the fact that the attempted stopping of the crane was not for reasons of stability or because a critical angle of heel was exceeded, but rather because an obstacle (lashing equipment) obstructed the crane's further movement (see testimonies of the port captain and crane operator). The master switch signal shows that the stopping of the crane for this reason was initiated about 15 s after its start-up. The audio recordings indicate that an instruction to slow down the crane was only given from the bridge after 21 s. Moreover, it is not apparent from the remark from

the bridge (that a heel of 5° had been reached) that the people involved were aware that such an angle of heel was already so critical that the crane almost inevitably had to go overboard.

This overall situation is also supported by the fact that the slewing of the ship's cargo gear a moment earlier had already produced an angle of heel that was considerably greater than the manufacturer's limit value permitted for movement of the crane at a transverse inclination.

Therefore, it is clear that the ship's stability at the time of movement was not in reasonable proportion to the inclination permitted for safe movement of the crane. This allows the conclusion that the accident would definitely have been avoided if the stability of the ship had been greater. This would clearly have been achieved if a stabilising pontoon had still been deployed.

It is conceivable that retrieving the stabilising pontoons was not possible due to operational processes after the two cranes had reached their final stowage position. In this case, it would not have been possible to influence the stability of the ship in any other meaningful way. The reduction in stability should have meant that special measures would become necessary, to ensure the safe movement of the crane even under these circumstances. However, the course of the accident suggests that such measures were not taken. We will therefore go on to examine what further options would have been available to reach the final stowage position of the crane safely, even with the existing stability of the ship.

In principle, Krüger considers it necessary to carefully and constantly monitor the ship's inclination even in the case of less sensitive loading conditions (i.e. accurate stability management using an electronic precision inclinometer).

The simulation model was used to investigate possible further measures and scenarios that would have been conceivable or applicable on the night of the accident:²⁹

- The brief inadvertent movement to the landward side caused a negative effect, *"which can be expressed as approximately 20 cm initial stability of the ship"*. Nevertheless, it is unlikely that eliminating this rather significant effect would have resulted in the crane stopping at first attempt, since the JUMBO VISION would have had a heeling angle of 2.07° even then, and the significant contribution of other influences such as wet hatch covers and wheelslip would have contributed to the accident. It was concluded that the incorrect start-up had also contributed to the course of the accident, but was not the sole cause of it.
- The next step was to simulate the effect of a pre-existing heel of 1° to the landward side. If the course of the accident had played out exactly the same, a heel of 2.23° would have resulted from inadvertently starting up to the landward side. Stopping the crane would possibly already not have been possible at this stage, and it would likely have fallen onto the pier.

- The last question is whether it would have made a difference if the crane operator had given the parking brake the time to fully engage. However, assuming that this would have brought the wheels to a standstill at all, braking would have produced an additional moment that would have acted on the crane at exactly the time of the maximum roll acceleration to the seaward side, resulting in a heeling angle of 5.79°. Although this would not have been enough to cause the entire crane to topple over, it is highly likely that it would have continued to slide due to its initial acceleration and the prevailing surface conditions, further increasing the angle of heel in the process, and ultimately possibly still going overboard.

From these calculations Krüger concludes that, under these circumstances, the crane was inevitably going to go overboard after starting to move, and that only "*adequate stability management*" could have prevented the accident. This would have meant continuous and precise monitoring of the vessel's inclination and extremely careful movement of the crane. The inadvertent start-up in the wrong direction would have been irrelevant in this case.

According to the stability report, if the JUMBO VISION had had greater stability, this would have had at least a positive influence on the course of the accident, and would possibly even have prevented it. The "*unfavourable surface conditions*" additionally "*facilitated*" the accident.

3.4.9 Hypothesis 8: Driven wheelset spinning / wheelslip

At the same time as Krüger's extensive analysis of the interaction between the LHM 550 and the JUMBO VISION's rolling behaviour, the BSU commissioned another independent expert report, which examined the LHM 550's hydraulically driven running gear and the associated processes during the accident in greater detail³⁰.

3.4.9.1 Expert report on the characteristics of the LHM 550's hydraulic drive unit

Head of the Department of Marine Engineering at the TUHH, Prof. Dr.-Ing. Christopher Friedrich Wirz, who has years of experience in the development and design of hydraulic drive systems, examined the following question for his report:

What caused crane 2 to become uncontrollable and fall overboard?

The findings of the hydraulics report have been incorporated into the description of the LHM 550's drive system (see chapter 3.4.1.2). Wirz also describes the basic functioning of the LHM 550's hydrostatic (hydraulically driven) propulsion unit using the simplified example of a closed hydraulic circuit with two motors connected in parallel. He emphasises the following physical prerequisites in the process:³¹

³⁰ Referred to hereafter as "hydraulics report".

³¹ For details see *Gutachten / Analysebericht zum Zwischenfall auf M/V Jumbo Vision im Rostocker Hafen im Januar 2020* [expert/analysis report on the incident on the MV JUMBO VISION in the port of Rostock in January 2020, available in German only], which can be downloaded separately at https://www.bsu-bund.de/DE/Publikationen/Unfallberichte/Unfallberichte_node.html.

- The pressure drop (pressure difference before/after the motor) is always the same for both motors.
- If both motors are exposed to the same load, this results in equal torques and rotation speeds.
- If only one of the motors is exposed to a load and the other is idling, then the oil volume flow follows the path of least resistance and only passes through the idling motor. Consequently, this motor now rotates at twice the rated speed while the one exposed to the load stops.
- If one of the motors is driven by an external force, it will act like a pump and build up an oil volume flow which is fed to and then drives the other motor.

Applied to the LHM 550 (i.e. to six motors connected in parallel instead of two), this means that all driven wheelsets deliver the same torque if all of them have traction. If one of them loses grip, then the driving pressure difference is lost at its drive motor, and consequently also at all other wheelsets (see above). If, additionally, the surface under the crane happens to be inclined, then the crane can roll freely. The five remaining, rolling wheelsets (or their motors) will then act like pumps, and discharge the oil volume flow they are pumping through the spinning wheelset. This in turn will then rotate at five times the speed (and subsequently, as the volume flow increases, faster and faster). Wirtz: *"The crane's drive can then no longer counteract the accelerating external force with a braking effect."*

Next, the influence of the LHM 550's mechanical holding brakes is investigated. As described in chapter 3.4.1.1, these are spring-loaded and closed according to the "normally closed" principle, unless the crane is moved or they are actively actuated and opened. They are *"normally designed in a way that they can bring the moving vehicle to a standstill."* Opening the brakes against the spring with the pump's flow rate is a relatively fast process. On the other hand, closing them, where the spring must push the oil from the brake cylinder back into the system tank, takes longer (about 0.3 s). As already discussed, the control lever must be released, i.e. remain in the neutral position, for an appropriate amount of time for this to come into effect. This remains true if operating pressure is lost due to the effects described above.

The next section of the hydraulics report deals with the environmental and boundary conditions at the time of the accident. Among others, the following issues are discussed:³¹

- the critical values for surface inclination when moving the crane longitudinally or transversely: these result from a shifting of the centre of gravity and a subsequent uneven load distribution on the wheelsets;
- a possible tilting over the narrow side of the running gear: this did not happen, as according to information from Liebherr, it can only be expected on an inclined surface of 11-12% ($\cong 4.95\text{-}5.4^\circ$);

- the time it takes for the wheels to be fully decelerated/braked after the control lever is set to neutral: 1 s system-inherent deceleration + about 0.3 s duration of the closing process of the brake cylinder = about 1.3 s;
- the surface conditions: steel plates under the running gear; these and the deck were wet from rain, and also (unevenly) sandy in places.

The next section deals with the interpretation of the course of the accident. First, the vertical force (weight) acting on each wheelset is roughly calculated, as is the corresponding coefficient of friction that must be overcome for at least one wheelset to spin when the crane is on a level, dry and clean surface.³¹

Based on these values, the actual height of the cranes' centre of gravity as well as the dynamics of the process (starting, braking, rolling movements of the ship) are included. Thus, the "top" wheelset row on the inclined ship was relieved of up to one third of the originally acting vertical forces. Depending on the literature source, even the dry coefficient of friction may already have been undercut here.

However, the prevailing conditions additionally affected events. The surface was wet. In addition, an amplifying roll oscillation had been induced, resulting in an angle of inclination at which at least one of the "upper" driven wheelsets apparently overcame the static friction between it and the surface (reduced by the circumstances already discussed), and spun.

As explained in the introductory section of the hydraulics report, the spinning of even one wheelset leads to the loss of the entire driving or holding force. This means that the crane then has no choice but to roll in the direction of the inclination with its remaining wheels. Although the holding brakes alone could possibly cause the crane to slow down in such a case, an attempt at reversing (i.e. to get the crane drive to work against the direction of movement) would be doomed to fail.

Accordingly, the report summarises the most probable course of the accident as follows:

- The various attempts to start and stop crane 2 unfortunately "hit" the ship's half natural roll period, triggering an amplifying roll oscillation.
- While the crane was moving to the seaward side, a roll angle (i.e. surface inclination) was reached that was sufficient to cause one of the "upper" driven wheelsets to spin.
- As a result, the entire drive torque was lost. While the spinning wheelset rotated at a high velocity towards the landward side, the other wheelsets (and with them the entire crane) continued to roll powerlessly in the direction of travel.
- A direction change was technically no longer possible.

- Increasing movement towards the seaward side caused the ship's angle of inclination to increase further, until the crane rolled over the edge of the hatch cover and fell into the water.
- The resulting extremely heavy heel then caused crane 1, which had been stationary until then, to also slip overboard.

3.4.10 Hypothesis 9: Inadequate communication

From the BSU's point of view, the two expert reports raised various questions concerning the communication regarding the transport and loading of the two cranes.

For proper stability management, as explained in the stability report, the involved parties on board the JUMBO VISION would have needed to know the limits of the LHM 550's running gear. However, they were apparently not aware of a critical transverse inclination value for moving the crane ($2\% \triangleq 1.15^\circ$). The fact that crane 2 was not ordered to be stopped because this value had been reached, but because of an obstacle, suggests this.

An enquiry confirmed that Liebherr had not communicated this value, since allegedly there had been no mention in any of the preliminary discussions of moving the cranes on deck in a transverse direction. There was only to be a longitudinal movement, which would not have created any critical heeling. The position of the steel plates laid out on deck (solely along the centre line) confirms this, they stated.

However, according to the ship, the transverse movement of the crane on deck allegedly had been communicated to Liebherr. Firstly, the exact procedure (including the intended direction of movement) was discussed in advance between the port captain and Liebherr, as well as in the toolbox meetings prior to the loading operations. Secondly, crane 1 had also been moved a short transverse distance after it had been loaded the previous day, which no one had objected to, they stated.

It was not possible for the BSU to resolve the contradictions between these statements conclusively, also because no written records of the toolbox meetings exist. The fact that both sides recall this matter differently shows that there were communication problems, at the very least.

Furthermore, the problem of the two LHM 550 jibs, which could only be stored on deck after shifting the cranes several times, was not taken into account in the loading plan prepared ashore. The same was true for the stabilising pontoons, which could not have been retrieved over the fully secured cranes. With regard to these two points, the ship did not communicate the planned course of action on the day of the accident to Jumbo's planning department. For the crew, it had so far always been sufficient to calculate such operations using the resources available on board.

The BSU is of the opinion that the missing, incomplete or misleading communication of technical values on the one hand and of work procedures on the other also contributed to the accident.

4 ANALYSIS

The investigation revealed the following findings.

4.1 Stability

On the one hand, the JUMBO VISION's *static* stability ($GM = 0.85$ m) theoretically met the criteria for transporting the two cranes by sea, secured and in their assigned stowage positions. The calculation of the mere shifting of the weight of crane 2 on deck, which was carried out on board with the loading computer, confirmed this.

Without knowledge of the *dynamic* effects resulting from moving the crane, and using the means available to them for the calculation, the stability was sufficient from the crew's point of view. Stability is only checked with regard to the safety of the ship, which was not threatened at any time.

On the other hand, the existing stability did not offer a sufficient safety margin to counteract the *dynamic* effects caused by the movement of these high and heavy cranes with their jibs topped. Therefore, the overall stability was insufficient on the day of the accident for the planned course of action. Both the stability report and the "tender" stability behaviour of the ship when her cargo-handling gear was slewed prove this.

4.1.1 Movement sequence

This was compounded by the initial movement sequence (or the accompanying switching speed). In conjunction with the ship's extremely long roll period, it triggered an amplifying roll oscillation that coincided exactly with crane 2's direction of movement. The critical transverse inclination was therefore exceeded very quickly.

4.1.2 Roll oscillation

The induced amplifying roll oscillation was stronger than it would have been in a more favourable stability situation. Greater stability would have resulted in a shorter roll period and smaller roll angles. It is possible that greater stability and a shorter roll period would have resulted in a "rollback moment" with a positive impact at the right time. This would have been the case if the stabilising pontoons could have been left out until both cranes had reached their final stowage positions.

The accident occurred during the first more powerful heeling motion of the triggered roll oscillation. When the weight and stability conditions of the JUMBO VISION changed abruptly due to the cranes going overboard, this caused an interference of the oscillation and ultimately ended it. Since the movement of the crane happened at the same time and in the same direction as this powerful heeling motion (with the disastrous consequences already discussed), the people on board will not have attributed the rolling to an amplifying oscillation.

The strong heeling motion as a result of the roll oscillation does not contradict the *static* heeling angle of 0.4° that was calculated by the loading program on board for the mere transverse movement of the crane's weight by the targeted 30 cm.

4.1.3 Stability management

The accident might have been prevented if proceedings on board had been carried out in the manner described by Krüger (precise and continuous monitoring of the vessel's inclination and extremely careful movement of the crane).

In retrospect, it is impossible to say whether the crane could have been moved to the planned final position in this manner. On the one hand, the static stability calculated in advance was sufficient for the final position. On the other hand, however, the effect of the roll oscillation that would have been induced with every start-up of the crane might have been too great for a movement right up to the edge. In all probability at least the crane would not have been lost.

For such an approach the crew would have needed an electronic precision inclinometer, however, but this is not a standard equipment requirement.

Furthermore, an awareness would have been necessary in the first place that consecutively starting up and braking the cranes could trigger *amplifying* roll oscillations – the more violently (greater in period and amplitude) the more "tender" the ship in its stability. The rapid succession of operating commands, which no one on site found problematic, proves that this was not the case for any of the parties involved. However, the BSU is of the opinion that such knowledge cannot necessarily be assumed – even in the context of good seamanship and heavy-lift shipping. The associated hazards could therefore not necessarily be foreseen, even with reasonable care.

4.2 Crane drive

Due to the triggered, amplifying roll oscillation, an inclination was reached which relieved at least one of crane 2's driven wheelsets to such an extent that it spun. The weather-related surface conditions on deck facilitated this.

Once this wheelset spun, the complete drive torque of the crane was lost. The remaining wheelsets rolled powerlessly in the direction of the inclination, i.e. to the seaward side, pumping additional hydraulic oil into the spinning wheelset in the process, which then rotated faster and faster towards the landward side, shifting the steel plates underneath it.

The attempt to change direction was destined to fail for the reasons mentioned above. Although the holding brakes might have brought the crane to a standstill, they did not have time to engage properly because of the rapid succession of switching commands. However, it is possible that the acceleration of the crane at that moment, then increased by the additional braking torque, would have been great enough to cause it to slide overboard anyway.

4.3 Steel plates on deck

The least friction prevailed between the steel hatch covers and the steel plates ("steel on steel" $\mu \approx 0.3$ or, at worst, "steel on wet steel" $\mu \approx 0.05$). Accordingly, this was the weak spot in terms of friction.

As soon as one of crane 2's wheelset rows had left the plates, different static friction conditions prevailed between the driven wheelsets. The difference in static friction between the "upper" (not exposed to a load) and "lower" (exposed to a load) wheelsets was thus additionally increased, as the latter were now exposed to the greater coefficient of friction of "rubber on steel". This facilitated the loss of static friction in one of the "upper" wheelsets.

4.4 Communication

The findings in chapter 3.4.10 (Hypothesis 9: Inadequate communication) suggest that the accident was probably preceded by a communication deficit.

The ship was not aware of the critical value for a transverse inclination when moving the LHM 550. According to Liebherr, they were not informed that the crane was to be moved in a transverse direction. According to Jumbo and the JUMBSO VISION, however, this had indeed been communicated. It was not possible for the BSU to resolve this contradiction.

Furthermore, the work procedures necessary on board to lay down the jibs of the two cranes and to retrieve the stability pontoons had not been communicated in advance to the cargo planning department ashore.

The BSU believes that these deficits in communication were at least a contributing factor to the accident.

5 CONCLUSIONS

Based on the findings of the investigation and their analysis, the BSU has reached the following conclusions in this case:

- The JUMBO VISION's **stability** was **insufficient** on the night of the accident. Although it would have been sufficient for the sea transport of the fully secured cranes (*static effects*), this was not the case for moving and braking them on deck with topped-up jibs (*dynamic effects*). This is not contradicted by the fact that the crew could not have known this, given the means at their disposal.
- The **stabilising pontoons** had **already** been **hauled in** at the time of the accident. However, the ship's stability margin would have been sufficient to prevent the accident had they been deployed. Yet after completion of the cargo securing operations it would no longer have been possible to retrieve them.
- The **starting and braking moments** of the crane's movement **triggered an amplifying roll oscillation**. Due to the low stability, this was greater in terms of amplitude and roll period than it presumably would have been on previous voyages with similar deck cargo situations. A "tender" ship is altogether more susceptible to rolling movements of every kind, and thus also to the triggering of amplifying roll oscillations.
- Both the **movement sequence** of crane 2 at the very beginning and later its **steady movement towards the outer edge amplified this roll oscillation** unfavourably.
- The **long roll period** also had an accident-promoting effect (no "rollback moment" at the right time).
- Consequently, shortly after crane 2 was started up, an **inclination** was reached **that exceeded the manufacturer's limit for moving the crane**.
- Due to the low friction between the steel plates and the deck, **at least one driven wheelset began to slip**. This wheelset, which subsequently spun faster and faster, additionally consumed crane 2's remaining hydraulic driving power.
- The **critical transverse surface inclination value of 1.15°** when moving the LHM 550 was **apparently unknown on board**. The BSU attributes this to a communication deficit between the parties involved.
- **The ship did not communicate the planned procedure** after loading the cranes (*first* retrieving the stabilising pontoons, *then* moving the cranes on deck) to Jumbo Shipping's planning department.
- The process of **setting down the cranes' jibs** and securing the ship's own cargo-handling gear, as well as the procedure for **retrieving the stabilising pontoons** were **left to the ship**.

- The dynamic effects of **starting and braking the cranes** on deck were **not considered in the preliminary planning**. It is reasonable to assume that the parties involved in the preliminary planning were not familiar with the effects in question.
- Although the accident could theoretically have been prevented if **precise stability management** had been pursued, ships are not equipped with electronic precision inclinometers and crews are not familiarised with the required procedures.

6 ACTIONS ALREADY TAKEN

Prior to the accident, it was common practice on Jumbo Shipping vessels to move cranes such as the LHM 550 on deck after they had been loaded. The following changes have since been introduced:

- As a rule, the movement of cranes on deck is to be avoided.
- However, if special circumstances do require this, then a risk assessment must be prepared beforehand and submitted to the Manager Operations and the Manager QHSE for approval.
- In any event, stop blocks are to be put down at both hatch cover ends (forward and aft), and the cranes are to be secured with mooring lines and winches.

The BSU expressly welcomes the requirement that cranes such as the LHM 550 are no longer to be moved on deck if possible, and has therefore dispensed with issuing a safety recommendation to this effect.

However, the effectiveness of the stop blocks and securing by means of mooring lines should be examined in greater detail (breaking load of mooring lines, lashing angles, attachment points, work safety in the event of a line breaking, etc.). The BSU has no further information on this matter.

7 SAFETY RECOMMENDATIONS

The following safety recommendations do not constitute a presumption of blame or liability in respect of nature, number or sequence.

7.1 Federal Ministry of Transport and Digital Infrastructure (BMVI)

The BSU recommends the following to the BMVI in its capacity as flag state representative in the various committees of the IMO³²:

7.1.1 Outfitting requirement: electronic precision inclinometers

Electronic precision inclinometers, or similar (inertia) systems, should form part of the outfitting requirements for ships of 3,000 GT and above, so as to provide the master and crew with this information in real time.

7.1.2 VDR recordings of roll angles, periods, and accelerations

Actual roll angles, roll periods and roll accelerations should be recorded on ships of 3,000 GT and above that are mandatorily equipped with a VDR, for the purpose of maritime safety investigations.

7.2 Jumbo Shipping Co SA

The BSU recommends the following to Jumbo Shipping Co SA:

7.2.1 Revision of internal procedures relating to the preliminary planning of loading conditions

In all procedures (e.g. in the ISM system) concerning the creation, calculation and preliminary planning of loading conditions and stability documentation, it should be ensured that planners are aware of the processes that take place on board during loading. In particular, this applies to practical issues such as the time at which stabilising pontoons are hauled in, or whether objects must or may still be moved after they have been loaded.

Such information should be updated accordingly and kept up to date. The procedures should be adapted.

³² These safety recommendations correspond in content (in relation to the inclinometer and the VDR recordings) to those for container ships in the joint investigation report of the BSU, the Dutch Safety Board (DSB) and the Panama Maritime Authority (PMA), "Containers on the MSC ZOE lost overboard on 1 and 2 January 2019", available for download at https://www.bsu-bund.de/EN/Publications/Unfallberichte/functions/unfallberichte_table_2020.html?nn=1351146.

The BSU believes that in the light of this investigation, and given that reliable heeling values are also of great importance for safe loading and unloading operations, a repetition of this requirement is appropriate for all ship types of 3,000 GT and above.

7.2.2 Revision of internal procedures relating to communication between ships and personnel responsible for load planning

In all procedures (e.g. in the ISM system) relating to communication between ships and personnel responsible for the creation, calculation and preliminary planning of loading conditions and stability documentation, it should be ensured that

- ships receive all necessary information regarding the cargo, and
- the planning department is fully aware of the manner in which loading and securing operations will take place on board and
- records of preliminary meetings are kept.

Such information should be updated accordingly and kept up to date. Associated procedures should be adapted.

7.2.3 Revision of the risk assessments for the movement of cranes on deck

The risk assessments for operations involving moving cranes on deck should take into account the findings of this investigation report, particularly regarding the triggering of amplifying roll oscillations.

The effectiveness of stop blocks and securing by means of mooring lines should be reviewed in relation to the breaking load of mooring lines, lashing angles, attachment points, work safety in the event of a breaking line and other safety-related aspects. Where necessary, these should be calculated mathematically.

Such information should be updated accordingly and kept up to date. The risk assessments should be adapted.

7.3 Liebherr-MCCtec Rostock GmbH

The BSU recommends the following to Liebherr-MCCtec Rostock GmbH:

7.3.1 Communication of data relevant to shipment

Processes concerning the communication of technical product data to the shippers of these products should be revised. In particular, it should be ensured that all data concerning the movement of their products under their own power are made available to the relevant shore-side and ship-side personnel responsible for cargo planning. Records are to be kept of preliminary meetings.

Such information should be updated accordingly and kept up-to-date. Associated procedures should be adapted.

8 SOURCES

- Investigation file of WSP Rostock
- Written declarations/statements/testimonies
 - Ship's command (master)
 - Deck crew members (officers, ratings)
 - Port captain
 - Crane operator
- Recordings from two surveillance cameras in the port of Rostock
- Expert reports
 - by the head of the Institute of Ship Design and Ship Safety at Hamburg University of Technology (TUHH) on the stability of the JUMBO VISION on the day of the accident (*Gutachten über das Überbordgehen von zwei Kranen in Rostock am 31.01.2020* [expert report on two cranes falling overboard in Rostock on 31 January 2020])
 - by the head of the Department of Marine Engineering at TUHH on the LHM 550's hydraulic system (*Gutachten / Analysebericht zum Zwischenfall auf M/V Jumbo Vision im Rostocker Hafen im Januar 2020* [expert/analysis report on the incident on the MV JUMBO VISION in the port of Rostock in January 2020])
 - by the DWD (official weather report)
- Photogrammetric measurements by the Institute of Photogrammetry and Geoinformation (IPI) at the Leibniz University Hannover
- Documents of the salvage company
- Dive report
- Service report on repair works carried out on the ship
- Navigational charts, BSH
- Newspaper "Täglicher Hafenbericht" ("Daily Port Report")
- Tables of static friction coefficients for various material pairings
- Operating instructions for the LHM 550's remote control
- Oral statement of a Liebherr crane operator (not involved in the accident) on the various safety functions of the LHM 550's remote control
- Explanations of the head of product development, responsible for harbour cranes at Liebherr, provided by phone and email (including recorded data sets from the cranes involved in the accident and travel paths calculated on the basis of those data sets)
- Stability, loading and lashing calculations prepared in advance by Jumbo Shipping for the loading conditions on the day of the accident
- The ship's stability program and/or loading computer
- VDR audio recordings
- Photographs taken by the crew, the stevedoring company, the WSP, and the BSU
- Shipboard calculations relating to the inertia of the anti-heeling system
- Miscellaneous BSU investigation reports

9 ANNEXES

The expert reports accompanying this investigation report

- *Gutachten über das Überbordgehen von zwei Kranen in Rostock am 31.01.2020* [expert report on two cranes falling overboard in Rostock on 31 January 2020] (Stability report),
- *Gutachten / Analysebericht zum Zwischenfall auf M/V Jumbo Vision im Rostocker Hafen im Januar 2020* [expert /analysis report on the incident on the MV JUMBO VISION in the port of Rostock in January 2020] (Hydraulics report),

can be downloaded separately on the website of the BSU (available in German only)³³.

³³ https://www.bsu-bund.de/DE/Publikationen/Unfallberichte/Unfallberichte_node.html.