



REPUBLIC OF THE MARSHALL ISLANDS

Maritime Administrator

STELLAR DAISY CASUALTY INVESTIGATION REPORT

Loss of Buoyancy and Foundering with Multiple Loss of Life

South Atlantic Ocean | 31 March 2017

Official Number: 3486

IMO Number: 9038725



CONDOLENCES

The Republic of the Marshall Islands Maritime Administrator offers its sincere condolences to the families and friends of the 22 individuals who perished in the 31 March 2017 casualty.

ACKNOWLEDGEMENTS

The Republic of the Marshall Islands Maritime Administrator commends the surviving members of the crew of STELLAR DAISY for their dedication to searching for their fellow crewmembers. The Master and crew of SPITHA, and particularly ELPIDA, are also commended for their efforts in searching for and rescuing the surviving members of STELLAR DAISY crew.

The Republic of the Marshall Islands Maritime Administrator thanks the marine safety investigation authorities from the Republic of Korea, the Republic of the Philippines, and the Federative Republic of Brazil, which participated as substantially interested States, and Polaris Shipping Co., Ltd., the Korean Register of Shipping, and Vale SA, which were interested parties, for their cooperation.

DISCLAIMER

In accordance with national and international requirements, the Republic of the Marshall Islands Maritime Administrator (the “Administrator”) conducts marine safety investigations of marine casualties and incidents to promote the safety of life and property at sea and to promote the prevention of pollution. Marine safety investigations conducted by the Administrator do not seek to apportion blame or determine liability. While every effort has been made to ensure the accuracy of the information contained in this Report, the Administrator and its representatives, agents, employees, or affiliates accept no liability for any findings or determinations contained herein, or for any error or omission, alleged to be contained herein.

Extracts may be published without specific permission providing that the source is duly acknowledged; otherwise, please obtain permission from the Administrator prior to reproduction of the Report.

AUTHORITY

An investigation, under the authority of the Republic of the Marshall Islands laws and regulations, including all international instruments to which the Republic of the Marshall Islands is a Party, was conducted to determine the cause of the casualty.

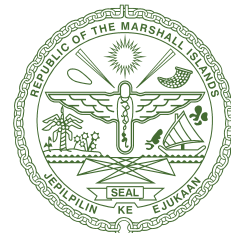

Maritime Administrator

TABLE OF CONTENTS

PART 1: EXECUTIVE SUMMARY	9
PART 2: FINDINGS OF FACT	11
PART 3: ANALYSIS	55
PART 4: CONCLUSIONS	75
PART 5: PREVENTATIVE ACTIONS	77
PART 6: RECOMMENDATIONS	81



PART 1: EXECUTIVE SUMMARY

On 31 March 2017, the 266,141 deadweight ton (DWT), very large ore carrier (VLOC) STELLAR DAISY sank while on a laden voyage from Ilha Guaiba, Federative Republic of Brazil (hereinafter “Brazil”) to Qingdao, People’s Republic of China (hereinafter “China”). At the time, STELLAR DAISY was underway in the South Atlantic Ocean and was more than 1,700 nautical miles (NM) from the coast of Oriental Republic of Uruguay (hereinafter “Uruguay”) and 1,800 NM from the west coast of Republic of South Africa (hereinafter “South Africa”). The water depth in the area was approximately 3,400-3,600 meters (m). Of the 24 crewmembers on board, two were rescued. The other 22 crewmembers are missing and presumed deceased.

The marine safety investigation conducted by the Republic of the Marshall Islands Maritime Administrator (the “Administrator”) determined that the likely direct cause of STELLAR DAISY foundering was a rapid list to port following a catastrophic structural failure of the ship’s hull that resulted in a loss of buoyancy and uncontrolled flooding. The structural failure and flooding are thought to have begun in the No. 2 port water ballast tank (WBT) and then progressed rapidly to include structural failure and flooding in multiple WBTs, voids, and cargo holds. The structural damage was likely due to a combination of factors, including the strength of the ship’s structure being compromised over time due to material fatigue, corrosion, unidentified

structural defects, multi-port loading, and the forces imposed on the hull as a result of the weather conditions STELLAR DAISY encountered between 29–31 March 2017.

The Administrator’s marine safety investigation also concluded that the likely causal factors include:

1. the large port and starboard wing tanks increased the potential for a major structural failure and loss of buoyancy in the event that one or more of these tanks flooded while the ship was in a laden condition;
2. a gap in the additional safety measures for bulk carriers contained in the International Convention for the Safety of Life at Sea (SOLAS), 1974, Chapter XII, regulation 5 which does not require an assessment to ensure bulk carriers of 150 m or more in length of double-side skin construction, designed to carry solid bulk cargoes with a density of 1,000 kilograms per cubic meter (kg/m³) and above, constructed on or after 1 July 2006 with any part of the longitudinal bulkhead located within B/5 or 11.5 m, whichever is less, inboard from the ship’s side at a right angle to the centerline at the assigned summer load line can withstand the flooding of any one wing tank in all loading and ballast conditions; and
3. ineffective assessments of structural damage identified when the ship was in dry dock in 2011, 2012, and 2015 which failed to determine the cause of the structural damage, identify any potential defects with the conversion design, or require the development of appropriate repair plans.



PART 2: FINDINGS OF FACT

The following Findings of Fact are based on the information available to the Administrator.

Ship Details

1. Ship particulars: *see* chart on page 12.

New Construction

2. STELLAR DAISY¹ was built as a 264,165 DWT, single hull, very large crude carrier (VLCC) in 1993 at the Mitsubishi Heavy Industries, Ltd. shipyard in Sapporo, Japan. The ship was designed, built, and classed in accordance with the applicable rules of the ClassNK Classification Society as a crude oil carrier.²

¹ Although the ship was not named STELLAR DAISY until 1 January 2008, it will be referred to by this name throughout the report.

² ClassNK Rules 1991 edition.

3. As built, STELLAR DAISY was longitudinally framed with web frames on 5.95 m centers. The ship’s structure included mild steel and multiple grades of high tensile strength steel.³ Within the cargo length, grade AH high tensile strength steel was used for, among other things, plate for the main deck, side shell, bottom shell, under deck longitudinals, horizontal girders, frames, and oil tight bulkheads. Grade AH36 high tensile strength steel was used for the side shell longitudinals, bottom longitudinals, longitudinal bulkhead longitudinals, and transverse bulkhead vertical stiffeners.⁴
4. There were 15 tanks in the cargo length. Of these, the No. 1 port (P)/center (C)/starboard (S), No. 2 C, No. 3 P/C/S, No. 4 C, and No. 5 P/C/S tanks were cargo oil tanks (COT). The No. 2 P/S and No. 4 P/S tanks were segregated WBTs. The ship’s other WBTs were the forepeak tank (FPT) and the aftpeak tank (APT).
5. In January 2008, Polaris Shipping Co., Ltd. (Polaris Shipping) assumed responsibility for the commercial operation of STELLAR DAISY and Syncro Shipping Co., Ltd. assumed responsibility for the ship’s management in accordance with the International Management Code for the Safe Operation of Ships and for Pollution Prevention (International Safety

³ Steel with a specified minimum yield stress of 235 Newtons per square millimeter (N/mm²) is normal strength structural steel and is referred to as mild steel. Steel having a higher specified minimum yield stress is regarded as high tensile strength steel. High tensile strength steel is commonly marked “AH.” Grades of high tensile strength steel are based on the minimum yield stress. Grade AH or AH32 high tensile strength steel has a minimum yield of 315 N/mm². Grade AH36 high tensile strength steel has a minimum yield of 355 N/mm². See International Association of Classification Societies (IACS), Common Structural Rules for Bulk Carriers and Oil Tankers, Part 1, Chapter 3, Section 2 (1 January 2014).

⁴ Mitsubishi Heavy Industries Co., Ltd., DWT 265,000 Ton Class Ore Carrier (M/V “STELLAR DAISY”) General Arrangement, Drawing JD 07066-H001, Rev. B, dated 21 January 2008 (hereinafter, “Midship Section Drawing”). The Midship Section Drawing was approved by the Korean Register of Shipping (KR) on 23 January 2008. The Midship Section Drawing includes the ship’s original structure and the structure after conversion.

SHIP PARTICULARS

Ship Name
STELLAR DAISY

Registered Owner
VP-14 Shipping Inc.

ISM Ship Management
Polaris Shipping Co., Ltd.

Flag State
Republic of the Marshall Islands

Date of Registry
22 January 2009

IMO No. 9038725	Official No. 3486	Call Sign V7RD9
---------------------------	-----------------------------	---------------------------

Year of Build 1993	Year Converted 2009
------------------------------	-------------------------------

Length x Breadth x Depth
311.89 x 58 x 29.5 meters

Gross Tonnage 148,431	Net Tonnage 44,530	Deadweight Tonnage 266,141
---------------------------------	------------------------------	--------------------------------------

Ship Type
Very Large Ore Carrier
(Converted from a Very Large Crude Carrier)

Document of Compliance
Recognized Organization
Korean Register of Shipping

Safety Management Certificate
Recognized Organization
Korean Register of Shipping

Classification Society
Korean Register of Shipping

Persons on Board
24

Management (ISM) Code). The ship also underwent a change of Classification Society from ClassNK to KR and the ship's registration was changed to the Republic of Korea.

Conversion

6. On 22 July 2008, STELLAR DAISY entered the COSCO Shipyard in Zhoushan, China for conversion from a VLCC to a VLOC. The design work was in accordance with the applicable KR Rules for the Classification of Steel Ships⁵ and was reviewed and approved by KR.
7. The conversion of STELLAR DAISY from a VLCC to a VLOC was a major modification. In accordance with SOLAS, Chapter II-1, regulation 1.3, the ship was required to comply with requirements for ships constructed on or after the date on which relevant amendments entered into force to the extent deemed reasonable and practicable by the ship's flag State, which at the time was the Republic of Korea. The SOLAS requirements that the ship was required to comply with included those addressing subdivision and stability, life saving equipment, additional safety measures for bulk carriers, and the carriage of a voyage data recorder (VDR).⁶
8. SOLAS regulation XII/5.2 requires that bulk carriers of 150 m or more in length of double-side skin construction, designed to carry solid bulk cargoes with a density of 1,000 kg/m³ and above, constructed on or after 1 July 2006 with any part of the longitudinal bulkhead located within B/5 or 11.5 m, whichever is less, inboard from the ship's side at a right angle to the centerline at the assigned summer load line "have sufficient strength to withstand flooding of any one cargo hold to the water level outside the ship in that flood condition in all loading and ballast conditions." Based on a unified interpretation adopted by the International Maritime Organization's (IMO's) Marine Safety Committee (MSC), cargo holds that have a longitudinal bulkhead located outside the lesser of B/5 or 11.5 m do not have to be considered in a flooded condition.⁷ In the case of STELLAR DAISY, only the longitudinal bulkhead for Cargo Hold No. 1 was located within the specified dimension. Therefore, the ship's strength only needed to be considered with Cargo Hold No. 1 flooded in order to demonstrate compliance with this regulation. KR's review of the conversion design included verification that the design complied with SOLAS regulation XII/5.2 when Cargo Hold No. 1 was flooded.
9. A finite element analysis (FEA), which was based on a model of the midship half-breadth of the ship's hull, was completed to support the conversion design approval process and was provided to KR.⁸ The FEA evaluated the stresses on the ship's midship half-breadth (*see Figure 1*)⁹ associated with six independent

5 KR, Rules for the Classification of Steel Ships, Part 3: Hull Structures, and Part 7: Ships of Special Service, Chapter 2 (2007 ed.) (hereinafter, "KR Rules for Steel Ships").

6 The applicability of the SOLAS regulations regarding subdivision and stability and additional safety measures for bulk carriers will be addressed separately. The ship's flag State at the time of conversion did not require that the existing life boats be replaced with a free-fall life boat. *See* SOLAS regulations III/1.4.2 and 31.1.8. The flag State at the time of conversion also determined that the ship's existing simplified voyage data recorder (S-VDR) did not need to be replaced with a VDR.

7 IMO MSC circular MSC/Circ.1178—Unified Interpretations of SOLAS Regulations XII/4.2 and 5 (hereinafter, "MSC/Circ.1178").

8 Joong Ang Ship Technology Ltd., 258,000 DWT ORE Carrier (M/V STELLAR DAISY) Analysis of Cargo Hold Structure, October 2007 (hereinafter, "Analysis of Cargo Hold Structure"). The Administrator received the Analysis of Cargo Hold Structure from KR as part of the Administrator's investigation. The Administrator had this document, which was prepared in Korean, translated into English. All references to the Analysis of Cargo Hold Structure will be to the English translation.

9 The midship half-breadth is the portion of the ship extending athwartships from the centerline to the portside side shell and longitudinally from frame No. 61, which is located at the middle of the No. 4 Cargo Hold, to frame No. 79, which is located at the middle of No. 2 Cargo Hold. Midships is just forward of frame No. 67. *Ibid.*, p. 15. *See also* Mitsubishi Heavy Industries Co., Ltd., DWT 265,000 Ton Class Ore Carrier (M/V "STELLAR DAISY") General Arrangement, Drawing JD 07066-B001, dated 2009.01 (hereinafter, "General Arrangement Drawing"). This General Arrangement Drawing was approved by KR on 16 January 2009.

loading conditions: laden with high density cargo;¹⁰ laden with low density cargo;¹¹ in ballast;¹² No. 2 P WBT tank test;¹³ No. 3 P WBT tank test; and No. 2 Cargo Hold flooded.¹⁴ The FEA assumed all the scantlings were as original.¹⁵

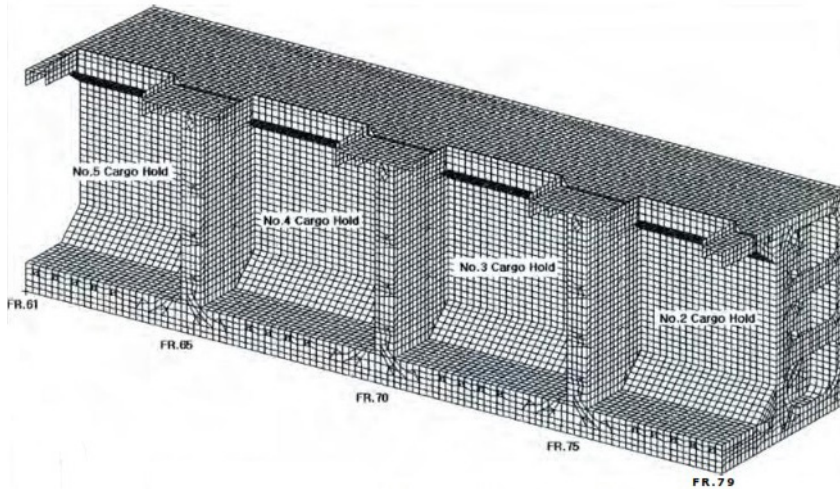

Figure 1: Midship half-breadth of STELLAR DAISY's hull that was modeled for the FEA. Note that Cargo Holds Nos. 3, 4, and 5 in the drawing refer to Cargo Holds Nos. 3F, 3A, and 4 on the General Arrangement Drawing.¹⁶

10. The FEA identified high shear stress in the web frame in way of where the new underdeck structure landed on the longitudinal bulkhead when the ship was loaded with a high density cargo. This was addressed by modifying the web frame to replace the existing grade AH plate with grade AH36 plate between longitudinal bulkhead longitudinals Nos. 5-7. The FEA also identified an area where the stress exceeded the allowed stress in the web frame in way of where the top of the hopper plate landed on the longitudinal bulkhead. The stress in this area was reduced by modifying the conversion design to include the installation of a girder at longitudinal bulkhead longitudinal No. 25 in each of the P/S voids and WBTs within the cargo length;¹⁷
11. A buckling analysis of major structural members under all loading conditions was also conducted as part of the FEA. This analysis determined the compression forces on all the major structural members were within allowable limits except for those on the web frames and the transverse bulkheads.¹⁸ As a result,

10 High density cargo was assumed to have density of 3.0 metric tons per cubic meter (MT/m³). Analysis of Cargo Hold Structure, p. 32.

11 Low density cargo was assumed to have a density of 2.0 MT/m³. *Ibid*, p. 33.

12 The ballast condition assumed No. 2 and No. 4 WBTs P/S were full. *Ibid*, p. 37.

13 For the tank test, it is assumed that the WBT was filled to 100% capacity. *Ibid*, p. 37.

14 The reconfiguration of the ship is discussed in Findings of Fact 15 and 16.

15 KR informed the Administrator's casualty investigator that the decision to assume the scantlings were as original was based on the determination that the thickness of the structural members at the time of the conversion was within the wear limits prescribed in KR Rules for Steel Ships, Part 1, Annex 1-5, Table 1. This is consistent with IACS Unified Requirement (UR) S11—Longitudinal Strength Standard and IACS Common Structural Rules for Bulk Carriers, Chapter 3, Section 2 (Rev. July 2008). It is further noted that KR's guidance for conducting finite strength assessments includes requirements for considering the effect of corrosion on fatigue life and local notch effect. KR Rules for Steel Ships, Part 3, Annex 3-3.

16 Analysis of Cargo Hold Structure, p. 15.

17 The girder consisted of a 1200 x 14 millimeter (mm) web and a 200 x 20 mm flange constructed using AH plate. See Midship Section Drawing and Analysis of Cargo Hold Structure, p. 53.

18 Analysis of Cargo Hold Structure, pp. 95-108.

modifications were made to the design of these structural members. Based on an additional buckling analysis that considered the modifications to the design, it was concluded that the compression forces on the web frames and transverse bulkheads between WBTs and voids were within allowable limits under all the loading conditions that were evaluated.¹⁹

12. The FEA concluded that although there were a number of areas where the stress was high, the conversion design was within the allowable limits for all loading conditions.²⁰
13. As part of the Administrator's marine safety investigation of the loss of STELLAR DAISY, Bruce S. Rosenblatt and Associates, LLC (BSR) was contracted to conduct an independent third-party FEA of the conversion design. The BSR FEA noted there was a difference between the cargo pressures on the boundaries of the cargo hold calculated using the KR Rules for Steel Ships and those calculated using the IACS Common Structural Rules, January 2006 edition as revised through Corrigenda 5 (CSR 2006, Corr.5) that were applicable when the design work for the conversion was being completed.²¹ These differences are most significant nearer the top of the cargo pile (see Figure 2). Therefore, load cases were developed and analyzed using both sets of rules. No areas of concern were identified with either load case. BSR did question whether these calculated pressures were adequate given that the pressure on the longitudinal bulkheads and supporting structure would increase due to the increased static list resulting from the flooding of wing tanks.²²

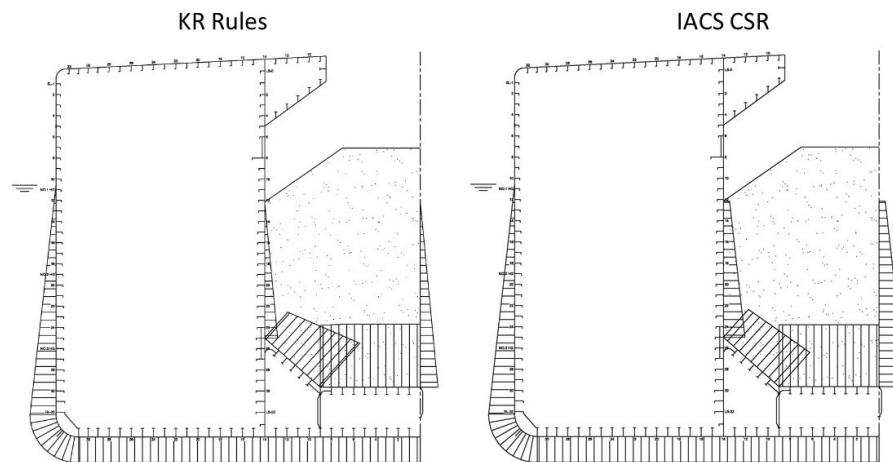

Figure 2: Scaled graphic representations of the static cargo pressures on the cargo hold boundaries based on KR Rules for Steel Ships (left) and IACS CSR 2006, Corr.5 (right). The pressures on the transverse bulkheads are shown to the right of the cargo pile.

19 *Ibid*, pp. 109-114. The revised design details were included in Rev. A of the Midship Section Drawing.

20 *Ibid*, p. 114.

21 See KR Rules for Steel Ships, Part 3, Annex 3-2 and IACS CSR 2006, Corr.5, Chapter 4, Section 6, paragraph 1.2.1 The formula in the KR Rules for Steel Ships and IACS CSR 2006, Corr.5 include a coefficient intended to reduce the magnitude of the calculated static cargo pressure for surfaces that are at some angle from the horizontal. Based on KR Rules for Steel Ships, the value of this coefficient is 1.0 for surfaces that have an angle from the horizontal (β) that is less than or equal to 40° . For angles greater than 40° and less than 80° , the value of the coefficient decreases linearly ($k=1.4-0.01\beta$). For angles equal to or greater than 80° , the value of the coefficient remains constant at a value of 0.6. Because the coefficient is squared, the pressure on vertical bulkheads is minimized. In contrast, the value of the coefficient used by the IACS CSR 2006, Corr.5 is a function of the angle of the surface being considered and the horizontal plane (α) and the angle of repose of the cargo (ψ) using a non-linear formula ($K_c = \cos^2 \alpha + (1 - \sin \psi) \sin^2 \alpha$). The practical difference is that static cargo pressures on longitudinal and transverse bulkheads calculated using the KR Rules for Steel Ships are less than those calculated using the IACS Common Structural Rules. See KR Rules for Steel Ships, Part 3, Annex 3-2 and IACS CSR 2006, Corr.5, Chapter 4, Section 6, paragraph 1.2.1.

22 Although there are differences between the KR Rules for Steel Ships and IACS Common Structural Rules, using either rule the calculated pressure of cargo at any point on the longitudinal bulkhead will increase as the angle of list increases. Although the change of pressure is not significant at small angles of list, it becomes more significant as the angle of list increases.

14. In accordance with the KR Rules for Steel Ships that were applied by KR during its review and approval of the conversion design, a fatigue strength assessment was not required to be conducted.²³ KR informed the Administrator’s casualty investigator that the decision to not conduct a fatigue strength assessment was based on several factors, including its determination that the scantlings of the deck and hull plate and the associated longitudinals had been verified by ClassNK when the ship was built in 1993 and had not been changed while the ship was in service as a VLCC. KR reported that the decision to not require a fatigue strength assessment also took into consideration its determination that the long-term distribution of stress range, particularly for the bottom and side longitudinals in the P/S WBTs and P/S voids in the cargo length, was the same pre- and post-conversion. KR’s decision was also based on its determination that loads associated with the hull girder bending, draft, and water head in the WBTs had not changed significantly.
15. During the conversion, each of the center COTs were reconfigured into cargo holds. The No. 3 C COT was converted into two Cargo Holds, No. 3F and No. 3A.²⁴ This was accomplished by fitting transverse bulkheads at frames 70 and 70.5. Cargo Holds Nos. 1, 2, 4, and 5 were fitted with two cargo hatches and Cargo Holds No. 3F and No. 3A were each fitted with one cargo hatch (see Figure 3). The volume in cubic meters (m³) of each cargo hold is shown in Table 1.

Table 1: Cargo Hold Volume	
Cargo Hold	Volume (m ³)
No. 1	25,104.4
No. 2	27,315.6
No. 3F	16,389.3
No. 3A	16,389.3
No. 4	27,315.8
No. 5	28,524.3

²³ In accordance with KR Rules for Steel Ships, Part 3, Annex 3-3, paragraph 1, a fatigue analysis was not mandatory except for ships designed and built to comply with the requirements of the KR Rules for Steel Ships, Part 11—Common Structural Rules for Bulk Carriers, or Part 12—Common Structural Rules for Double Hull Tankers.

²⁴ Unless stated otherwise, the cargo hold numbers are based on the General Arrangement Drawing.

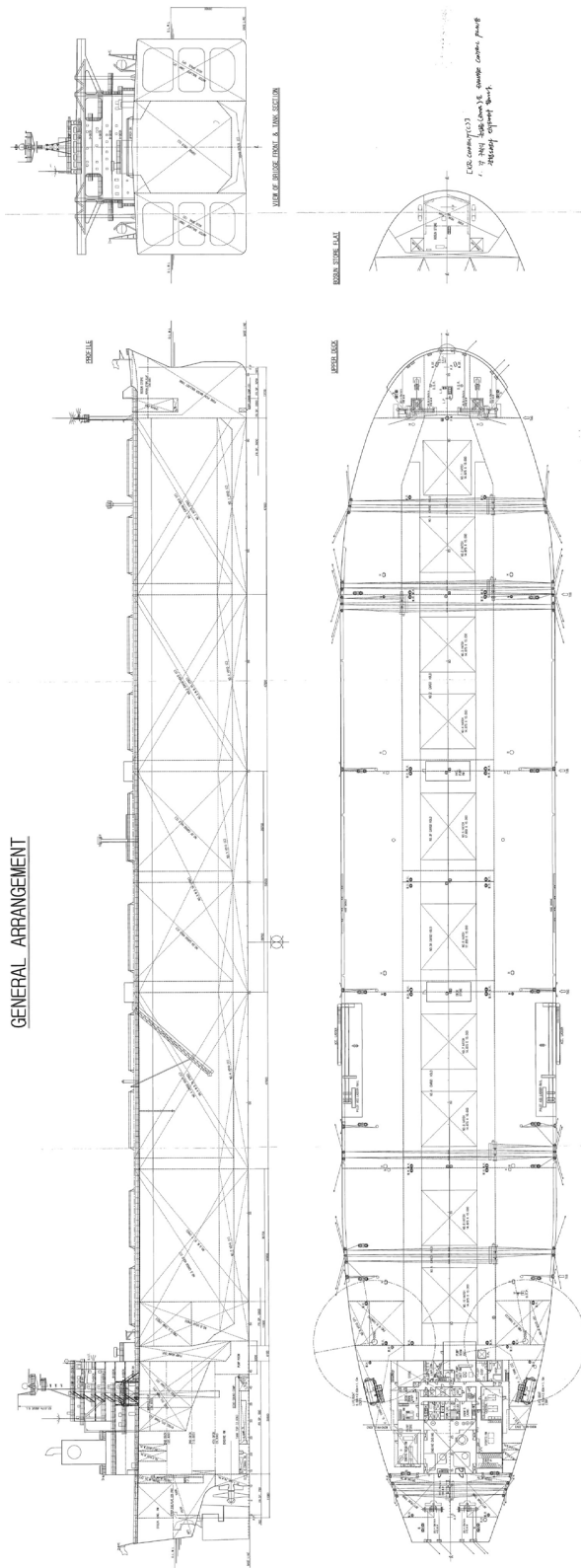

Figure 3: STELLAR DAISY's general arrangement. (Source: General Arrangement Drawing.)

16. The No. 1 P/S COTs and P/S slop tanks were converted into voids and the No. 3 P/S and No. 5 P/S COTs were converted into WBTs. The No. 2 P/S and No. 4 P/S WBTs, which had been segregated WBTs when the ship was in service as a VLCC, remained WBTs (*see Figure 3*). The capacity of each WBT in metric tons (MT) of salt water is shown in *Table 2*. The No. 2 P/S WBTs, the No. 4 P/S WBTs, the FPT, and the APT were the ship's primary ballast tanks. The No. 3 P/S WBTs were used when necessary to reduce the ship's air draft when loading or discharging cargo.²⁵ Each WBT and void was hard coated, or painted. In addition, each WBT was fitted with zinc anodes to protect against corrosion.²⁶

Table 2: WBT Capacity

WBT	Capacity (MT)
FPT	8,041.125
No. 2 S	24,081.248
No. 2 P	24,081.248
No. 3 S	30,065.813
No. 3 P	30,065.813
No. 4 S	23,729.058
No. 4 P	23,729.058
No. 5 S	14,992.470
No. 5 P	14,992.470
APT	3,274.055

17. The structure of the main deck, side shell, and the bottom shell in way of the voids and WBTs on the port and starboard sides was not changed during conversion. In addition to removing cargo piping and other systems required for service as a crude oil tanker, the conversion required the completion of major structural work including:²⁷
- installation of inner bottoms,²⁸ hoppers, and closed top side voids in each of the cargo holds (*see Figure 4*)²⁹;
 - reinforcement of the transverse bulkheads between cargo holds by installing a second plate (*see Figure 5*);
 - reinforcement of the longitudinal bulkheads between the cargo holds and the WBTs and voids;
 - reinforcement of the two cross-ties at each web frame in the WBTs and voids (*see Figure 4*);

25 Polaris Shipping reported that the No. 3 P/S WBTs were essentially voids.

26 SOLAS regulation II-1/3-2 requires that double-sided skin spaces, which includes void spaces within the cargo length, on bulk carriers of 150 m or more that: a) were contracted for on or after 1 July 2008, b) the keel was laid or where the ship was at a similar stage of construction on or after 1 January 2009, or c) is delivered on or after 1 July 2012 "be coated during construction" in accordance with the performance standards in IMO Resolution MSC.215(82). Based on this regulation, the voids within the cargo length of a ship to which this regulation applies would be required to be coated. IMO Resolution MSC.215(82) also includes guidance for providing permanent means of access to facilitate inspections of coatings. The ship's flag State at the time of the conversion determined SOLAS regulation II-1/3-2 was not applicable. It is noted that in November 2008 IACS adopted a Unified Interpretation (UI) that this requirement is not applicable to single-hull tankers converted to bulk carriers when WBTs included existing structure. *See* IACS UI SC226, which became effective on 1 January 2009 and revision 1, which became effective 1 January 2014. *See also* IMO Circular MSC-MEPC.2/Circ.10.

27 Midship Section Drawing.

28 The installation of the inner bottoms and associated structure created a void space under each of the cargo holds (*see Figure 3*).

29 The hoppers and closed top side voids were not continuous through the cargo hold transverse bulkheads.

- (e) installation of swash bulkheads in the WBTs at frames Nos. 61, 70, and 79 and partial swash bulkheads at frames Nos. 67 and 72;
- (f) installation of intermediate web frames centered between each web frame in the double bottom voids; and
- (g) installation of cargo hatches and coamings.

Grade AH36 high tensile strength steel was used for the hoppers, the inner bottoms, and the longitudinal bulkhead longitudinals. Grade AH high tensile strength steel was used for the centerline member that extended from the bottom of the inner bottom to the bottom shell.

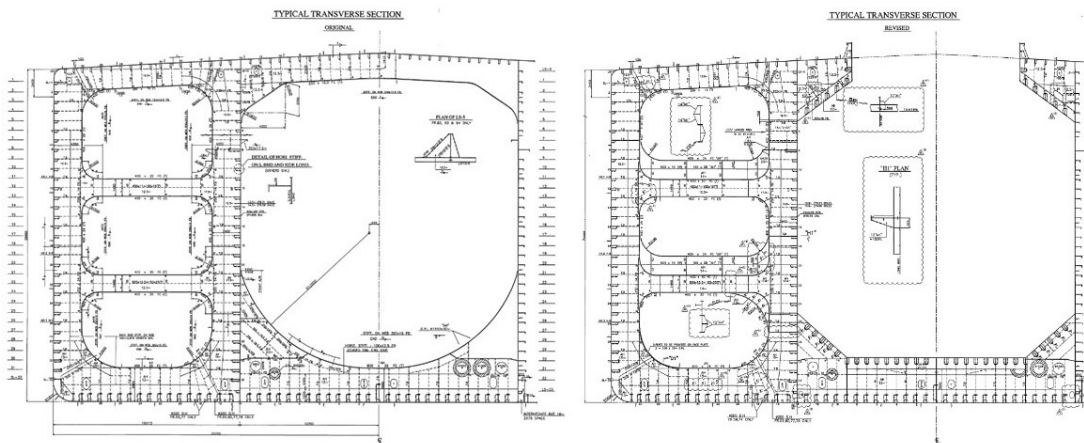

Figure 4: Typical transverse section. The original structure is on the left and the structure following the conversion is on the right.³⁰

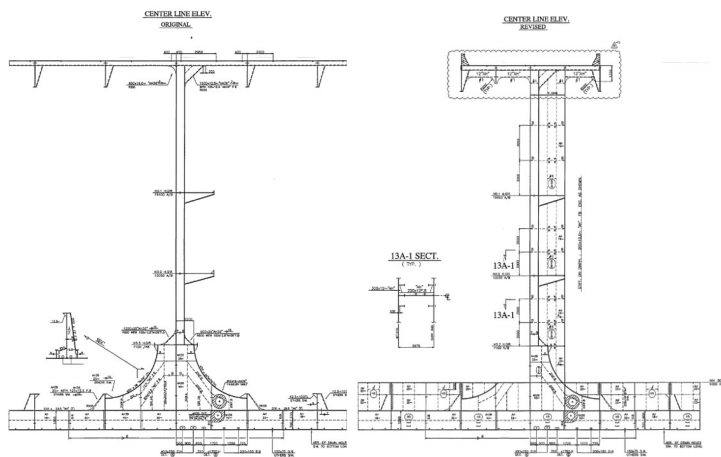

Figure 5: Detail of the cargo hold transverse bulkheads. The original structure is on the left and the structure following the conversion is on the right.³¹

30 Midship Section Drawing.

31 *Ibid.*

18. STELLAR DAISY’s ballast system consisted of a 750 mm diameter main ballast line that extended forward from the Ballast Pump Room, which was the Cargo and Ballast Pump Room before the conversion, through the centerline voids to the No. 2 C Void, and a 650 mm diameter secondary ballast line that extended from the Ballast Pump Room forward to the FPT. There were 500 mm diameter branch lines from the main ballast line and 450 mm diameter branch lines from the secondary ballast line to each of the WBTs. The valves for the main ballast line were in the centerline voids. The valves for the branch lines were in the WBTs. The main, secondary, and branch lines were made up of a combination of the existing cargo and ballast lines and new pipe (*see Figure 6*). The quantity of water in the WBTs could be monitored in the ship’s Ballast Control Room.

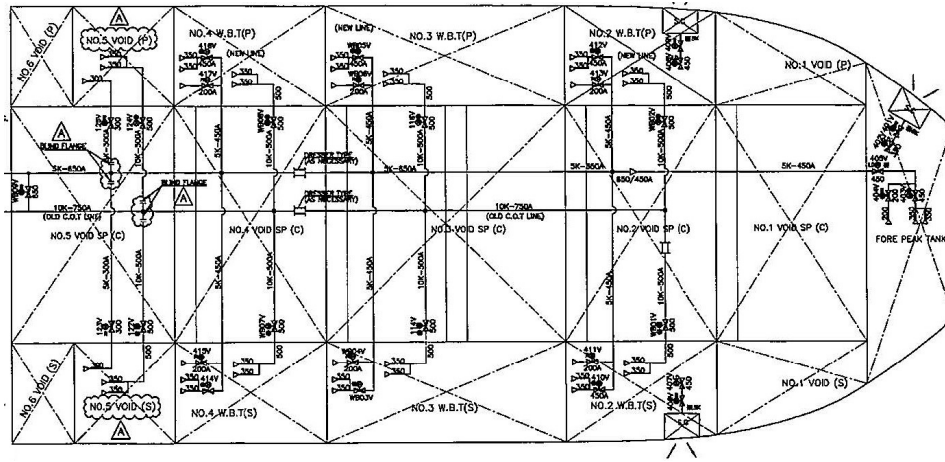

Figure 6: Portion of Water Ballast System drawing.

19. The ship was fitted with a 2,000 cubic meters per hour (m^3/hr) pump, which was cross-connected to the cargo hold bilge system, a 3,000 m^3/hr pump, and a 5,000 m^3/hr pump.³² The ship was also fitted with a 300 m^3/hr and a 1,100 m^3/hr water driven eductor.
20. The No. 2 P/S WBTs and the FPT were each fitted with a sea chest so that these tanks could be filled or emptied by gravitation (*see Figure 6*). The sea chests in No. 2 P/S WBTs were located forward of the transverse bulkhead at frame No. 75. The center of the inlet pipe was 3,275 mm above the bottom of the tank. Each of the sea chests was fitted with two, hydraulically operated, 450 mm diameter butterfly valves that were connected by a short length of pipe. The outboard valve was remotely operated from the Ballast Control Room. In an emergency, it could be operated using a hand hydraulic pump located on the main deck. The inboard valve was operated from the main deck. Both valves were designed to remain in the last ordered position upon loss of hydraulic pressure.
21. The bilge system consisted of a main line located in the centerline voids that extended from the Ballast Pump Room forward to the No. 1 Cargo Hold, and branch lines to each cargo hold and each of the void spaces in the cargo length. New pipe was used for these lines since none of these spaces required bilge piping prior to the ship being converted to a VLOC. There was a bilge well with a capacity of 4.86 m^3 on the port and starboard side at the aft end of each cargo hold. These bilge wells could be drained directly

32 The 2,000 m^3/hr pump was an existing ballast pump; the 5,000 m^3/hr pump was an existing cargo oil pump.

- to the centerline voids or emptied using a bilge pump.³³ In addition to the 2,000 m³/hr ballast pump that was cross-connected to the bilge system, the ship was fitted with a 320 m³/hr pump³⁴ for pumping the cargo hold bilges and a 150 m³/hr water driven eductor.
22. As required by SOLAS regulation XII/12, each cargo hold and the FPT were fitted with water ingress alarms that could be monitored on the Bridge and in the Ballast Control Room.³⁵
 23. When the conversion was completed on 21 January 2009, STELLAR DAISY was 266,141 DWT, which was approximately 1,976 tons more than when the ship was trading as a VLCC. The ship's lightship tonnage also increased approximately 6,000 MT and the summer draft increased 0.48 m from 19.82 m to 20.3 m.³⁶
 24. Upon completion of the conversion, STELLAR DAISY was classed by KR as an ore carrier with an Enhanced Survey Programme (ESP) notation. The ESP notation indicated the ship was subject to the requirements of the International Code on the Enhanced Programme of Inspections During Surveys of Bulk Carriers and Oil Tankers (ESP Code), IMO Assembly Resolution A.744(18).³⁷ The ESP Code was mandatory in accordance with SOLAS, Chapter XI-1, regulation 2. The ESP Code was amended and reissued in 2011.³⁸ The requirements of the ESP Code and the 2011 ESP Code were incorporated into KR's Rules for Steel Ships.
 25. Concurrent with the completion of the conversion, Polaris Shipping assumed management of STELLAR DAISY.
 26. On 22 January 2009, STELLAR DAISY was registered in the Republic of the Marshall Islands. The ship's international statutory certificates, including the ISM Certificate, were issued by KR. During the registration vetting process, it was noted that the ship had been converted from a VLCC to a VLOC. Neither a pre-registration inspection nor a review of the technical information regarding the conversion was required as part of the vetting process.³⁹
 27. Following the conversion, STELLAR DAISY began trading under a long-term continuous, or consecutive, voyage charter party⁴⁰ with Vale SA (Vale). Under the terms of the charter party, the ship was to load cargoes from Vale's terminals⁴¹ and discharge them at ports nominated by Vale.

33 The piping and valves for these drains are not included on the drawing of the bilge system, nor is it known whether they were fitted when the ship was converted to a VLOC or at a later date. It is noted that a void is commonly understood as a space or tank that is not used to hold oil, water, etc.

34 The 320 m³/hr pump had formally been the scrubber pump for the Inert Gas System.

35 It is noted that SOLAS regulation XII/12 is not applicable to WBTs or void spaces within the cargo length that are aft of the collision bulkhead.

36 ClassNK, Freeboard Assignment SUNRISE III, dated 23 August 2000.

37 The ESP Code was amended several times after being adopted. Significant amendments were adopted in 2008 (IMO Resolution MSC.261(84)). These amendments, which established separate requirements for single skin bulk carriers and double skin bulk carriers, entered into force on 1 January 2010. All references to the ESP Code will be based on those amendments. It is noted that while trading as a VLOC, the requirements of the ESP Code, Part B, were applicable to STELLAR DAISY. See ESP Code, Part B, paragraph 1.1.2.

38 International Code on the Enhanced Programme of Inspections During Surveys of Bulk Carriers and Oil Tankers—2011 (2011 ESP Code), IMO Resolution A.1049(27). The 2011 ESP Code became mandatory on 1 January 2014.

39 The Administrator's requirements that were in place when STELLAR DAISY was registered required that bulk carriers 20 or more years of age undergo a pre-registration inspection. This was changed in 2015 when the age bulk carriers were required to undergo a pre-registration inspection was reduced to 15 or more years. See Republic of the Marshall Islands Vessel Registration and Mortgage Recording Procedures (MI-100), Chapter I, Section 2.F (revision 10/15).

40 A consecutive voyage charter party may stipulate the number of voyages or the total quantity of cargo to be carried during a given period of time. The specific terms of the charter party with Vale are not known.

41 Vale operates four terminals in Brazil. Vale also operates terminals in the Argentine Republic, the Sultanate of Oman, the Republic of Indonesia, and Malaysia. The terminals outside of Brazil are used to store and transship iron ore. See <http://www.vale.com/EN/business/logistics/ports-terminals/Pages/default.aspx>.

28. On 19 June 2009, KR approved the ship's intact stability and damage stability books.⁴² The approval was based on KR's determination that STELLAR DAISY complied with the requirements of the International Convention on Load Lines, 1966 as amended by the Protocol of 1988 (ICLL 1966 as amended by the Protocol of 1988), regulation 27(8) for a reduced freeboard assignment.⁴³ Ten damage conditions were considered as part of this determination. Of the seven damage conditions based on flooding of wing tanks in the cargo length, one involved flooding of Cargo Hold No. 1, which was sufficient to comply with the damage stability requirements of SOLAS regulation XII/4 (see Figure 7).⁴⁴

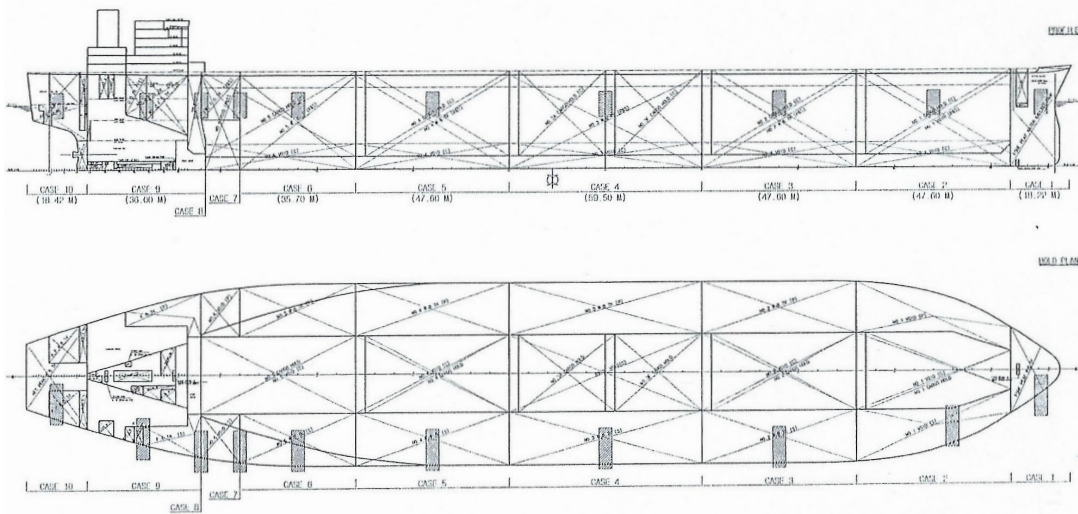

Figure 7: Damage conditions assessed to support the assignment of a reduced freeboard. The extent of the damage is shown by the grey rectangles. For the purpose of the assessment, it is assumed that the entire impacted space, or spaces, is flooded. (Source: Damage Stability Information.)

29. In May 2011, the No. 5 P/S WBTs were converted into voids. This was accomplished by isolating these spaces from the ballast system by fitting blanks in the ballast piping and by fitting each of the spaces with bilge suctions and piping.

Hull Maintenance and Repair History

Intermediate Survey / Dry Docking July 2011

30. On 28 June 2011, KR surveyors attended STELLAR DAISY at Gwangyang, Republic of Korea, which was a discharge port, to commence an intermediate survey. The surveyors remained on board

42 Mitsubishi Heavy Industries Co. Inc., DWT 265,000 Ton Class Ore Carrier (M/V "STELLAR DAISY") Final Trim, Stability and Longitudinal Strength, Drawing JD 07066-B004, dated 2009.06 (hereinafter, "Stability and Loading Manual") and Mitsubishi Heavy Industries Co. Inc., DWT 265,000 Ton Class Ore Carrier (M/V "STELLAR DAISY") Final Damage Stability Calculation, Drawing JD 08039-B004, dated 2009.06 (hereinafter, "Damage Stability Information").

43 In accordance with ICLL 1966 as amended by the Protocol of 1988, regulation 27(8), assignment of a reduced freeboard required a determination that STELLAR DAISY, when loaded to its summer load waterline and in a damaged condition as defined in paragraph (12), satisfied the damage stability criteria established in paragraph (13). Because the ship was determined to comply with the damage stability requirements of ICLL 1966 as amended by the Protocol of 1988, regulation 27, it was exempted from the stability requirements in SOLAS chapter II-1, Part B-1. See SOLAS regulation II-1/4.1.

44 The damage conditions were based on the ICLL 1966 as amended by the Protocol of 1988, regulation 27, paragraph (12). The fact that only one of these seven damaged conditions required a cargo hold be flooded was based on the only place where the longitudinal bulkhead was within B/5 or 11.5 m, whichever is less, which was in way of Cargo Hold No. 1. For that condition, it was assumed that the No. 1 S Void, Cargo Hold No. 1, and No. 1 C Void were flooded. This is consistent with the UI adopted by the IMO's MSC that SOLAS regulation XII/4.2 applies only to cargo holds with longitudinal bulkheads that are not within B/5 of 11.5 m, whichever is less, of the ship's side. See MSC/Circ.1178.

to conduct a riding survey while the ship proceeded to Zhoushan to enter the COSCO Shipyard. After STELLAR DAISY arrived at the shipyard, KR surveyors attended the ship to complete an intermediate and dry dock survey. This was the first time the ship was in dry dock following completion of the conversion in 2009.

31. Close-up surveys, or inspections,⁴⁵ were conducted in the cargo holds, all WBTs, and all void tanks⁴⁶ located within the cargo length in accordance with the applicable KR Rules for Steel Ships and the ESP Code.⁴⁷ Areas where thickness measurements were conducted included each deck plate outside the line of cargo hatch openings within the cargo length and two transverse sections, except for the wind and water strakes, within the midship half length.⁴⁸ Neither the close-up inspections nor the thickness measurements revealed any areas of concern.⁴⁹
32. While in dry dock, extensive repairs were conducted to repair cracks and replace corroded steel in the No. 2 P/S WBTs, the No. 3 P/S WBTs, the No. 4 P/S WBTs, and the No. 5 S Void.⁵⁰
 - (a) No. 2 P/S WBTs: Cracks were found in collar plates around slot holes on the No. 1 and No. 2 horizontal girders⁵¹ in way of the transverse bulkhead between the No. 2 P/S WBTs and No. 3 P/S WBTs. This bulkhead was located at frame No. 75. The cracked collar plates, which were renewed, were located approximately halfway between the transverse bulkhead and the side of the hull. The cracked vertical stiffeners in these areas were also renewed.
 - (b) No. 2 P WBT:
 - (i) The outboard portion of the web frame at frame No. 82 between Nos. 3 and 4 side shell longitudinals⁵² was found tripped and renewed. Frame No. 82 is at the forward end of this tank. The damage was located toward the top of the frame.
 - (ii) Side shell longitudinals Nos. 3 and 4 between frames Nos. 82 and 83 were tripped and fractured. The damaged areas were renewed.
 - (iii) Portions of the web transverse at frame No. 82 between side shell longitudinals Nos. 3 and 4 as well as between Nos. 7 and 8 were found corroded. The damaged area is located above the No. 1 horizontal girder. The damaged and corroded areas were renewed.

45 A close-up survey is defined as “a survey where the details of structural components are within the close visual inspection range of the surveyor, i.e., normally within reach of hand.” See 2011 ESP Code, Part B, paragraph 1.2.5. This same definition was used in the original ESP Code.

46 It is noted that although the ESP Code required that an “overall survey” of the void spaces in the cargo length, close-up inspections were conducted of both the wing tank voids and the centerline voids located below the cargo holds. See ESP Code, Annex A, Part B, paragraph 2.5.

47 The specific areas where close-up inspections were conducted are detailed in KR Reports No. YSU-S0129-11 (dated 2 July 2011) and No. NIB-S0119-11 (dated 13 July 2011). In accordance with the ESP Code, the piping in these tanks should have been inspected by the attending surveyor. See ESP Code, Annex A, paragraph 2.1.5. The survey reports do not indicate if the piping was inspected. KR informed the Administrator’s casualty investigator that on 1 July 2012, it amended its survey report form to include a requirement for surveyors to document the inspection of piping systems WBTs and voids located in the cargo length.

48 The thickness measurements are detailed in Tae Young Ind., Co. Report No. TY1110628. Thickness measurements are commonly performed by a contracted third party.

49 KR Reports No. YSU-S0129-11 and No. NIB-S0119-11.

50 *Ibid.* The repairs reported in subparagraphs a-f are documented in these survey reports. Consistent with the ESP Code and the 2011 ESP Code, KR does not require that surveyors document the grade of steel used during repairs unless the grade is different from the original. See ESP Code, Annex A, Part A, Annex 6 and Part B, Annex 6; 2011 ESP Code, Part A, Annex 6 and Part B, Annex 6.

51 There are three horizontal girders. They are numbered from top to bottom.

52 The side shell longitudinals were numbered 1-32 from the top of the tank to the bottom.

- (c) No. 2 S WBT:
- (i) Longitudinal bulkhead longitudinals⁵³ Nos. 6, 7, 9, 15, 16, 18, 20, and 23 in way of the transverse bulkhead between the No. 2 S WBT and No. 3 S WBT at frame No. 75 were corroded and renewed. These longitudinals were located between the No. 1 and No. 3 horizontal girders.
 - (ii) Brackets at the transverse bulkhead between the No. 2 S WBT and No. 3 S WBT at frame No. 75 for the No. 8 longitudinal bulkhead longitudinal and the No. 10 side shell longitudinal were corroded and renewed.
- (d) No. 3 P/S WBTs: Under deck longitudinals⁵⁴ Nos. 19 and 20 forward of frame No. 70 were found cracked and renewed. Frame No. 70 forms the forward end of the No. 3A Cargo Hold and is located between the No. 3 P/S WBTs.
- (e) No. 4 P WBT:
- (i) Vertical cracks were found toward the inboard end of the uppermost cross tie at frame No. 60 and the outboard ends of the uppermost cross ties at frames Nos. 61 and 62. Portions of the cross ties were renewed.
 - (ii) The collar plates around slot holes for vertical stiffeners⁵⁵ Nos. 18, 19, 20, 21, 26, 27, and 28 on the Nos. 1, 2, and 3 horizontal girders in way of the transverse bulkhead between the No. 4 P WBT and No. 5 P Void, which is located at frame No. 57, were found cracked. The cracked collar plates were located in the outboard half of the ballast tank. The cracked collar plates were renewed.
 - (iii) The face plate of the No. 6 and No. 8 side shell longitudinals between the transverse bulkhead between the No. 4 P WBT and No. 5 P Void at frames Nos. 57 and 58 were found corroded and renewed.
 - (iv) Longitudinal bulkhead longitudinals Nos. 6, 8, 9, 12, 13, 15, and 16 and side shell longitudinals Nos. 6, 7, 9, 10, 13, 21, 23, and 24 at the transverse bulkhead between the No. 4 P WBT and No. 5 P Void, which is located at frame No. 57, were found corroded and renewed.
 - (v) Brackets located between vertical stiffeners Nos. 19 and 20, Nos. 20 and 21, Nos. 22 and 23, Nos. 23 and 24, Nos. 26 and 27, and Nos. 27 and 28 for the transverse bulkhead between the No. 4 P WBT and No. 5 P Void at frame No. 57 were found corroded and renewed.
- (f) No. 5 S Void:
- (i) Longitudinal bulkhead longitudinals Nos. 7, 9, 10, 12, 13, 18, and 23 and the horizontal stiffeners for side shell longitudinals Nos. 6, 7, 8, 9, 14, 15, and 16 at the transverse bulkhead between the No. 4 S WBT and No. 5 S Void, which is located at frame No. 57, were found corroded and renewed.
 - (ii) Brackets located between vertical stiffeners Nos. 16 and 17, Nos. 18 and 19, and Nos. 19 and 20 for the transverse bulkhead between the No. 4 S WBT and No. 5 S Void at frame No. 57 were found corroded and renewed.

⁵³ The longitudinal bulkhead longitudinals were numbered 0-33 from the top of the tank to the bottom. Longitudinal bulkhead longitudinals Nos. 1-32 were parallel to the corresponding side shell longitudinals.

⁵⁴ The under deck longitudinals were numbered 1-32 from the centerline to the side shell. The under deck longitudinals in the P/S WBTs and P/S voids were numbered 15-32.

⁵⁵ The vertical stiffeners were numbered 1-31 from the centerline to the side shell. The vertical stiffeners in the P/S WBTs and P/S voids were numbered 16-31 and were perpendicular to the corresponding under deck longitudinal.

33. The shipyard's work done report stated that several structural members in the FPT and the APT were also renewed.⁵⁶ The shipyard's work done report did not indicate why this work was required. This work was not included in the attending KR surveyors' report.
34. The condition of the coatings was evaluated by the attending KR surveyors as follows:⁵⁷
- (a) Good: all cargo holds;
 - (b) Fair: FPT, APT, No. 2 P/S WBTs, and No. 4 P/S WBTs; and
 - (c) Poor: No. 3 P/S WBTs.⁵⁸

In accordance with KR Rules for Steel Ships, WBTs with coatings found to be in poor condition are required to be inspected every year.⁵⁹ The condition of the coating for the void tanks was not reported. Based on the attending KR surveyors' report and the shipyard's work done report, no painting was conducted in any of cargo holds, WBTs, or void spaces while STELLAR DAISY was in the shipyard.

4th Special Survey / Dry Docking June 2012

35. STELLAR DAISY entered the Zhejiang Eastern Ship Yard in Zhoushan on 14 June 2012 for dry docking and to commence the ship's 4th Special Survey in accordance with the applicable KR Rules for Steel Ships. While in dry dock, the attending KR surveyor completed a docking survey. In addition, permanent repairs were made to the ship's forepeak, which had been damaged when the ship contacted the pier while berthing in Gwangyang on 11 June 2012.⁶⁰
36. Close-up inspections were conducted in the cargo holds, all WBTs, the wing tank voids, all cargo hold hatches and hatch coamings, and the deck plate and under deck structure inside the line of hatch openings between all cargo hold hatches in accordance with the applicable KR Rules for Steel Ships.⁶¹ In addition, overall surveys were conducted of the double bottom voids located under the cargo holds.⁶² Areas where thickness measurements were conducted included each deck plate outside the line of cargo hatch openings within the cargo length, three transverse sections within the midship half length, and all plates in the full length of the wind and water strakes.⁶³ No areas of concern were reported by the attending KR surveyor based on the close-up inspections, overall surveys, or the thickness measurements.⁶⁴

56 *Ibid.* Other than the tank, the shipyard's work done report does not detail the specific location where each repair was conducted.

57 In accordance with the KR Rules for Steel Ships, Part 1, Chapter 2, paragraph 16, coatings in good condition have only minor spot rusting, coatings in fair condition have local breakdown at the edges of stiffeners and weld connections and/or light rusting over 20% or more of areas under consideration, and coatings in poor condition exhibit general breakdown over 20% or more, or hard scale over 10% or more, of the areas under consideration.

58 KR Report No. NIB-S0119-11.

59 This requirement is consistent with requirements of the ESP Code, Annex A, paragraph 2.3.1.

60 Temporary repairs had been completed to the satisfaction of the attending KR surveyor between 14–15 June 2012 and a Condition of Class was issued requiring the completion of permanent repairs no later than 22 June 2012. KR Report No. KYG-S0081-12 (dated 15 June 2012).

61 The specific areas where close-up inspections were conducted are detailed in KR Report No. NIB-S0120-12 (dated 6 July 2012) and KR Report on Compartment Survey, Work No. DLN-S007315.

62 KR Report on Compartment Survey, Report NIB-S0120-12. Although close-up inspections of the double bottom voids located under the cargo holds were conducted by the attending KR surveyor when the ship was in dry dock in July 2011, consistent with the requirements of the ESP Code that were previously noted, these tanks were not examined as part of the close-up inspections conducted when the ship was in dry dock June 2012. The survey reports do not indicate if the piping in these tanks was inspected as required by the ESP Code. As previously noted, KR informed the Administrator's casualty investigator that on 1 July 2012 it amended its survey report form to include a requirement for surveyors to document the inspection of piping systems WBTs and voids located in the cargo length.

63 The thickness measurements are detailed in Tae Young Ind., Co. Report No. TY1120616.

64 KR Report NIB-S0120-12 and KR Report on Compartment Survey, Report NIB-S0120-12.

37. Steel work that was completed while STELLAR DAISY was in dry dock included:⁶⁵
- (a) Repairs to the ship's forepeak.⁶⁶
 - (b) No. 4 P WBT:⁶⁷
 - (i) The transverse webs at frame No. 58 in way of under deck longitudinals Nos. 15-17 and Nos. 29-31, at frame No. 59 in way of under deck longitudinals Nos. 28-30, at frame No. 61 in way of under deck longitudinals Nos. 17-19, 22-28, and 31, at frame No. 62 in way of under deck longitudinals Nos. 19-26 and 28, and at frame No. 63 in way of under deck longitudinals Nos. 20-32 were corroded and partially renewed. These frames are all in the ship's midship half length. The corroded areas extended from the longitudinal bulkhead to just inboard of the side shell.
 - (ii) Under deck longitudinals No. 19 between frames Nos. 64-65 and Nos. 30-32 in way of frame No. 58 were corroded and partially renewed.
 - (c) No. 4 S WBT:⁶⁸
 - (i) The transverse webs at frame No. 58 in way of under deck longitudinals Nos. 17-28, at frame No. 59 in way of under deck longitudinals Nos. 20-27, at frame No. 63 in way of under deck longitudinals Nos. 20-27, and at frame No. 64 in way of under deck longitudinals Nos. 19-24 were partially renewed.
 - (ii) Sections of under deck longitudinals No. 19 between frames Nos. 63-65, No. 30 in way of frames Nos. 57 and Nos. 64-65, and No. 32 between frames Nos. 64-65.
38. While STELLAR DAISY was in dry dock, corroded areas in the No. 3 S WBT were water blasted and hard coated with epoxy paint.⁶⁹ Hard coating was also applied to the new steel work in the FPT and the No. 4 P/S WBTs.⁷⁰ The condition of the coatings in the cargo holds and WBTs were evaluated by the attending KR surveyor as follows:
- (a) Good: No. 3 S WBT and centerline voids;
 - (b) Fair: all cargo holds, FPT, APT, No. 2 P/S WBTs, and No. 4 P/S WBTs; and
 - (c) Poor: No. 3 P WBT.⁷¹
39. STELLAR DAISY's 4th Special Survey was completed by KR in April 2013. No additional repair work was required as part of this survey.⁷²

Dry Docking May 2015

40. In May 2015, STELLAR DAISY entered the COSCO Shipyard in Dalian, China for a scheduled dry docking. A KR surveyor attended the ship to complete an intermediate and dry dock survey.

65 Due to the poor quality of the copy of the shipyard work done report that is available to the Administrator it is not possible to determine if additional steel work was completed.

66 These repairs are detailed in KR Report NIB-S0119-12 (dated 5 July 2012).

67 These repairs are detailed in KR Report NIB-S0120-12.

68 *Ibid.*

69 *Ibid.*

70 Zhejiang Eastern Ship Yard Co., Ltd., Work Done Acceptance Paper, M/V STELLAR DAISY, Project No. ZR-12083.

71 KR Report on Compartment Survey, Work No. NIB-S0119-11.

72 KR Report Work ID No. KYGS004013.

41. Close-up inspections were conducted in the cargo holds, all WBTs, the wing tank voids, all cargo hold hatches and hatch coamings, and the deck plate and under deck structure inside the line of hatch openings between all cargo hold hatches in accordance with the applicable KR Rules for Steel Ships.⁷³ In addition, overall surveys were conducted of the double bottom voids located under the cargo holds.⁷⁴ Areas where thickness measurements were conducted included each deck plate outside the line of cargo hatch openings within the cargo length, three transverse sections within the midship half length, all plates in the full length of the wind and water strakes, and structural members subject to close-up inspections.⁷⁵ No areas of concern were reported by the attending KR surveyor based on the close-up inspections, overall surveys, or the thickness measurements.⁷⁶
42. An examination of all piping, including operational testing at working pressure, and penetrations in areas where thickness measurements were done was also completed.⁷⁷
43. The steel work that was completed while STELLAR DAISY was in dry dock included:⁷⁸
- (a) No. 2 P WBT: Fourteen sections of face plate⁷⁹ on under deck longitudinals located between frame Nos. 75 and 76 were renewed. The lengths of the renewed sections were between 400 mm and 2,500 mm.⁸⁰ The shipyard's work done report did not specify which under deck longitudinals were repaired. In addition, eight cracks that were each approximately 500 mm long on frame No. 79 were gouged and welded. The shipyard's work done report did not include where on frame No. 79 these cracks were located.
 - (b) No. 2 S WBT: A total of approximately 130 sections of side shell and under deck longitudinals throughout the length of the tank were renewed.⁸¹ The lengths of the sections that were renewed ranged from 400 mm to 5,200 mm; most were between 700 mm and 2,000 mm. The shipyard's work done report did not include which longitudinals were renewed. Multiple sections of plate, face plate, and vertical stiffeners were renewed at frame Nos. 76, 77, and 78. Six cracks that were each approximately 100 mm long on the No. 2 horizontal girder in way of frame No. 77 were gouged and welded. In addition, three collar plates also on the No. 2 horizontal girder in way of frame No. 77 were renewed.
 - (c) No. 4 P WBT: A total of 32 sections of under deck longitudinals were renewed. The lengths of the renewed sections ranged from 400 mm to 5,900 mm. Each of the under deck longitudinals in this tank required repair. The shipyard's work done report did not include the frames where the repairs were located. Twenty-seven sections of longitudinal bulkhead longitudinals between

73 The specific areas where close-up inspections were conducted are detailed in KR Condition Evaluation Report, Work ID No. DLNS007315 (verified by KR Head Office 9 June 2015).

74 KR Report on Compartment Survey, Work ID No. DLNS007315.

75 The thickness measurements are detailed in Tae Young Ind., Co. Report No. TY1150509.

76 KR Condition Evaluation Report, Work ID No. DLNS007315 and KR Report on Compartment Survey, Work No. Report on Compartment Survey, Work ID No. DLNS007315.

77 KR Condition Evaluation Report, Work ID No. DLNS007315 (verified by KR Head Office 9 June 2015).

78 The repairs reported in subparagraphs a-e are detailed in the shipyard's work done report. COSCO (Dalian), Work-Done List, Work No. D15539106B21 and COSCO Inspection Report dated 23 May 2015 for STELLAR DAISY. Although the official report completed by the attending KR surveyor (KR Survey Report, Work ID No. DLNS007315) did not document any steel work, the attending KR surveyor's notes and drawings that were used by the attending surveyor to confirm and check the completed repairs were provided by KR to the Administrator. These documents indicate that the steel work reported on the shipyard's work done report was examined and verified by the attending surveyor.

79 The under deck longitudinals were constructed of two pieces of steel plate welded together to form an "L" shape. The web was welded so that it was perpendicular to the plate forming the deck, side shell, or bottom shell. The face plate was welded so that it was perpendicular to the web.

80 Based on IACS Recommendation No. 47—Shipbuilding and Repair Quality Standard (Rev. 7, June 2013), inserts to renew internal stiffeners should be a minimum of 300 mm long, although in some circumstances inserts as short as 200 mm can be accepted. Recommendation No. 47 also includes guidance that a more stringent standard may be required for critical and highly stressed areas of the hull.

81 The attending KR surveyor's notes indicate that sections of some of the upper transverse longitudinal bulkhead longitudinals were also renewed.

600 mm and 2,000 mm in length were renewed. These were spread throughout the length of the tank. The shipyard's work done report did not specify which of these longitudinals required renewal. In addition, brackets at frames Nos. 57 and 58 were renewed.

- (d) No. 4 S WBT: Thirty-three sections of side longitudinals between 1,600 mm and 5,980 mm long between frames Nos. 57 and 58 were renewed. Some of the side longitudinals were renewed in multiple locations. The shipyard's work done report did not include where along the length of the tank these longitudinals were located. Brackets for 17 of the side longitudinals were replaced. Sections of horizontal girders Nos. 1 and 2 in way of frames Nos. 57 and 58 and two collar plates on horizontal girder No. 1 in way of these same frames were also renewed. In addition, 14 sections of longitudinal bulkhead longitudinals at various locations across the length of the tank were renewed. Although the renewed sections were between 400 mm and 7,800 mm long, most were between 2,100 mm and 5,400 mm long.
44. The condition of the coatings in the cargo holds and WBTs were evaluated by the attending KR surveyor as follows:
- (a) Good: all centerline voids;
 - (b) Fair: all cargo holds, FPT, APT, No. 2 P/S WBTs, No. 3 S WBT, and No. 4 P/S WBTs; and
 - (c) Poor: No. 3 P WBT.⁸²

Master's Internal Inspections 2016

45. In accordance with Polaris Shipping's Safety Management System (SMS), Masters are required to conduct internal inspections of cargo holds, ballast tanks, and void spaces once a quarter. If the inspection is conducted at sea while the ship is in ballast, the inspection of the WBTs is deferred until after cargo is loaded. The inspections of the port and starboard voids and WBTs are conducted by walking the bottoms and each of the horizontal girders. Although this permits a general inspection to be conducted, it is not possible to inspect most of the under deck structure since these tanks were 16.6 m wide and 29.5 m deep. These inspections are documented on a standard form, which includes a separate page to record the details for each surface in the cargo holds. Similar pages were not provided for the WBTs and voids. The inspection, which included an assessment of the condition of both the structure and paint of the cargo holds, ballast tanks, and voids, rates the condition as: excellent, good, average, fair, or poor.
46. Four inspections were conducted by STELLAR DAISY's Master in 2016.⁸³ The following observations were made during these inspections:
- (a) Cargo holds: The overall condition of the cargo holds was rated as good during each of the four inspections conducted during 2016.
 - (b) WBTs: The condition of each WBT in the cargo length and the FPT was rated as poor during each of the Master's inspections in 2016. The condition of the APT was rated as fair in March 2016 and poor in the other three inspections. During the March 2016 inspection, damage to the aft transverse bulkhead in No. 3 P/S WBTs was observed. In August 2016, it was reported that the aft bulkhead

⁸² KR Condition Evaluation Report and Report on Compartment Survey, Work ID No. DLNS007315.

⁸³ The inspections were conducted in March, May, August, and December. Each report included the name of the Master, Chief Officer (C/O), and Chief Engineer (C/E) who were on board when the inspection was completed. The Master's comments are in Korean. The Administrator had these reports translated into English. All references are to the English translation.

in No. 3 P/S WBTs had been repaired.⁸⁴ In December 2016, it was reported that the corrosion in the APT “has considerably advanced” and that the zinc anode required replacement. The condition of the coating in the No. 3 P/S WBTs was consistently observed to be bad. It was noted during each of the four inspections conducted in 2016 that “there are some places where the coating remains partially intact up to the 1st stringer, but most of it came off toward the bottom.”⁸⁵ During the inspections conducted in May, August, and December of 2016, the Master noted that the condition of the coatings in No. 2 P/S WBTs and No. 4 P/S WBTs was better than the coatings in No. 3 P/S WBTs. It was also observed that the zinc anodes in these tanks were “consumed a lot.”

- (c) Voids: The wing tank voids were rated as fair and the centerline voids were rated as poor during each of the four inspections conducted in 2016. It was observed during each of these inspections that coatings covered approximately 20% of the surfaces in each of the centerline voids. The Masters observed that the apparent cause of the observed corrosion was the practice of draining water that accumulated in the cargo hold bilges into these voids after loading.⁸⁶
 - (d) Ballast piping: During the inspections conducted in March, May, and August of 2016, the Master observed that the main ballast line was corroded, that there had not been sufficient maintenance for an extended period, and that the piping was susceptible to leaking. This comment was not included in the report for the inspection conducted in December 2016. A leak in the starboard side ballast discharge piping, which is located in the Ballast Pump Room, was observed during the August 2016 inspection. During the Administrator’s investigation, Polaris Shipping reported this was repaired by welding a patch on the pipe. In December 2016, a leak was observed in the ballast piping in way of the weld connection to the flange connection on the inlet side of the No. 2 water ballast pump. Polaris Shipping reported this leak was repaired by the crew by building up the weld.
47. Other than the repairs of the ballast piping and the transverse bulkhead at frame No. 65, which are addressed below, based on information received from Polaris Shipping, no repairs were required based on the Master’s observations in 2016 regarding the condition of the WBTs and voids.

Repairs to Transverse Bulkhead at Frame No. 65 August 2016

48. During the Master’s inspection conducted in March 2016, it was observed that the transverse bulkhead between the No. 3 P/S WBTs and the No. 4 P/S WBTs at frame No. 65 was distorted.⁸⁷ The distorted section of the transverse bulkhead in these four tanks extended from the just above the bottom shell to the No. 3 horizontal girder and spanned nearly the entire breadth of the tanks. In addition, 14 of the 16 vertical stiffeners, which were located on the forward side of the frame, in this same area, were tripped. Based on available records and information provided when Polaris Shipping’s Designated Person Ashore (DPA) and the ship’s Superintendent were interviewed as part of the Administrator’s investigation, there is no indication the damage was reported by the Master or ship management to KR.
49. The ship’s Superintendent attended STELLAR DAISY during cargo discharge in Lumut, Malaysia in May 2016 to inspect the transverse bulkhead at frame No. 65. During this attendance, the Superintendent determined the distorted portion of the bulkhead extended from just above the bottom longitudinals to approximately 1 m above the No. 3 horizontal girder on both the port and starboard sides. He also

⁸⁴ This damage and repairs are discussed in detail in the next section of this Report.

⁸⁵ It is not known if the 1st stringer referred to the No. 1 horizontal girder or the No. 3 horizontal girder.

⁸⁶ In accordance with Vale’s regulations for the Ilha Guaiba Terminal, cargo bilge wells are not permitted to be drained while a ship is alongside (*see* Vale SA, “Regulation of the Terminal of Ilha Guaiba,” Art. 39 (not dated)). Similar regulations are in place at other Vale terminals in Brazil.

⁸⁷ There was no distortion of this bulkhead in way of Cargo Hold No. 4 or the void space between Cargo Hold No. 3 and Cargo Hold No. 4.

determined that the repairs would have to be conducted in a shipyard. When interviewed as part of the Administrator's marine safety investigation, the Superintendent who attended STELLAR DAISY in Lumut stated "[he] examined the bulkhead between the No. 2 P/S WBTs and No. 3 P/S WBTs and did not observe any similar damage."

50. Based on available records and information provided when Polaris Shipping's DPA and the ship's Superintendent were interviewed as part of the Administrator's investigation, it could not be verified that the damage was reported to KR following the Superintendent's attendance. Polaris Shipping determined the damage was not sufficient to place any restrictions on the quantity of cargo that could be loaded or on the ship's routing prior to the completion of repairs. Upon completion of cargo discharge, STELLAR DAISY departed from Lumut in ballast for Ilha Guaíba to load cargo.
51. While the remainder of the cargo loaded in Ilha Guaíba was discharged in Rizhao, China,⁸⁸ KR surveyors attended STELLAR DAISY to conduct an annual class survey from 11–12 August 2016. During the annual survey, the attending surveyors issued a recommendation that the deformed vertical stiffeners at frame No. 65 in No. 3 P/S WBTs be examined and repaired during the ship's next port call but no later than 11 September 2016.⁸⁹ Following completion of cargo discharge on 13 August 2016, STELLAR DAISY proceeded to the Zesco Shipyard in Zhoushan. The ship entered the ship yard on 15 August 2016.
52. According to the Master's Statement of Fact referenced in the report of the KR surveyor who attended STELLAR DAISY in Zesco Shipyard in August 2016, the transverse bulkhead at frame No. 65 was damaged while the ship was underway on a laden voyage in heavy weather.⁹⁰ During an 18-hour period on 20–21 February 2016, the ship reportedly encountered Beaufort Force 7-8 winds, was shipping seas on deck, and was working heavily while transiting the East China Sea en route to Lianyungang, China. The ship's speed during this period was approximately 11-12 knots.⁹¹
53. Prior to the start of repair work, a KR surveyor conducted a damage survey as required by KR Rules for Steel Ships.⁹² The attending KR surveyor observed that on the port side the damage was between the No. 2 horizontal girder and the bottom shell, and on the starboard side from approximately halfway between the No. 2 and No. 3 horizontal girders and the bottom shell (*see Figure 8*). He also observed that the plate forming the transverse bulkhead showed convex deformation across the breadth of the No. 3 P/S WBTs and the No. 4 P/S WBTs toward the stiffener side and that the vertical stiffeners were tripped. The attending KR surveyor stated he did not observe any damage when he examined the transverse bulkhead at frame No. 57 between No. 4 P/S WBTs and No. 5 P/S Voids nor did he observe any damage to the transverse bulkhead at frame No. 75 between No. 2 P/S WBT and No. 3 P/S WBTs when he examined it from the No. 3 P/S WBTs. He also stated that he was not able to examine this transverse bulkhead from the No. 2

88 STELLAR DAISY discharged 159,084 MT of iron ore at Lianyungang from 5–8 August 2016 and 99,243 MT at Rizhao.

89 KR Report No. QDOS010716 (dated 12 August 2016).

90 KR Report No. NIBS020816. The Master's Statement of Fact was dated 16 August 2016.

91 The ship's speed is based on the Long-Range Identification and Tracking (LRIT) data transmitted by STELLAR DAISY on 20-21 February 2016.

92 KR Rules for Steel Ships, Part 2, Chapter 3, Section 1.

P/S WBTs because they contained ballast water, but that he was informed by the Master, C/O, and ship's Superintendent that they had examined this transverse bulkhead before STELLAR DAISY entered the shipyard and had not observed any damage.⁹³

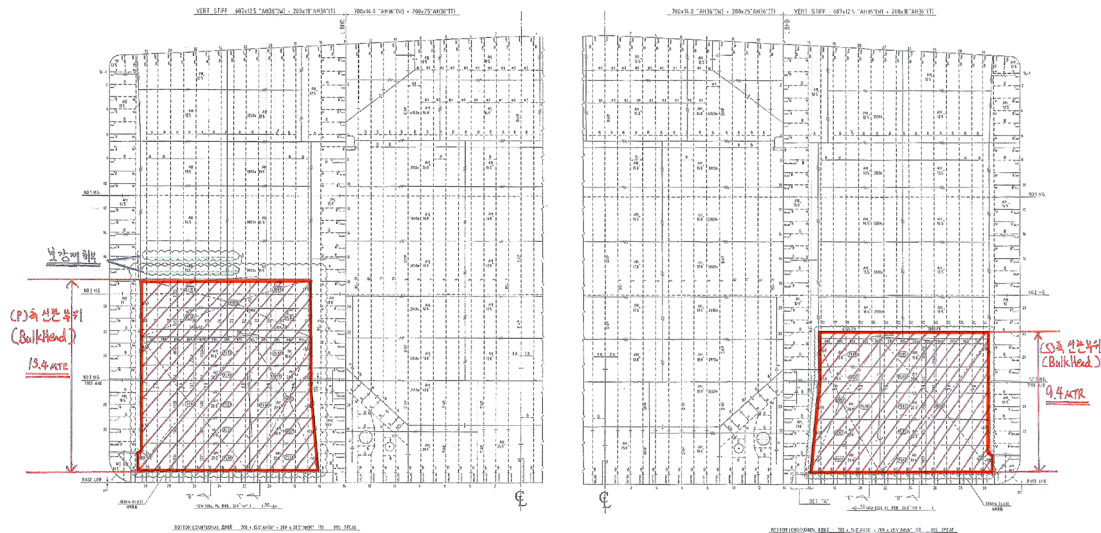

Figure 8: Transverse bulkhead at frame No. 65 starboard (left) and port (right). The side shown is the No. 3 P/S WBTs. The hatch marks denote the damaged area.

54. Based on the findings of the damage survey conducted by the KR surveyor who attended STELLAR DAISY at the Zesco Shipyard in August 2016 and the Master's Statement of Facts, KR conducted a failure analysis to determine the cause of the observed damage of the transverse bulkhead at frame No. 65.⁹⁴ During the Administrator's marine safety investigation in the loss of STELLAR DAISY, KR informed the Administrator it determined the damage of the transverse bulkhead at frame No. 65 was caused by the force of buoyance pushing against the bottom shell as the ship worked in the seas and that the damage should be renewed to original scantlings.⁹⁵ KR also informed the Administrator it considered the damage of the transverse bulkhead at frame No. 65 to be isolated.
55. The repairs documented by the attending KR surveyor on the port side included renewing the:⁹⁶
 - (a) bulkhead plate for an area that extended vertically from above the bottom longitudinals to 2,200 mm above the No. 2 horizontal girder and spanned 14 of the 17 bottom longitudinals from a point approximately 2,500 mm inboard of the side shell to a point approximately 2,500 mm outboard of the longitudinal bulkhead;

⁹³ The damage that the attending KR surveyor reported observing when he conducted the damage survey of STELLAR DAISY after the ship entered the Zesco Shipyard is based on the Surveyor's Statement of Fact (dated 7 August 2016). The observed damage is consistent with what was reported by the ship's Superintendent when he attended the ship in Lumut in May 2016. It is also consistent with the repairs that were completed while STELLAR DAISY was in the Zesco Shipyard in August 2016. See KR Report No. NIBS020816 (dated 25 August 2016).

⁹⁴ During the Administrator's investigation, KR informed the Administrator that in accordance with KR's procedures for damage surveys, the findings of the damage survey were communicated to the Survey Team and were reviewed by the Plan Review Team at KR's office in Busan, Republic of Korea.

⁹⁵ The hull was subject to transverse sagging when in a laden condition.

⁹⁶ KR Report No. NIBS020816 (dated 25 August 2016).

- (b) fourteen tripped vertical stiffeners from the top of the bottom longitudinals to 270 mm above the No. 2 horizontal girder and the corresponding brackets in way of the bottom longitudinals;
- (c) No. 3 horizontal girder in way of the renewed bulkhead plate; and
- (d) portions of the No. 2 horizontal girder.

The repairs on the starboard side that were documented by the attending KR surveyor were similar except they extended 270 mm above the No. 2 horizontal girder.⁹⁷ The repairs were conducted afloat with the ship in a light ship condition.

56. In addition to the repairs that were documented on the survey report, the attending KR surveyor required that horizontal stiffeners, or intercostals, be fitted between each of the vertical stiffeners halfway between the No. 2 and No. 3 horizontal girders.⁹⁸ The intercostals on the port side consisted of 300 x 14 mm flat bar. The intercostals on the starboard side consisted of a 600 x 14 mm web with a 200 x 14 mm snipped flange.⁹⁹ Based on KR's determination that the damage to the transverse bulkhead at frame No. 65 was isolated, KR did not require that intercostals be fitted between the vertical stiffeners for the transverse bulkheads at frame Nos. 57 and 75.
57. Based on available records, KR did not inform the Administrator of the damage to frame No. 65.¹⁰⁰

Flag State Safety Inspections

58. After being registered in the Republic of the Marshall Islands, an initial safety inspection was conducted in April 2009 to verify compliance with applicable Republic of the Marshall Islands and international safety, security, and environmental protection requirements. Flag State safety inspections were then conducted each subsequent year.
59. In accordance with the Republic of the Marshall Islands law and international conventions, the annual safety inspections included, among other things: safety and navigation systems; the condition of weather and watertight closures; pollution prevention equipment; and crew performance during fire and abandon ship drills. They also included a visual assessment of the external portions of the ship's hull and deck.¹⁰¹ These inspections typically do not include internal examinations of WBTs, voids, or cargo holds or a review of Classification Society survey records. Special inspections are conducted, when warranted, to assess conditions not covered by an annual safety inspection, such as internal structural condition.
60. One deficiency and two observations were issued during the flag State inspection conducted in September 2012: one observation was for the Articles of Agreement not being completed; one observation was

⁹⁷ *Ibid.*

⁹⁸ These intercostals are shown on a drawing prepared by Zesco Shipyard to document the repairs that were completed. Zesco Shipyard, STELLAR DAISY Repair of Fr.65 W.T.BHD., Drawing No. ZESCO/R16118-10-12.

⁹⁹ According to KR, the design of the intercostals fitted on the port side was per the instructions from the attending KR surveyor. It is not known who determined the design of the intercostals that were fitted on the starboard side. They were approved by the attending KR surveyor.

¹⁰⁰ Notification was required by the 2016 Agreement between the Republic of the Marshall Islands Maritime Administrator and KR to Govern the Delegation of Statutory Certification and Services for Vessels Registered in the Republic of the Marshall Islands (2016 RO Agreement), Annex II, section 8. Upon receipt of a report of structural damage from a Recognized Organization (RO), the Administrator would review the information provided and determine if any additional information or action, such as a risk assessment, restrictions on the ship's operations, identification of the cause of the damage, and/or planned repairs was required. Actions that the Administrator might take include, approving the issuance of a short-term Safety Construction Certificate with or without imposing any restrictions beyond those being imposed by the RO and further follow-up with the RO.

¹⁰¹ The scope of flag State annual safety inspections are based on the Republic of the Marshall Islands law and regulations and is documented using the Report of Operational Safety Inspection (Form MI-252).

for an emergency light in the Accommodations and a deck light on the fore mast not working; and one deficiency was for a slightly leaking fire hose. No deficiencies were issued during the flag State inspections conducted between 2013–2016.¹⁰²

Port State Control Inspections

61. STELLAR DAISY was also subject to port State control (PSC) inspections in accordance with guidelines established by the IMO and national requirements established by the port States where the ship called.¹⁰³ The scope of these inspections is similar to the scope of the annual flag State safety inspections. The last PSC inspection conducted on board STELLAR DAISY was in Tianjin, China on 7 February 2017. During this inspection, two deficiencies related to watertight integrity were issued. Both, which were based on the observed condition of weather tight doors located on the upper decks of the ship's accommodations, were corrected by the ship's crew on 8 February 2017. During the four PSC inspections prior to the 7 February 2017 inspection, no deficiencies were issued related to the ship's structure or watertight integrity.¹⁰⁴ Further, none of the deficiencies that were issued during any of the last five PSC inspections resulted in STELLAR DAISY being detained by a port State.
62. Brazil's national requirements for foreign ships operating in Brazilian waters include requirements for condition surveys of bulk carriers that load cargoes with a density equal to or greater than 1.78 MT/m³.¹⁰⁵ These surveys, which are generally valid for one year, are conducted by a Classification Society, other than the ship's Classification Society, that is authorized to act on behalf of Brazil. These surveys include: an internal inspection of the ship's cargo holds, ballast tanks, double bottoms, wing tanks, and FPT; random thickness measurement of the structure; and a visual inspection of the hatch covers, including cleats and gaskets.¹⁰⁶
63. STELLAR DAISY was the subject of five condition surveys per the Brazilian requirements between 2013 and 2016, which included internal inspections of each cargo hold and the FPT. All five condition surveys were conducted while the ship was at anchor and the No. 2 P/S WBTs and No. 4 P/S WBTs were filled with ballast, which prevented them from being inspected. In addition, none of the centerline voids located under the cargo holds were inspected during any of these surveys. The No. 1 P/S Voids were inspected on 3 October 2016, the No. 3 P/S WBTs were inspected during each of these five condition surveys, No. 5 P/S Voids were inspected during all but the last condition survey and the one conducted in 2013, and the No. 6 P/S Voids were inspected 17 August 2013. No repairs were recommended based on the results of each of these surveys and STELLAR DAISY was authorized to load cargo in Brazilian ports.¹⁰⁷

102 The last flag State inspection was conducted while STELLAR DAISY was discharging cargo in Lumut in November 2016.

103 Port States that are a member of a PSC Memorandum of Understanding (MoU) would generally incorporate policies established by the PSC MoU into their inspection regime.

104 Based on information reported by the Tokyo MoU PSC database, one deficiency relating to the ship's structural condition was issued during a PSC inspection conducted in Pohang, Republic of Korea on 10 October 2013. Based on the PSC inspection report, the one deficiency issued during this inspection was for an indicator for an inoperative solenoid valve located in the FPT. The Tokyo MoU PSC database also reported that one deficiency related to watertight integrity was issued during the PSC inspection conducted in Zhoushan on 13 July 2011. Based on the PSC inspection report issued during the inspection, this deficiency was for the scupper in the air-conditioner room being blocked.

105 See Brazilian Navy Directorate of Ports and Coasts, Maritime Authority Standards for the Operation of Foreign-Flagged Vessels in Brazilian Jurisdictional Waters (NORMAN-04/DPC), Rev. 1 (2013), Chapter 3.

106 *Ibid.*, section 0306.

107 See the Statement of Condition Survey issued for condition surveys conducted on 3 October 2016, 7 January 2016, 18 March 2015, 9 June 2014, and 17 August 2013.

Ship Crew

64. The Minimum Safe Manning Certificate (MSMC) issued by the Administrator required STELLAR DAISY to have a minimum crew of 16.¹⁰⁸
65. STELLAR DAISY departed from Portuário da Ilha Guaíba, Brazil on 26 March 2017 with a crew of nine officers and 15 ratings. No crew changes had occurred during the ship's port call, nor were any crew signed off. Eight of the officers, including the Master, C/O, and C/E were Korean, and one of the two Third Engineers on board was Filipino. The ratings were all Filipino. All the officers and ratings except for two of the three ABs held the appropriate documents issued by the Administrator for their position on board.¹⁰⁹
66. As of 31 March 2017, the ship's Master had just under 27 years of service at sea on different types of ships. He had sailed as Master since 2006, almost exclusively on purpose built bulk carriers, the largest of which was 180,000 DWT. He was first hired by Polaris Shipping in February 2017 and joined STELLAR DAISY on 21 February 2017. Based on the Administrator's interview of Polaris Shipping's DPA, before signing on STELLAR DAISY, the Master received a briefing in Polaris Shipping's offices that included a multiple day review of the SMS. The requirement to conduct quarterly structural inspections was discussed. It was reported that no specific issues with the ship's structure were raised. During this time, the International Maritime Solid Bulk Cargoes (IMSBC) Code¹¹⁰ requirements for loading and transporting cargoes commonly transported by ships in Polaris Shipping's managed fleet were also reviewed.
67. The C/O who was on board on 31 March 2017 had 17 years of sea service, almost all of which was on bulk carriers. He first sailed as C/O in 2008, which included a contract on a 300,000 DWT bulker. He was employed by Polaris Shipping in November 2016 and signed on STELLAR DAISY on 11 November 2016.
68. The C/E who was on board on 31 March 2017 had 22 years of service at sea on different types of ships. He had sailed as C/E since 2011 on container ships and bulkers. He was first hired by Polaris Shipping in November 2016 and joined STELLAR DAISY on 11 November 2016.

Cargo Loading

69. STELLAR DAISY arrived at the Sepetiba Bay outer anchorage in ballast on the morning of 22 March 2017 and tendered a notice of readiness. That evening, the ship shifted to the inner anchorage. Sometime prior to berthing, the No. 3 P/S WBTs were each filled with 26,000 MT of ballast water so the ship's air

108 The MSMC issued by the Administrator on 26 January 2016 required STELLAR DAISY to carry a Master, C/O, two Officers in Charge of Navigational Watch, three Able-Bodied Seafarers (ABs) or Able Seafarers-Deck (AS-Ds), two Ordinary Seafarers (OSs), a C/E, a First Assistant Engineer, two Officers in Charge of Engineering Watch, and three Oiler/Motormen or Able Seafarers-Engine (AS-Es). As of 1 January 2017, in accordance with the International Convention on Standards of Training, Certification and Watchkeeping for Seafarers, 1978 (STCW Convention) as amended by the 2010 STCW Conference (2010 Manila Amendments), the ship was required to carry three AS-Ds. To remain consistent with the ship's Crew List, AB rather than AS-D and Oiler or Motorman rather than AS-E will be used from here forward when referring to the crewmembers who were on board upon departure from Portuário da Ilha Guaíba on 26 March 2017.

109 The Bosun and the two ABs held Certificates issued by the Republic of the Philippines qualifying them to serve as AS-Ds in accordance with the STCW Convention as amended by the 2010 Manila Amendments. An application was submitted to the Administrator on behalf of the Bosun for qualification as an AS-D on 6 February 2017. This application was rejected based on him being determined to be color blind during a medical exam conducted on 7 November 2016. Although he was qualified to serve on board STELLAR DAISY as a Bosun, he could not serve as an AS-D or OS. The Administrator does not have a record of receiving applications for these two ABs to receive the documents meeting the requirements of the 2010 Manila Amendments for service as an AS-D. However, both held a special qualification issued by the Administrator in accordance with the requirements that were in place prior to 1 January 2012 for service as an AB. It is noted that the Bosun signed on STELLAR DAISY in November 2016 and the two ABs signed on in September 2016.

110 IMO Resolution MSC.268(85), as amended.

- draft in way of the cargo length was less than 19 m.¹¹¹ At 0150¹¹² on 23 March 2017, STELLAR DAISY was moored at the Ilha Guaíba Terminal's south berth.
70. Vale's Ilha Guaíba Terminal is located on Guaíba Island, which is connected to the mainland by rail bridge; there is no access by road. Iron ore is transported to the island by rail, where it is stockpiled prior to loading. The terminal has a single jetty with a rail mounted, single chute loader that has a maximum loading rate of 13,800 metric tons per hour (MT/hr). The loader's average rate is 8,000 to 9,000 MT/hr. Iron ore is distributed throughout the hold by moving the location of the chute in order to minimize the potential for overstressing the tank top during cargo loading. At the end of the pour, the loading chute is moved from side to side within the hatch opening to limit the difference between any peaks and troughs that might exist from the loading process.
71. After STELLAR DAISY was moored, the C/O and terminal representative reviewed the plan for loading 260,000 MT of iron ore fines with a density of 2,646 kg/m³.¹¹³ The loading plan required 22 pours with a planned loading rate of 8,500 MT/hr and a deballasting rate of 7,000 MT/hr.¹¹⁴ The planned time to load STELLAR DAISY was 30 hours. Based on the loading plan, two pours were to be made at each hatch with two final pours at hatches No. 2 and No. 9 for trimming. The loading sequence was established to maintain bending moments and shear forces within in-port values during loading and at-sea values when loading was completed.
72. Iron ore fines is an IMSBC Code Group A cargo.¹¹⁵ Group A cargoes are those which may liquefy if shipped at a moisture content (MC) greater than their transportable moisture limit (TML).¹¹⁶ Vale also provided the C/O with copies of the cargo information and certificates of testing required by the IMSBC Code, Section 4.¹¹⁷ Based on the certificates of testing, the TML of the cargo to be loaded was 11.44%. The TML was assessed in Vale's laboratory at the Ilha Guaíba Terminal¹¹⁸ on 28 September 2016 and the results were valid until 27 March 2017. The MC, as determined in the terminal's lab on 22 March 2017, was 9.23%.

111 When underway in ballast, the FPT, No. 2 P/S WBTs, No. 4 P/S WBTs, and APT were filled. The No. 3 P/S WBTs were filled with ballast water to control the air draft in way of the cargo length during cargo loading and discharge.

112 As STELLAR DAISY proceeded eastward toward the Cape of Good Hope, South Africa, the ship's clocks were adjusted. Unless indicated otherwise, all times from this point onward are the ship's local time (UTC -3).

113 Copies of the agreed loading plan and cargo information provided by Vale to STELLAR DAISY bearing the C/O's initials and stamp were provided to the Administrator by Vale. Based on the cargo information provided by Vale, the trade name for the cargo was Sinter Feed High Silica Guaíba (SFHG). Vale reported that the cargo loaded on STELLAR DAISY consisted of natural, non-concentrated iron ore containing both 10% or more of fine particles less than 1 mm and 50% or more of particles less than 10 mm and which is not enriched and does not undergo any mineral concentration processes. SFHG is a trade name of long standing usage which is intended to reflect the intended use of the cargo as opposed to its characteristics.

114 Based on the information available to the Administrator, it is not known if during cargo loading ballast water was discharged from No. 2 P/S WBTs by gravitation using the sea chests in these tanks. It would potentially have been possible to use gravitation until the ship's draft was equal to the depth of water in the tank, which based on the loading plan would likely have occurred during pour eight. Based on the loading plan, there would have been approximately 18.8 m of ballast water in the No. 2 P WBT at the start of pour eight and approximately 10.7 m of ballast water remaining when the pour was completed. The ship's drafts were predicted to be 11.66 m forward, 12.9 m midship, and 14.13 m aft at the start of the pour and 12 m forward, 13.15 m midship, and 14.3 m aft on completion of the pour. If gravitation had been used, at least one of the butterfly valves would have needed to be closed by the time the ship's draft exceeded the depth of water in the tank to prevent the ingress of sea water.

115 IMSBC Code, as amended by IMSBC Amendment 03-15, (IMO Resolution MSC.393(95)), which entered into force on 1 January 2017. See also IMO Circular DSC.1/Circ.71, "Early Implementation of Draft Amendments to the IMSBC Code Related to the Carriage and Testing of Iron Ore Fines," Annex 1.

116 IMSBC Code, Section 1, Sub-section 1.7.

117 Copies of these documents with the C/O's initials and ship's stamp were provided to the Administrator by Vale.

118 The laboratory at the Ilha Guaíba Terminal is certified by Brazilian Navy Directorate of Ports and Coasts, which is the competent authority at the port of loading to conduct TML and MC tests as required by the IMSBC Code, Section 4 and IMO Circular MSC.1/Circ.1454/Rev.1. Certificates provided by Vale show the Laboratory Test Procedures used were in accordance with ISO 3082/2011 "Iron Ores—Sampling and Sample Preparation Procedures" and ISO 3087/2011 "Iron Ores—Determination of the moisture content of a lot."

73. Members of a ship's crew may disembark at the pier at the Ilha Guaíba Terminal only when necessary to perform tasks such as checking the ship's drafts.¹¹⁹ Based on information provided by the DPA, when interviewed as part of the Administrator's investigation, access to the cargo stockpiles is not permitted.
74. On 23 March 2017, in preparation for loading, the C/O and a Vale representative inspected the cargo holds and determined they were free of water.¹²⁰ In addition, the cargo wells were likely fitted with a micro filtration system to prevent clogging of the bilge system by cargo particles.¹²¹
75. Cargo loading began at 0825 on 23 March 2017 and was completed at 2124 on 25 March 2017.¹²² The total amount of cargo loaded was 260,003 MT of iron ore fines. The total time from when the cargo loading commenced to when it was completed was 60.6 hours. Considering that loading was stopped for a total of 34.16 hours,¹²³ the actual time loading was 26.44 hours, which was just under four hours less than the planned loading time. Based on the actual loading time, the average loading rate was 9,833.7 MT/hr.
76. Statements from STELLAR DAISY's surviving crew members, Polaris Shipping's DPA, and a Vale port captain all indicate that it did not rain at the Ilha Guaíba Terminal from the time the MC of the cargo was assessed on 22 March 2017 through the time cargo loading was completed and the cargo hold hatches closed on 25 March 2017. This is consistent with weather observations recorded at the airport in Santa Cruz, which is approximately 30 kilometers to the east northeast of Ilha Guaíba Terminal.¹²⁴ Other than approximately 0.05 centimeters (cm) of rain that was recorded at 0500 on 22 March 2017, no other precipitation was reported until 28 March 2018.
77. Polaris Shipping's DPA stated, when interviewed as part of the Administrator's investigation, that he had not received any messages or telephone calls from STELLAR DAISY's Master reporting any concerns with the cargo being loaded or the cargo loading operation. Further, the surviving crew members reported they were not aware of any problems that occurred during cargo loading.
78. Records of the actual bending moments and shear forces on the ship's hull during and upon completion of loading are not available. Based on the loading plan, the maximum bending moment occurred during pour eight when it was 67% of the allowed in-port value, and the maximum shear force occurred during pour 19 when it was 82% of the allowed in-port value. According to the loading plan, on completion of loading the maximum bending moment was 55% of the allowed at-sea value and the shear force was 85% of the allowed at-sea value. Based on calculations performed by Polaris Shipping after STELLAR DAISY was reported lost, after loading the maximum bending moment was 53% of the allowed at-sea

119 See Vale's Quick Safety & Port Operational Guidelines and Guaíba Island Terminal Safety Rules. Copies of these documents were provided to STELLAR DAISY's C/O.

120 The Vale Before Loading Certificate, which was signed by the C/O and a Vale terminal representative.

121 Based on available information, it could not be confirmed that STELLAR DAISY's cargo bilge wells were fitted with a micro filtration system. However, it is considered likely that they were since Vale's terminal regulations require that such a system be fitted prior to loading and the shipping information included a recommendation to fit the cargo hold bilge wells with a filtration system. Vale SA, Regulation of the Terminal of Ilha Guaíba, Arts. 40-44 (not dated). In addition, Polaris Shipping's DPA and one of STELLAR DAISY's prior Masters stated, when interviewed as part of the Administrator's investigation, that the bilge wells were fitted with a filtration system before loading iron ore fines at the Ilha Guaíba Terminal on other occasions.

122 These times are based on the terminal's Statement of Facts for the cargo loading operation. A copy of this Statement of Facts was reviewed and agreed to by STELLAR DAISY's Master prior to the ship's departure. A copy with the Master's initials and stamp was provided to the Administrator by Vale.

123 Based on the terminal's Statement of Facts for the cargo loading operation, all stoppages during cargo loading were on the terminal's account and were not related to STELLAR DAISY.

124 The weather station at the Santa Cruz airport is operated by the Brazilian Air Force. A copy of the weather recorded at the Santa Cruz airport is on file with the Administrator.

value and the maximum shear force was 77% of the maximum allowed at-sea value.¹²⁵ The maximum bending moment was located at frame No. 55, which is toward the forward end of No. 5 Cargo Hold, and the maximum shear force was located at frame No. 49.5, which is at the aft end of this cargo hold.

Voyage 041

79. STELLAR DAISY got underway from the Ilha Guaíba Terminal at 0030 on 26 March 2017 for Qingdao which was the nominated discharge port. STELLAR DAISY's estimated date of arrival was 5 May 2017. The ship's drafts on departure were 20.2 m fore, midships, and aft. Upon departure, there were no known problems reported to Polaris Shipping with STELLAR DAISY's equipment. After disembarking the pilot, STELLAR DAISY proceeded on a southeasterly course toward the Cape of Good Hope, South Africa at approximately 12 knots, which was the charter party speed established by Polaris Shipping and Vale.
80. In accordance with the IMO Code on Intact Stability for All Types of Ships Covered by IMO Instruments (IS Code) (IMO Resolution A.749(18)), the ship was required to have a minimum initial metacentric height (GM_0)¹²⁶ of 0.15 m and a maximum righting lever (GZ_{max})¹²⁷ of at least 0.2 m at an angle of heel equal to or greater than 30°. Based on stability calculations performed by Polaris Shipping after STELLAR DAISY was reported lost, the ship's GM_0 was 10.215 m.¹²⁸ The ship's calculated GZ_{max} was 5.628 m, which occurred at an angle of heel of 43.338°. The calculated values of GM_0 and GZ_{max} are consistent with the Administrator's calculations and those in the ship's Stability and Loading Manual for departure with a high-density cargo. As shown in *Table 3*, the ship's reserve stability also exceeded the requirements established by the IMO.¹²⁹

Area Under Righting Lever Curve (meter-radians)	Required	Calculated
Area to 30°	0.055	1.393
Area to 40°	0.09	2.316
Area Between 30° and 40°	0.03	0.923

81. Based on available satellite Automatic Identification System (AIS) data, no information was received from STELLAR DAISY's AIS after 0421 UTC on 26 March 2017. Polaris Shipping's DPA was not aware of any reason that the ship's AIS may have stopped transmitting. It is noted that information from the ship's AIS was received continuously from 1 January 2017 until 0421 UTC on 26 March 2017.¹³⁰

125 The values calculated by Polaris Shipping are consistent with values that were independently calculated by KR.

126 IS Code, paragraph 3.1.2.4. Metacentric height (GM) is the distance of a ship's metacenter (M) from the vertical center of gravity (KG). The initial location of M is on the ship's centerline above the keel at the intersection through which the buoyant force of the ship's hull for small angles of heel acts. Whereas the location of M is a function of the ship's hull, the location of KG is a function of how the ship is loaded and other factors, such as how much fuel oil or ballast is on board. The GM will change over the course of the voyage as the location of KG changes due to changes in the ship's loading condition. For any given loaded draft, STELLAR DAISY's GM_0 would have been larger when loaded with high-density cargoes than with low-density cargoes. A ship with a large GM_0 is said to be stiff and is subject to larger shear forces when rolling than a ship with a smaller GM_0 .

127 IS Code, paragraph 3.1.2.2. The righting arm is the distance between the line through which the force of gravity and the force of the hull's buoyancy work. The magnitude of this arm and the angle of heel at which GZ_{max} occurs is a function of how the ship is loaded and the ship's hull.

128 It is noted that the ship's GM_0 in ballast was typically between 15.615-17.101 m. Stability and Loading Manual, p. 62.

129 IS Code, section 3.1.2.

130 This period included laden and ballast voyages.

82. While underway, STELLAR DAISY received regular weather reports and routing information from StormGeo.¹³¹ The first report from StormGeo received after the ship got underway was transmitted at 1027 UTC on 26 March 2017. The forecast weather is shown in *Table 4*. The routing was based on keeping the ship to the north of higher swells to the south.

Table 4: Forecast Weather Received 26 March 2017

Forecast (date/time)	Winds		Waves	Swells			Significant Waves	
	Dir	Beaufort Force	Height (m)	Dir	Height (m)	Period (seconds)	Dir	Height (m)
27/0000Z	SSW	4	1.0	SE	1.5	11	SE	1.5
27/1200Z	W	5	2.0	SE	1.0	10	W	2.0
28/0000Z	NW	3	0.5	NW	1.5	5	NW	1.5
28/1200Z	SSE	6	2.5	NNE	1.5	8	SSE	3.0
29/0000Z	SE	7	3.0	SSE	2.5	9	SE	4.0
29/1200Z	SE	7	3.0	S	3.0	10	SE	4.0
30/0000Z	SE	7	3.5	SSE	4.0	9	SSE	5.0
30/1200Z	SE	7	3.0	ESE	3.5	9	ESE	5.0
31/0000Z	E	7	3.0	ESE	3.5	9	ESE	4.5

83. Based on STELLAR DAISY's Noon Reports, the ship's speed was approximately 12 knots from noon on 26 March 2017 through noon on 27 March 2017. It had slowed slightly to 11.67 knots by noon on 28 March 2017. The ship's main engine speed throughout the period was 64 revolutions per minute (rpm). The observed weather, as reported in the ship's Noon Reports, during this period was consistent with the forecast weather provided by StormGeo.
84. An updated weather forecast was transmitted by StormGeo to STELLAR DAISY at 0604 UTC on 29 March 2017. The forecast weather is shown in *Table 5*. This forecast also included predicted maximum significant wave heights.

¹³¹ STELLAR DAISY would also have received regular weather forecasts via NAVTEX.

Table 5: Forecast Weather Received 29 March 2017

Forecast (date/time)	Winds		Waves	Swells			Significant Waves		Maximum Waves
	Dir	Beaufort Force	Height (m)	Dir	Height (m)	Period (seconds)	Dir	Height (m)	Height (m)
30/0000Z	ESE	7	3.0	SSW	2.0	11	ESE	3.5	6.7
30/1200Z	ESE	7	3.5	SSW	2.0	11	ESE	4.0	7.6
31/0000Z	ESE	7	3.0	SSW	1.5	10	ESE	3.5	6.7
31/1200Z	ESE	7	3.0	S	3.5	16	S	5.0	9.5
01/0000Z	ESE	6	2.5	SSW	4.5	16	SSW	5.0	9.5
01/1200Z	SSE	5	2.0	SSW	3.5	15	SSW	4.0	7.6
02/0000Z	SSW	4	1.0	SSW	3.0	14	SSW	3.0	5.7
02/1200Z	SSE	4	1.0	SSW	3.0	14	SSW	3.0	5.7
03/0000Z	W	4	1.0	SSW	3.5	15	SSW	3.5	6.7

85. Although the main engine speed remained constant at 64 rpm, STELLAR DAISY's speed between noon on 29 March 2017 and noon on 31 March 2017 was just over 11 knots as the ship continued on a southeasterly course. Based on STELLAR DAISY's Noon Reports, throughout this period the observed winds were from the southeast at Beaufort Force 7 (28-33 knots). The seas were observed to be from the southeast as sea state 7 (6-9 m) (see Figure 9).¹³² According to statements from surviving crewmembers, STELLAR DAISY rolled normally and there was nothing about the ship's movement that felt unusual.

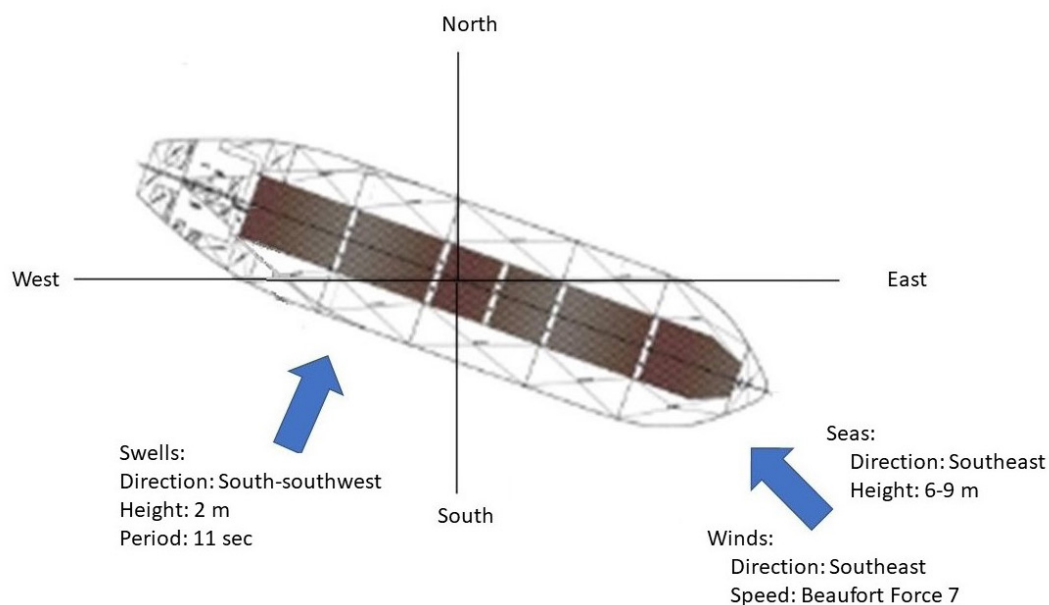

Figure 9: Wind and seas 29-31 March 2017.

¹³² The World Meteorological Organization defines sea state 7 as "high" with 6-9 m waves. See Manual of Codes (WMO-No. 306), volume I.1, Part A, Code Table 3700.

86. During the day on 29 March 2017, the cargo hold bilge pumping log was transmitted from STELLAR DAISY to Polaris Shipping.¹³³ Based on the soundings that were recorded between 27–29 March 2017, a total of 15.6 m³ of water accumulated in the cargo hold bilge wells during this period.¹³⁴ Further, based on the cargo hold bilge pumping log, no bilge water was discharged during this period.
87. At 1250¹³⁵ on 31 March 2017, based on LRIT information received from STELLAR DAISY, the ship's position was 18° 36.3' S, 034° 21.2' W. The ship was on a heading of 103° true at a speed of 11 knots.
88. At 1305 on 31 March 2017 a routine message was sent from STELLAR DAISY to the ship's Superintendent regarding inspections of the ship's immersion suits.
89. At 1320, a message was sent from STELLAR DAISY's Master to the ship's Superintendent reporting that the No. 2 P WBT was flooding and that the ship was developing a rapid list to port. No other details were provided. The Superintendent immediately replied requesting that the Master call him by INMARSAT. The Superintendent did not receive a reply.
90. At 1321, which was one minute after the message was sent to the ship's Superintendent reporting the No. 2 P WBT flooding, a Digital Selective Calling (DSC) distress alert was sent from STELLAR DAISY. At 1323, the ship's Superintendent tried again to call STELLAR DAISY via INMARSAT. The call was not answered.
91. One of two surviving crew members, an AB, who was then working inside the ship's accommodations due to the weather conditions, stated he heard a noise that sounded like an explosion.¹³⁶ He stated the ship then started to quickly develop a port list. The other surviving crew member, an Oiler, who was then working on the lower level of the Engine Room with the Wiper and Engine Cadet, stated he felt a rumble like an earthquake, which was immediately followed by the ship listing to port. The Oiler also reported that he heard the ship's main engine stop. Both the AB and the Oiler stated the port list increased continuously.
92. The AB stated he immediately went to his Cabin to put on his lifejacket. He then got his immersion suit and went to the muster station on the port side. When he arrived, no other crew members were at the muster station. The AB reported that he heard the Master announce, "All crew, go to Bridge" twice on the ship's public address (PA) system.
93. The AB proceeded to the Bridge using the outside ladders on the port side. According to the AB's statement, he saw the ship's Master, C/O, Second Officer (2/O), Third Officer (3/O), C/E, the other two ABs, the Chief Cook, the Second Cook, the Deck Cadet, and an Oiler inside the Bridge. He reported that all were wearing lifejackets except for the Master, C/E, and 3/O. The AB stated that the port list continued to increase and that soon after he arrived on the Bridge he heard the 3/O making a distress call on the VHF-FM radio.

133 In accordance with Polaris Shipping's SMS, the amount of water in each of the cargo hold bilge wells is recorded at 0800 and 1600 each day. The log is transmitted periodically throughout a laden voyage unless water was being pumped from the bilge wells, in which case the log is supposed to be transmitted daily.

134 As previously noted, the volume of each of the bilge wells was 4.86 m³. The volume of accumulated water in each of the bilge wells was between 2.43 m and 3.24 m.

135 Unless otherwise noted, all times from this point onwards are the ship's local time (UTC -1) on 31 March 2017.

136 The AB estimated that this was at approximately 1330. However, based on the times when distress communications were retransmitted by STELLAR DAISY (discussed in the pages that follow), it is likely this occurred sometime before 1330.

94. The AB stated that as the 3/O was making the distress call, he observed green water entering the Bridge through the door on the port side. He reported that the inclinometer indicated STELLAR DAISY had a 45° list to port (see Figure 10).¹³⁷ He also reported hearing a loud cracking sound on the port side but that he was not sure where it came from and that the ship rumbled like an earthquake. The AB reported he then ran out of the Bridge door and jumped into the water from the port side bridge wing. He did not provide an estimate of how long it was between when he first felt the ship start listing to port and when he entered the water.

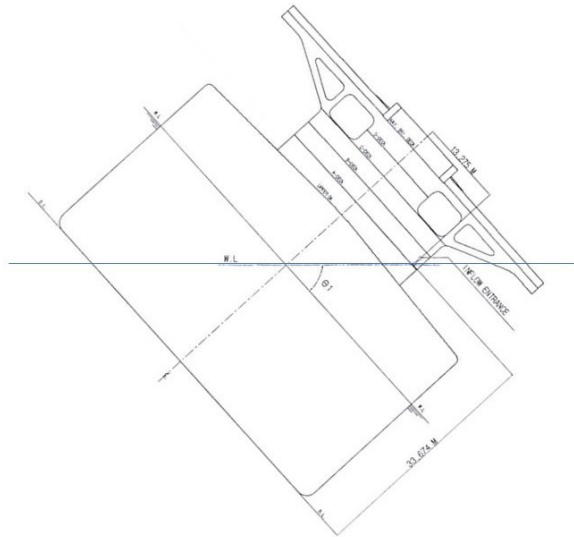

Figure 10: Looking aft, waterline at a 45° list to port with a loaded draft of 20.2 m. The waterline shown does not take into consideration any draft increase due to flooding. (Source: Stability and Loading Manual.)

95. The AB stated he went underwater and that when he surfaced, STELLAR DAISY was gone. He also stated that he did not see or hear any other members of the ship's crew. After surfacing, the AB grabbed an immersion suit that was floating nearby and then swam to an inflated life raft that was approximately 15 to 20 m away. After reaching the life raft, the AB climbed into it. According to the AB's statement, there was another inflated life raft that had capsized floating nearby.
96. The Oiler stated that he heard the Master announce, "All crew, go to Bridge" three times on the ship's PA system and that he, the Wiper, and Engine Cadet immediately left the Engine Room and went to the upper deck on the starboard side. He reported that upon reaching the starboard side door on the upper deck he went out on deck and grabbed hold of the life rail near the life rafts, which were stowed aft of the life boats on both the port and starboard sides. The Oiler stated he saw the Wiper and the Engine Cadet holding onto the door (see Figure 11). The Oiler also reported that the Bosun had reached the upper deck and said they should launch a life raft. Due to the port list, which continued to increase, they were not able to release the life raft. The Oiler stated that he then climbed to the outboard side of the life rail.

¹³⁷ Based on Polaris Shipping's calculations after STELLAR DAISY was reported lost, the down flooding angle was 43.338° , which is consistent with the value provided in the Stability and Loading Manual (p. 46).

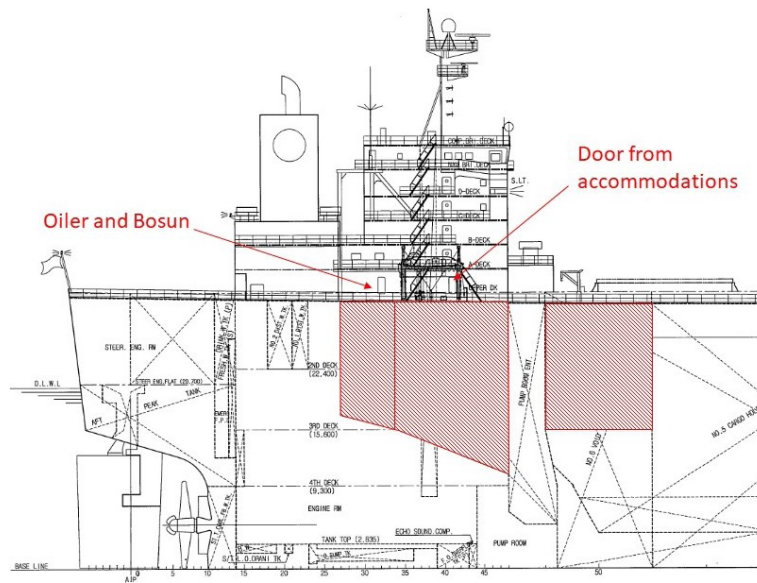

Figure 11: Location of Oiler and Bosun prior to the Oiler being washed overboard. The highlighted areas are fuel oil tanks (FOT). FOTs were in the same positions on the port side.

97. The Oiler described hearing what sounded like steel exploding. He then saw a wave of water and oil coming toward him from forward of the accommodations. The Oiler stated he was washed overboard when this wave hit him. The Oiler stated that he went underwater and was spun around before being pushed to the surface. He also stated the ship was gone when he surfaced and that he saw an immersion suit marked “BSN” floating nearby, which he grabbed. He then swam to a capsized life boat, which he stated was damaged on at least one side, and grabbed hold of it near the propeller. The Oiler put the immersion suit on while in the water in the vicinity of the life boat. After about 10 minutes, during which he reported calling out for other crewmembers and not receiving any response, the Oiler reported seeing two inflated life rafts, one of which was capsized, floating some distance away. He started swimming toward the life rafts while continuing to call for help.
98. The AB heard the Oiler and threw the life raft’s sea anchor to him. The AB then pulled the Oiler to the life raft and helped him in. The AB stated that the Oiler was covered in bunker oil and that he did not recognize him until after he cleaned his face. The AB and Oiler stated that they continued to look for other crew members but did not see anyone. At nightfall, they turned on the light inside the life raft and used a flashlight as they continued their search.

Search and Rescue

99. STELLAR DAISY’s Emergency Position Indicating Radio Beacon (EPIRB) was first detected by a COSPAS-SARSAT satellite at 1325, which was five minutes after the message was sent to the ship’s Superintendent reporting that the No. 2 P WBT was flooding. It is not known if the EPIRB was activated manually by a member of the ship’s crew, or automatically after floating free from the ship. The position of the EPIRB was confirmed 12 minutes later at 1337. The position was 34° 23.8’ S, 018° 30.2’ W, which

was more than 1,700 NM from the coast of Uruguay and 1,800 NM from the west coast of South Africa.¹³⁸ The nearest land was the Tristan da Cunha Islands, Saint Helena, approximately 330 NM to the south east (see Figure 12). The water depth in the area is approximately 3,400-3,600 m.

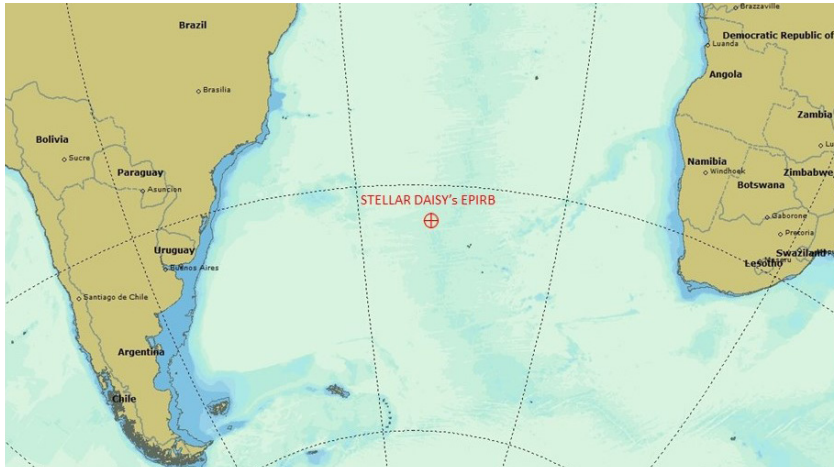

Figure 12: Position where STELLAR DAISY's EPIRB was detected by the COSPAS-SARSAT system on 31 March 2017.

100. At 1341, the Administrator was informed by the Joint Rescue Coordination Center (JRCC) Honolulu that STELLAR DAISY's EPIRB was transmitting. Within approximately 10 minutes, the Administrator telephoned Polaris Shipping's DPA to inquire whether they had received any reports that STELLAR DAISY was in distress.¹³⁹ The DPA subsequently informed the Administrator they had received a message from STELLAR DAISY indicating that the No. 2 P WBT was flooding and that the ship was listing rapidly to port.¹⁴⁰ The DPA also reported that Polaris Shipping had not been able to establish communications with the ship since receiving that message.
101. The search for STELLAR DAISY was coordinated by Maritime Rescue Coordination Center (MRCC) Uruguay. At 2300 on 31 March 2017, the Republic of Cyprus registered SPITHA (IMO No. 9290153) was the first ship to arrive in the area where the EPIRB was detected and reported seeing debris on the surface but no initial signs of survivors. SPITHA also reported that there was a strong smell of fuel oil. By the morning of 1 April 2017, the weather had improved and there were four ships on scene, including SPITHA, searching areas assigned by MRCC Uruguay. As the search continued, they were joined by other ships and long-range military aircraft.
102. At approximately 1345 on 1 April 2017, the Republic of Malta registered ELPIDA (IMO No. 9218284) reported finding two surviving crew members from STELLAR DAISY in a life raft in position 34° 04.7' S, 018° 32.3' W (see Figure 13). They were taken on board and identified as the AB, who had jumped into the water from the port Bridge wing, and the Oiler, who had been washed overboard from the upper deck on the starboard side.

¹³⁸ In February 2019, STELLAR DAISY was located in approximate position 34° 22.8' S, 018° 29.4' W during a deep-sea search conducted by the Republic of Korea. The Republic of Korea has provided the Administrator a copy of the video that was taken during the search. This video has been taken into consideration as part of the Administrator's marine safety investigation.

¹³⁹ The telephone call was followed by an email to the DPA, who was in Busan where the local time was 2350 (UTC +13) on 31 March 2017.

¹⁴⁰ This was the message received by the ship's Superintendent at 1320 on 31 March 2017.



Figure 13: Life raft with the two surviving crewmembers being approached by ELPIDA.

103. ELPIDA also reported sighting two life boats.¹⁴¹ Both life boats were floating capsized. The top of STELLAR DAISY’s No. 2 life boat was separated from the hull (*see Figure 14*). There were no indications that members of STELLAR DAISY’s crew were on board either of the life boats. Two additional life rafts were also sighted.¹⁴² One was reported to be floating upright in good condition without any of STELLAR DAISY’s crew onboard and the other was capsized.¹⁴³

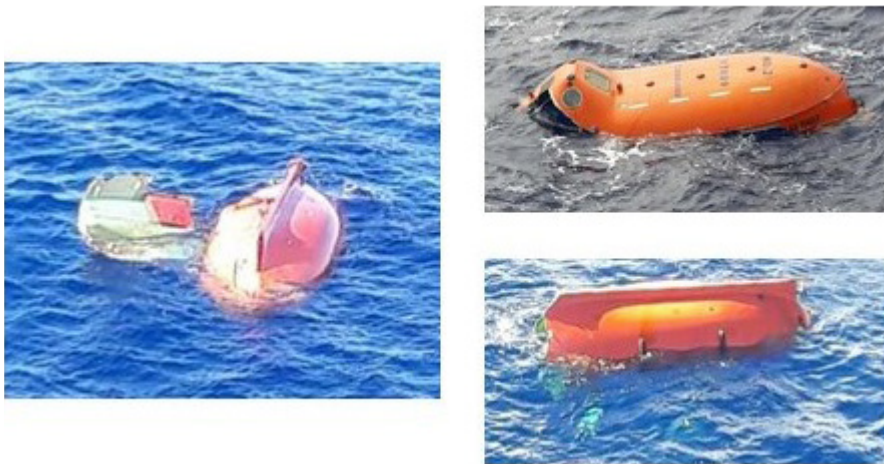

Figure 14: STELLAR DAISY’s life boats. The No. 1 life boat is on the left. The top and the hull of the No. 2 life boat, which were found floating separately, are on the right.

141 STELLAR DAISY was fitted with two, 30-person life boats.

142 STELLAR DAISY was equipped with four 15-person life rafts stowed on the life boat deck aft of the life boats with an aggregate capacity of 60 persons, or 200% of the maximum number of persons allowed to be carried on board STELLAR DAISY, and one life raft forward. Two of the life rafts stowed aft were stowed on the ship’s port side and two were stowed on the starboard side. The life rafts that were stowed aft were required to be able to float free when submerged to a depth of no more than 4 m. Given that the forward life raft was not required to float free, it is considered likely the life rafts that were found were three of the four life rafts stowed aft. It is not known which of the three rafts that were found were stowed on the port side and which were stowed on the starboard side. The aggregate capability of these life rafts would have been sufficient to accommodate 45 persons for at least 30 days.

143 It is not known what happened to the fourth life raft.

104. As the search continued during the day on 1 April 2017, ships on scene reported sighting an oil sheen that was approximately 15 to 25 NM long extending to the north, northeast in the area.
105. After being released from the search by MRCC Uruguay, ELPIDA disembarked the two rescued crew members in Cape Town, South Africa on 13 April 2017.
106. On 9 May 2017, MRCC Uruguay suspended the active search. Other than the two crew members who were rescued by ELPIDA, no other STELLAR DAISY crewmembers were found.

KR's Post-casualty Analysis

107. KR conducted a longitudinal strength assessment, structural analysis, and fatigue assessment after the loss of STELLAR DAISY.
108. The section modulus by KR Rules for Steel Ships when STELLAR DAISY was converted from a VLCC to a VLOC was 68.8 m³. The ship's deck and bottom section modulus within the midship half-length at the time of conversion and based on the thickness measurements done in 2012 and 2015 are shown in *Table 6*. The strength of individual structural members was based on the lowest measured thickness. KR determined the section modulus for the deck and bottom section likely decreased after 2015, but that the section modulus of the deck section was expected to have been more than 90% of the required value in 2017.¹⁴⁴

Table 6: Section Modulus						
BASIS	Frame No. 62		Frame No. 67		Frame No. 77	
	Deck	Bottom	Deck	Bottom	Deck	Bottom
Conversion Design	69.5 m ³ (101%)	95.5 m ³ (139%)	69.5 m ³ (101%)	95.5 m ³ (139%)	69.5 m ³ (101%)	95.5 m ³ (139%)
2012 Thickness Measurements	66.6 m ³ (96.8%)	92.9 m ³ (135%)	66.8 m ³ (97.1%)	92.9 m ³ (135%)	67.5 m ³ (98.1%)	93.1 m ³ (135%)
2015 Thickness Measurements	66.1 m ³ (96.1%)	91.5 m ³ (133%)	66.1 m ³ (96.1%)	92.2 m ³ (134%)	66.2 m ³ (96.2%)	92.7 m ³ (135%)

Percentages are based on the minimum required section modulus.

109. As part of KR's post-casualty analysis, STELLAR DAISY's bending moment was calculated at frames Nos. 55, 67, and 77 based on the conversion drawings and the loading condition and sea state when the ship was reported lost.¹⁴⁵ It was determined that the calculated bending moments were greater than the bending moments that were likely being encountered.
110. KR conducted a post-casualty FEA using two models. The first model was a half-breadth of the ship's hull in way of midships, which included Cargo Holds Nos. 3F and 3A, extended from frame No. 61 to frame No. 79. The second model was a half-breadth of the hull in way of Cargo Hold No. 2 and extended

¹⁴⁴ IACS requires that the section modulus in the deck and bottom zones of bulk carriers built to the Common Structural Rules for Bulk Carriers not be less than 90% of the required section modulus. IACS, Common Structural Rules for Bulk Carriers (2008 edition), Chapter 13, paragraph 3.3.2.

¹⁴⁵ The bending moments used for the comparison was for a sagging condition, which was less than the bending moment in a hogging condition.

from frame No. 72 to frame No. 87. The scantlings were based on an average of the thickness measurements done while the ship was in dry dock in 2015 in order to account for corrosion. The loading condition was based on the cargo on board on departure from the Ilha Guaiba Terminal on 26 March 2017.

111. KR determined that the FEA results indicated that the stresses in way of Cargo Holds Nos. 3F and 3A was within the limits allowed by the KR Rules for Steel Ships. An area of stress exceeding the allowed limits was identified in the web of the swash bulkhead located at frame No. 79 in way of where the hopper plate is welded to the longitudinal bulkhead. This frame is located at the middle of Cargo Hold No. 2 (see Figure 15). Similar areas of stress were not identified in the other frames included in the model of the half-breadth of the hull in way of Cargo Hold No. 2. KR determined that the stress was localized. The FEA was also conducted, using the as built scantlings, to determine if the results were related to the diminution of the structure due to corrosion. The stress in this area was determined to be slightly below the allowed limits and in compliance with KR Rules for Steel Ships.

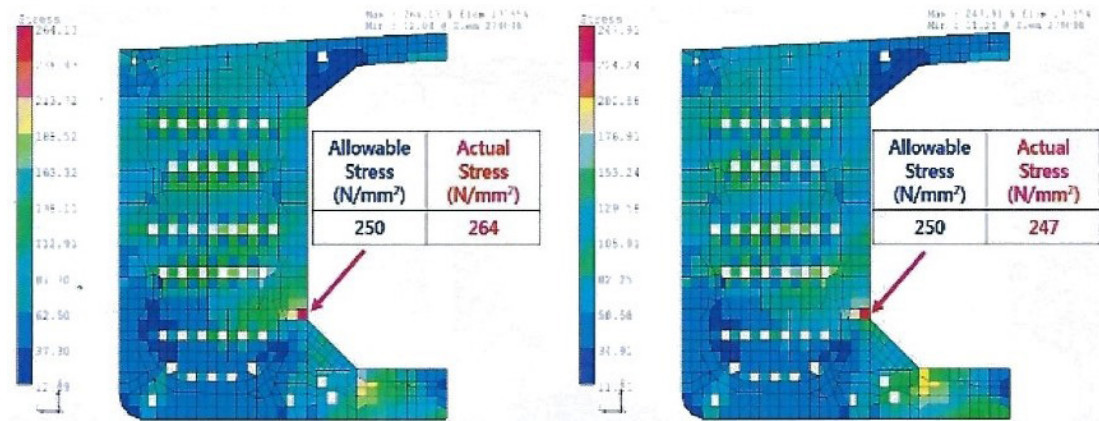

Figure 15: Stresses at frame No. 79 based on 2015 thickness measurements (left) and at time of conversion (right).

112. A buckling analysis in hogging and sagging conditions using the 2015 thickness measurements was conducted to determine if the transverse structure in way of Cargo Holds Nos. 2, 3F, and 3A met the buckling criteria in the KR Rules for Steel Ships. This analysis identified an area in the transverse web at frame No. 68 that slightly exceeded the allowed criteria. It also identified a portion of the transverse structure at frame No. 79, which was between the forward and aft hatches for Cargo Hold No. 2, that exceeded the allowed buckling criteria (see Figure 16).¹⁴⁶

¹⁴⁶ Frame No. 79 was the forward boundary for the FEA that was done at the time of the conversion and was included in the analysis that was conducted. It is noted that no buckling damage had been reported in this area while the ship was in service as a VLOC.

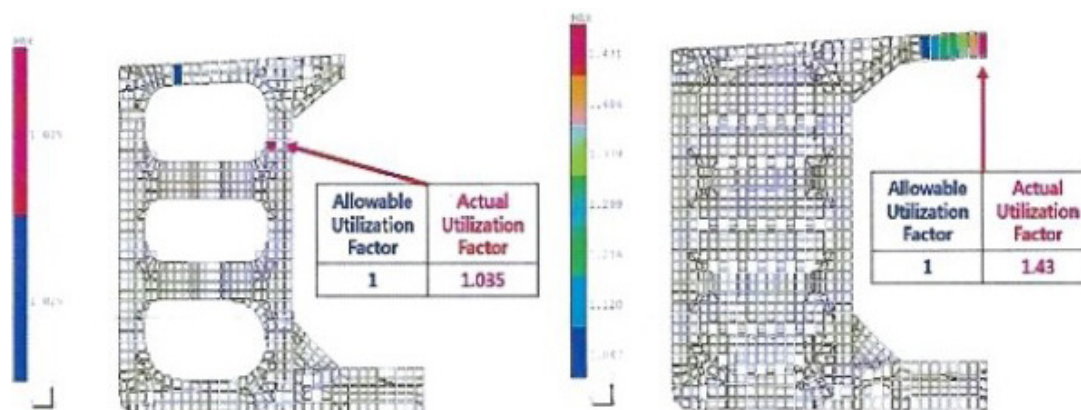

Figure 16: Locations where the structure did not meet the buckling criteria at frame No. 68 (left) and frame No. 79 (right).

113. The effect of multi-port discharges was considered as part of KR's post-casualty analysis.¹⁴⁷ The analysis indicated that the stress in the web of the swash bulkhead located at frame No. 79 significantly exceeded the allowed limits in way of where the hopper plate is welded to the longitudinal bulkhead.¹⁴⁸ The analysis also determined that stress in the centerline girder forward of frame No. 75 exceeded the allowed limits. Areas in the transverse structure supporting the floors of Cargo Holds Nos. 2, 3F, and 3A where the allowed buckling criteria was exceeded were also identified. KR determined the ship's structure should have been reinforced in order to conduct multi-port discharges.
114. KR also assessed the stresses associated with cargo liquefaction. This was done by assuming that the cargo would behave like a heavy liquid after liquefaction and that there would be a corresponding increase in pressure on the ship's structure. The assessment determined the stress in the web frames along the length of Cargo Hold No. 2 in way of where the hopper plate was welded to the longitudinal bulkhead, was 354 N/mm². It was also determined that the stress at this same location on the swash bulkhead located at frame No. 79 was 334 N/mm². The stress allowed by the KR Rules for Steel Ships is 250 N/mm². KR determined that the scantlings for the longitudinal bulkhead plate and longitudinals and the transverse bulkhead plates and vertical stiffeners, while sufficient for a dry bulk cargo, were not sufficient to withstand the forces associated with a liquefied cargo.
115. Given the potential that the cargo had shifted by the time STELLAR DAISY was listing 45° to port, KR conducted a strength assessment of the hopper plates and the longitudinal bulkheads. The purpose of the assessment was to determine if the as built scantlings of the plate and longitudinals for the hoppers and longitudinal bulkheads met the requirements of the KR Rules for Steel Ships when subject to increased pressure following a cargo shift.¹⁴⁹ For this assessment, it was assumed that at a 45° list the top of the cargo pile was flat (see Figure 17). It was determined that although the as built scantlings for the hopper

147 STELLAR DAISY had twice discharged cargo in multiple ports in the 12 months prior to when the ship was reported missing. In August 2016, a multi-port discharge was conducted in Lianyungang and Rizhao and in February 2017 a multi-port discharge was conducted in Tianjin and Caofeidian, China. It is noted that both of these multi-port discharges required a coastal transit of approximately 25-30 NM.

148 This is the same location where an area of high stress was identified when the ship was fully loaded (see Figure 12). The calculated stress for this location when the ship was fully loaded was 264 N/mm². The stress in a partially loaded condition was 328 N/mm². The allowable stress was 250 N/mm².

149 It is noted that the scantling requirements in the KR Rules for Steel Ships are based on cargo pressures when the ship is not listing. See KR Rules for Steel Ships, Part 3, Annex 3-2.

plate and longitudinals exceeded the scantlings required to support the increased pressure, the as built scantlings for the longitudinal bulkhead plate and longitudinals did not meet the required scantlings. Based on this analysis, KR determined that the longitudinal bulkheads could fail between transverse frames following a cargo shift.

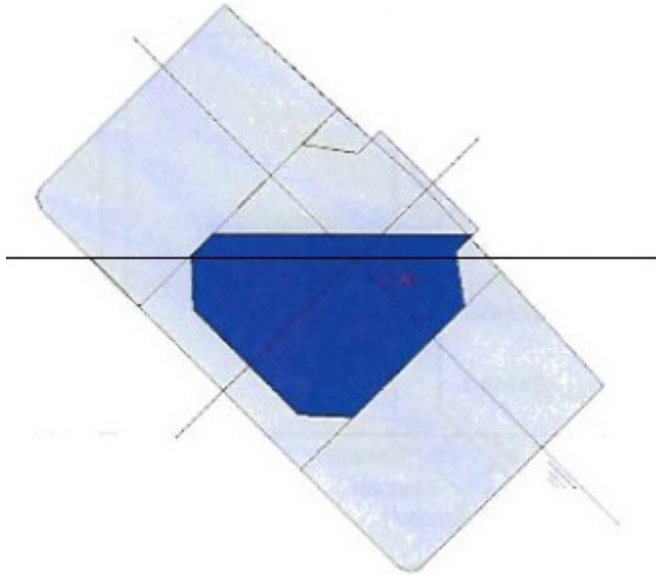

Figure 17: Assumed shape of cargo pile after shifting when ship's list was 45° to port. The change of draft due to flooding is not shown.

116. KR's post-casualty fatigue strength assessment of the conversion design was based on the as built scantlings that were part of the ship's original structure and the scantlings fitted during the conversion.¹⁵⁰ The assessment determined that:
- (a) the side shell longitudinal end connections at the transverse bulkheads at frames Nos. 70 and 75¹⁵¹ in way of the waterline in ballast and loaded conditions,¹⁵² which is the area of highest cyclic loading had expected fatigue lives of more than 30 years and the end connections of the side shell longitudinals located between the bottom shell and the No. 3 horizontal girder at these same frames had calculated fatigue lives that were more than 50 years;
 - (b) all the side shell longitudinal end connections at web frames Nos. 69, 71, and 78 had expected fatigue lives of more than 50 years;
 - (c) the end connections for all the under deck longitudinals at frames Nos. 69, 71, and 78 and under deck longitudinals Nos. 14-19 and 26-31 at frame No. 75 had calculated fatigue lives of over 30 years, and the end connections for under deck longitudinals Nos. 20-25 at frame No. 75 had fatigue lives over 50 years; and
 - (d) all the bottom longitudinal end connections at frames Nos. 69-71, 75, and 78 had calculated fatigue lives that were greater than 50 years.

¹⁵⁰ KR's guidance for conducting fatigue strength assessments include provisions that take the effect of corrosion and welding defects, local notch effect, into consideration. KR Rules for Steel Ships, Part 3, Annex 3-3, paragraph 3(C).

¹⁵¹ The transverse bulkhead at frame No. 70 is a swash bulkhead in the middle of No. 3 P/S WBTs. The transverse bulkhead at frame No. 75 is the bulkhead between the No. 2 P/S WBTs and No. 3 P/S WBTs.

¹⁵² These drafts ranged between 8.49 m and 20.3 m. See Stability and Loading Manual.

117. KR conducted an additional fatigue strength assessment of the side shell longitudinals in way of frame No. 75. Although not a standard KR practice, this assessment took into consideration the thickness measurements completed in 2015 to determine the expected remaining fatigue lives of these end connections. The calculated fatigue lives of the end connections in way of the waterline in a loaded condition were reduced to between 27.4 and 29.4 years. KR noted these calculated fatigue lives did not account for how repairs made while STELLAR DAISY was in service as a VLOC may have impacted the hull structure.
118. KR noted that calculated fatigue lives are based on the standards and assumptions applied when the assessment was conducted and do not reflect actual corrosion rates or repairs that might be required while the ship is in service.
119. Based on a review of post-casualty inspection records for the other 18 converted VLOCs managed by Polaris Shipping and classed by KR, a total of 58 cracks in the bottom longitudinals and 73 cracks in side shell longitudinals were identified in WBTs and wing voids. The locations where these cracks were found relative to a transverse bulkhead is summarized in *Table 7*. On some of these converted VLOCs more than one crack was reported in a tank. Most of these cracks were identified after the loss of STELLAR DAISY on 31 March 2017. KR reported that cracks were typically in structural members that were not renewed when the ship was converted. The primary cause of the identified cracks was fatigue.

Table 7: Summary of Cracks Based on Location Relative to Transverse Bulkhead

Location	Bottom Longitudinals	Side Shell Longitudinals
In Way of Transverse Bulkhead	38	0
Not In Way of Transverse Bulkhead	20	73
Total	58	73

120. Cracks were found in bottom longitudinals in way of a transverse bulkhead on other ships that either had brackets forward of the bulkhead only or had brackets on both sides of the bulkhead. STELLAR DAISY had 1,500 x 1,500 x 12.5 mm brackets fitted with a 150 x 12.5 mm buckling plate on the forward side of the transverse bulkheads and smaller 675 x 650 x 16 mm soft toe brackets on the aft side of the bulkheads (*see Figure 18*). KR determined that 21 of the cracks reported in bottom longitudinals were not fitted with a bracket. The other 17 extended from the toe of the bracket. In addition, on some of the converted VLOCs two or more adjacent bottom longitudinals were found cracked in the same tank.

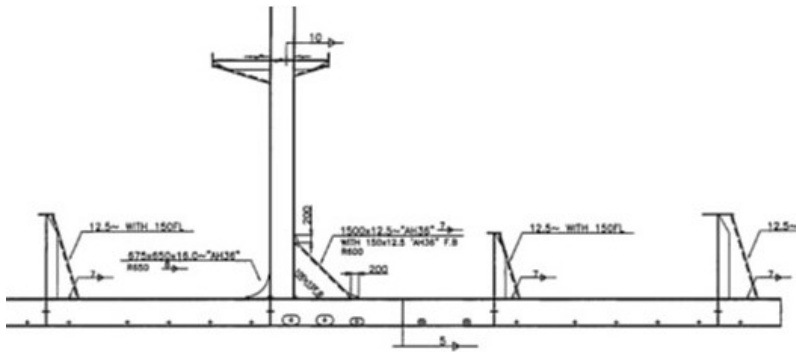

Figure 18: Bottom longitudinal brackets in way of the transverse bulkhead in the wing tanks.

121. To assess the effect of flooding, KR analyzed two flooding conditions. The first was with No. 2 P WBT flooded and the second was with Nos. 2 and 3 P WBTs flooded.
- Based on KR's calculations, with No. 2 P WBT flooded the ship would have reached a condition of equilibrium per ICLL 1966 as amended by the Protocol of 1988, regulation 27(13) at approximately 7° of list. Based on STELLAR DAISY's actual loading conditions for Voyage 041, the ship would have been at equilibrium when the tank was flooded with 18,791 MT of sea water. The righting lever remained positive up to 36.6° of list. It was also determined that the forward draft would have increased to 23.02 m and that the ship would be trimmed just over 3 m by the bow. Based on these calculations KR determined the damage stability criteria was satisfied when No. 2 P WBT was flooded.
 - KR calculated that with both Nos. 2 and 3 P WBTs flooded to 95% capacity the righting lever remained positive up to a list of 21.4° . The ship would have had a list of approximately 18° to port. The edge of the deck and air vents for No. 4 P WBT would have been submerged. The forward draft would have increased to 26.59 m and the trim by the bow increased to 6.18 m. KR also determined that given the existing weather conditions and the small residual stability, the ship would sink over a period of time due to down flooding of No. 4 P WBT through the submerged air vents.
122. KR determined that with No. 2 P WBT flooded, the bending moment would have been 81% and the shear force would have been 66% of the maximum at-sea values. With Nos. 2 and 3 P WBTs flooded, the calculated bending moment was 192% and the shear force was 80% of the allowed at-sea values. Using the calculated bending moments based on the ship's loaded condition as a reference, the maximum still water bending moment increased by approximately 100% when No. 2 P WBT was flooded and by 400% when Nos. 2 and 3 P WBTs were flooded. The location of the maximum bending moment was at frame No. 55 when the ship was in an intact condition, between frame Nos. 78 and 79 when No. 2 P WBT was flooded and between frame Nos. 78 and 79 when Nos. 2 and 3 P WBTs were flooded (see Figure 19).

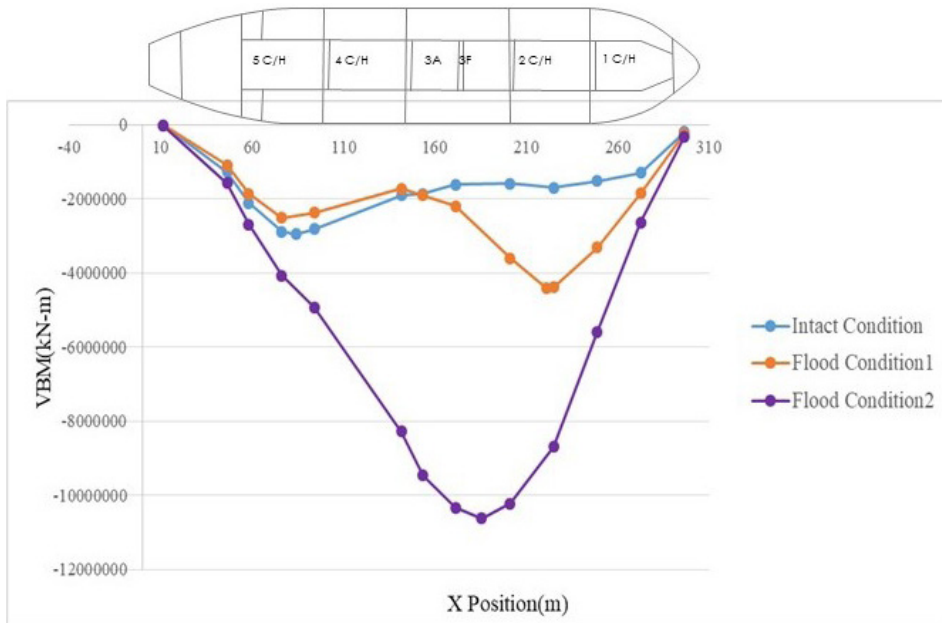

Figure 19: Still water bending moments.

123. KR evaluated the potential for the ship’s transverse structure to buckle when No. 2 P WBT was flooded to the point where the ship would have been in equilibrium per ICLL 1966 as amended by the Protocol of 1988, regulation 27(13). Taking into consideration the ship’s loaded condition and the weather conditions that existed from 29–31 March 2017, it was determined that portions of the transverse structure between the hatch openings for Cargo Holds Nos. 2-5 would likely buckle (*see Figure 20*). KR also determined that buckling of the transverse structure would likely have begun before the tank was flooded to the point where the ship would have been in equilibrium.

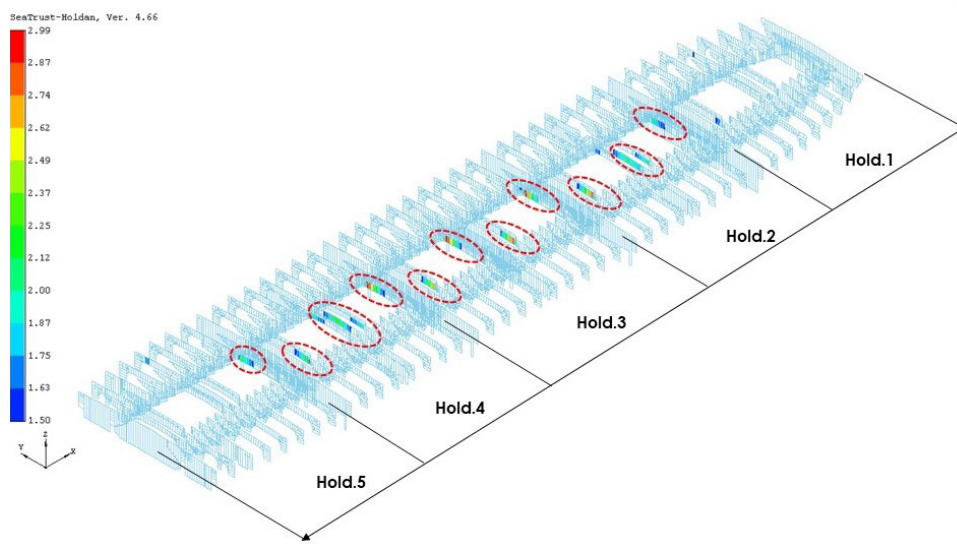

Figure 20: Areas of potential buckling of the transverse structure with No. 2 P WBT flooded.

- 124. KR’s analysis determined the buckling of the transverse structure would likely cause the cross deck between Cargo Holds Nos. 1 and 2, Nos. 2 and 3F, Nos. 3F and 3A, and Nos. 3A and 4 to collapse. The buckling would result in cracks forming in the deck plate and deflection of the hatch coamings and covers. It would also cause some damage of upper sections of the transverse bulkheads between each of the ship’s cargo holds.
- 125. The buckling analysis was also conducted with both the No. 2 P and No. 3 P WBT flooded. The analysis indicated that buckling of the transverse structure between hatch openings would be more severe than with only the No. 2 P WBT flooded. It was also determined that multiple transverse bulkheads between cargo holds would likely collapse. The analysis also indicated that deck plate outside of the line of hatch openings would also be damaged. In addition, the deflection of the hatch coamings and covers would become more severe (see Figure 21).

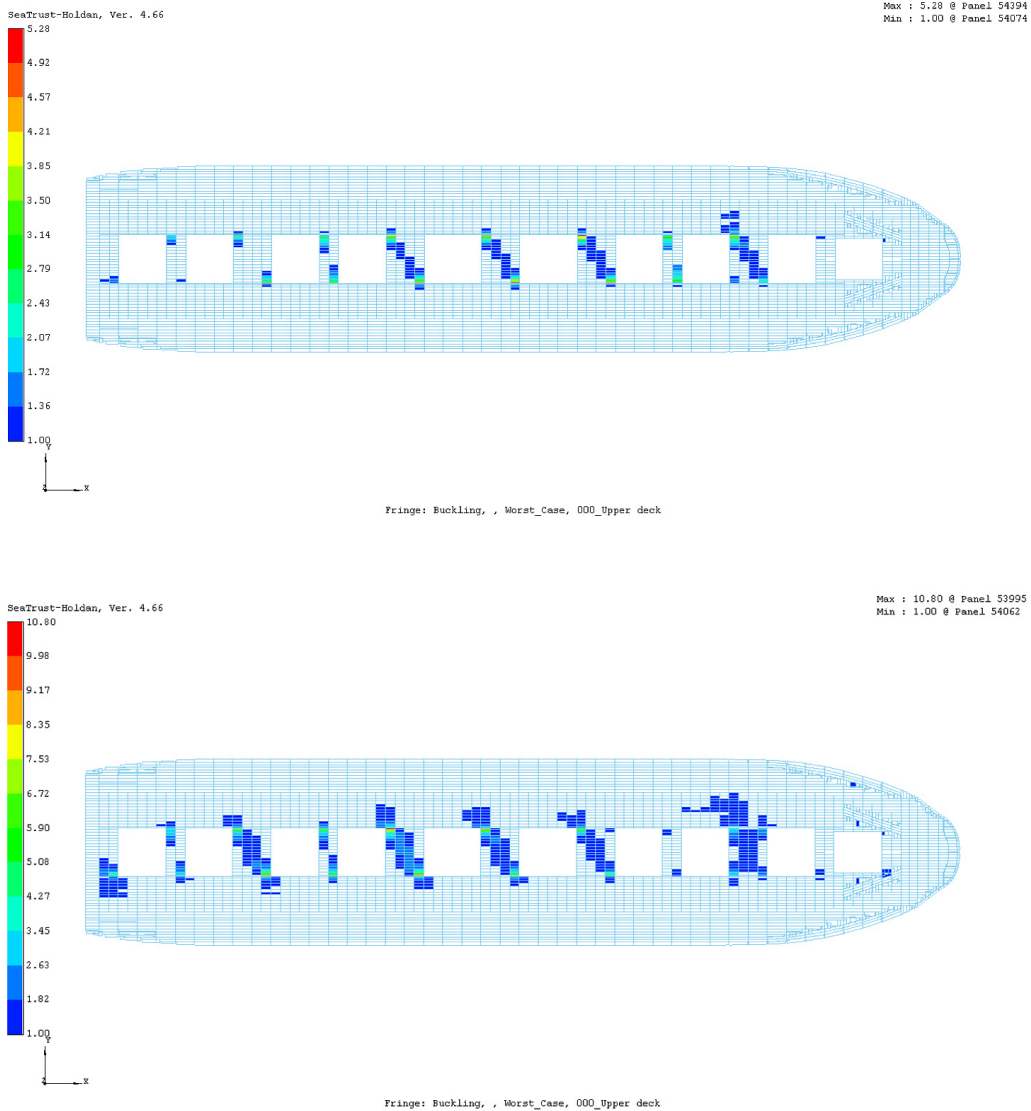

Figure 21: Areas of the deck where the buckling criteria was exceeded with No. 2 P WBT flooded (upper) and with Nos. 2 and 3 P WBTs flooded (lower).

Inspection and Repair of Other VLOCs in Polaris Shipping's Managed Fleet

126. Following the loss of STELLAR DAISY, Polaris Shipping informed the Administrator that Masters of all the ships in their managed fleet had been directed to conduct internal structural inspections. On 7 April 2017, the Administrator received a report that a crack in the side shell in way of the No. 1 S Void of STELLAR UNICORN¹⁵³ had been found while the ship was underway in the South Atlantic Ocean on a laden voyage from Brazil to China and that the ship was off Cape Town. A joint structural inspection of STELLAR UNICORN was conducted by Polaris Shipping, KR, and the Administrator from 10–11 April 2017 while the ship was off Cape Town. This inspection identified a 170 mm long vertical fracture in the side shell just below the load water line in the No. 1 S Void. Other damage observed around the fracture included: the side shell was indented slightly; the side longitudinals were excessively buckled and distorted; and the frames were slightly distorted in the same area. The damaged area was in way of a tug assist point.¹⁵⁴ It was also determined that the coatings in the voids and WBTs were poor.¹⁵⁵
127. Considering the loss of STELLAR DAISY and the cracks found on STELLAR UNICORN, Polaris Shipping engaged KR to conduct structural inspections of the 18 VLOCs in their managed fleet.¹⁵⁶ In addition, the Administrator also conducted structural inspections of the 11 converted VLOCs managed by Polaris Shipping that were registered in the Republic of the Marshall Islands. These inspections, which were conducted between April and August 2017 when each of the ships was in a lightship condition in coordination with KR, whose surveyors were on board to conduct close-up inspections, which included taking thickness measurements. Based on the results of these inspections, Polaris Shipping, working with KR, developed ship specific repair plans.
128. The inspection of the 11 converted VLOCs managed by Polaris Shipping that were registered in the Republic of the Marshall Islands identified the following:
- (a) areas of fatigue were found on most of the ships;
 - (b) the under deck areas were a high-risk area on all of the ships;
 - (c) the rating of the coatings in the voids and WBTs on some of the ships as fair did not appear to be consistent with IACS guidance for assessing coating condition;¹⁵⁷
 - (d) the structural repairs that had been made in the shipyard or as voyage repairs were generally: not based on any structural analysis, completed without a detailed repair plan, and commonly accomplished using short inserts;¹⁵⁸ and
 - (e) voyage repairs were not consistently reported to the ship's Classification Society.¹⁵⁹

153 STELLAR UNICORN (IMO No. 9006734) was built as a VLCC in the Sasebo Heavy Industries Co., Ltd. shipyard in 1993. The ship was converted to a 279,022 DWT VLOC at the Yiu Lian shipyard in Shekou, China in 2009.

154 A review of the Administrator's records did not locate any reports of a collision or allision involving STELLAR UNICORN.

155 Temporary repairs were completed to the satisfaction of KR at Cape Town. After cargo was discharged, the ship was laid up at Lebuan, Brunei Bay, Malaysia. Polaris Shipping subsequently elected to scrap the ship.

156 Polaris Shipping contracted Lloyd's Register (LR) to attend the inspections of these ships, each of which had been converted from a VLCC to a VLOC, as a third party.

157 IACS, Recommendation 87 Guidelines for Coating Maintenance & Repairs for Ballast Tanks and Combined Cargo/Ballast Tanks on Oil Tankers. Although these guidelines are applicable to oil tankers, KR informed the Administrator that they are used by their surveyors to assess the condition of coatings on other types of ships, including bulk carriers.

158 For example, *see* the description of the steelwork performed on STELLAR DAISY while in dry dock at the COSCO (Dalian) in 2015 as outlined previously in this report. As previously noted, IACS Recommendation No. 47 requires that inserts be a minimum of 300 mm long, although in some circumstances inserts as short as 200 mm can be accepted.

159 As previously noted, KR is required to be notified in advance when repairs will be conducted by a riding crew during a voyage. KR Rules for Steel Ships, Part 1, Chapter 2, section 107.



PART 3: ANALYSIS

The following Analysis is based on the above Findings of Fact.

Cargo Issues

Potential safety risks associated with iron ore fines that have been identified by the IMO include:¹⁶⁰

1. hull damage during loading due to overstressing the cargo hold tank top;
2. exceeding the allowed bending moment or shear force during loading; and
3. loss of stability due to cargo liquefaction.

In addition, a ship's structure, including the cargo hold hatches and coamings can be damaged by the terminal's loader.

¹⁶⁰ SOLAS, regulation VI/7 and the Schedule for Iron Ore Fines, IMSBC Code, as amended by IMSBC Amendment 03-15 (IMO Resolution MSC.393(95)).

Cargo Loading

Due to the high density of iron ore fines, the cargo hold tank top and associated structure can be overloaded if the cargo is not evenly distributed. To evenly distribute the cargo during loading at Vale's Ilha Guaíba Terminal, the loader is moved during each pour. Based on the information available to the Administrator, it is not considered likely that how the iron ore fines were distributed in the cargo holds during loading at Vale's Ilha Guaíba Terminal was a contributing cause of the loss of STELLAR DAISY.

As the cargo holds were filled, the ship's structure may have been subject to localized stresses that would contribute, over time, to material fatigue. As described above, material fatigue can increase the potential for cracking. However, these localized stresses and resulting fatigue were unlikely to be sufficient to initiate a structural failure that could have caused the loss of STELLAR DAISY.

The manner in which the cargo is distributed among the cargo holds during the loading process is critical for ensuring that the allowed bending moments or shear forces are not exceeded during the loading process or when the ship is at sea. Equally important is ensuring that ballast water is discharged at a high enough rate and from the correct WBTs to keep the bending moments and shear forces within allowed limits throughout the loading process. Based on a review of the plan for loading STELLAR DAISY at Vale's Ilha Guaíba Terminal between 23–25 March 2017, the calculated bending moments and shear forces were well within the maximum allowed limits. There is also no indication that there were any problems with the ship's ballast system as cargo was loaded. Although records of the actual longitudinal forces on the ship's hull during and upon completion of loading are not available, it is not considered likely that either the maximum allowed bending moments or shear forces were exceeded during loading.

There is no indication that STELLAR DAISY's structure or cargo hatches and coamings were damaged during loading at the Ilha Guaíba Terminal.

Cargo Liquefaction

The hazards of cargo liquefaction are well known. Cargoes that can liquefy include iron ore fines. According to the Certificate of Moisture Content provided by Vale to STELLAR DAISY's C/O for the cargo of iron ore fines loaded at the Ilha Guaíba Terminal between 23–25 March 2017, the MC was 9.23% and the TML was 11.44%. The MC was assessed on 22 March 2017. The TML was assessed on 28 September 2016 and was valid through 27 March 2017. Other than approximately 0.05 cm of rain that was recorded at Santa Cruz at 0500 on 22 March 2017, there was no documented rainfall at the Ilha Guaíba Terminal between 22 March 2017, when the MC was assessed, and 25 March 2017 when STELLAR DAISY had completed loading. Based on the Certificate of Moisture Content, the cargo was safe to load.

The MC and TML of the cargo was determined by the terminal's lab. The lab is certified by the Brazilian Navy Directorate of Ports and Coasts, the competent authority for the loading port. It is also noted that the terminal will not permit ship's Masters or representatives to examine the cargo stockpiles or obtain cargo samples for independent testing prior to loading. As a result, the process of determining the potential risk of a cargo liquefying is controlled by the shipper without third-party oversight.

In addition, the soundings of the ship's cargo hold bilge wells indicated that a total of 15.6 m³ of water accumulated in the cargo hold bilge wells between 27–29 March 2017. In contrast, a study of Brazilian iron ore fines cargoes reported that for one cargo of iron ore fines an average of 60 m³ per day of cargo hold bilge water was pumped, and that for another cargo an average of 20 m³ of cargo hold bilge water was pumped approximately every three days.¹⁶¹ The low volumes of cargo hold bilge well water is an indication that the micro-filtration system might have been clogged. However, this is not considered likely since low volumes of bilge water were recorded for each of the ship's 12 cargo hold bilge wells.

A typical Capesize bulk carrier is expected to have sufficient stability to survive with liquefied cargo in half of its cargo holds. This is because the reserve stability of these ships is typically 10 times more than required by the IS Code.¹⁶² In contrast, the reserve stability of STELLAR DAISY on departure from the Ilha Guaíba Terminal was more than 25 times greater than required by the IS Code (*see Table 3*). Further, provided there was not a breach of the ship's hull, STELLAR DAISY had significantly more reserve buoyancy than a typical Capesize bulk carrier due to the magnitude of the ship's beam and wing tanks (*see Figure 3 and Table 2*). However, KR's post-casualty structural analysis, determined the stresses due to cargo liquefaction in way of where the hopper plate landed on the longitudinal bulkhead were much greater than the allowable stresses. The implication is that there was the potential for the longitudinal bulkheads and supporting structure to fail if STELLAR DAISY's cargo had liquefied.

The surviving crewmembers, both of whom were experienced seafarers, reported the ship was rolling normally before they had any indication that something was wrong. Typically, if a cargo liquefies, it will flow to one side of the cargo hold as the ship rolls. The ship will roll back in the other direction, but not as far as when rolling normally. This asymmetric roll can cause the ship to reach a dangerous angle of heel and capsize quite suddenly.¹⁶³

Based on the assessed MC and TML, the absence of precipitation between when the MC was assessed and completion of cargo loading, and the volume of water that accumulated in STELLAR DAISY's cargo hold bilges while the ship was at sea, the cargo loaded at Ilha Guaíba Terminal posed a low risk of liquefaction. Considering that the surviving crewmembers did not report any change in the ship's roll until after it became apparent something was wrong, it is unlikely that cargo liquefaction was an initiating cause of the loss of STELLAR DAISY.

KR's post-casualty structural analysis determined the stresses in way of where the hopper plate landed on the longitudinal bulkhead were much higher than the allowable stresses. The implication is that there was the potential for the longitudinal bulkheads and supporting structure to fail if STELLAR DAISY's cargo had liquefied.

161 IMO Sub-committee on Dangerous Goods, Solid Cargoes and Containers, 18th Session, Technical Working Group Report #2 "Marine Report" (DSC 18/Inf.11), Annex 1, p. 100. The TML and MC of these cargoes was not included in the report.

162 DSC 18/Inf.11, Annex 1, p. 72.

163 IMSBC Code, paragraph 7.2.4.

Voyage Related Factors

After disembarking the Pilot on 26 March 2017, STELLAR DAISY maintained a southeasterly course toward the Cape of Good Hope. The weather worsened approximately two days after the ship's departure. Based on the ship's Noon Reports, Beaufort Force 7 winds and 6-9 m waves from the southeast were encountered for at least 72 hours before flooding was reported in the No. 2 P WBT. Based on the StormGeo forecast, there were also approximately 2 m swells from the southwest during this period (*see Figure 9*).

The combination of waves from the southeast and the swells from the southwest created the potential for occasional synchronous rolling, which would have resulted in increased pressures on the ship's shell plate.

After commencing the sea passage, the main engine speed was maintained at approximately 64 rpm. Most likely this was to try to keep the ship's speed as close to the charter party speed of 12 knots as possible. Based on information available, this was a standard practice. Although the main engine speed remained constant, the ship's speed decreased from approximately 12 knots to 11 knots due to the existing weather conditions. Encountering 6 to 9 m head seas at 11 knots would have imposed significant impact loads on the forward structure of the ship. These loads would have been magnified when the ship encountered a wave as the bow was pitching down. The resulting vibrations would have been transmitted aft through the ship's hull.

The weather conditions encountered by STELLAR DAISY while crossing the South Atlantic Ocean were not extreme and were common for the area at that time of year. Further, they were conditions STELLAR DAISY had encountered on prior voyages and that the ship should have been able to withstand. However, because the strength of the ship's structure was compromised (*see following section Ship's Structural Condition*), the dynamic loads resulting from this combination of forces had a higher potential to cause components of the hull structure to fail. Further, although Polaris Shipping's SMS did include a statement that Masters had the authority to respond to all emergencies or abnormal circumstances, prior to the loss of STELLAR DAISY the SMS did not include specific guidance for Masters to reduce speed or change course based on the existing weather conditions.

Changing course could have reduced the potential for synchronous rolling and would have reduced the magnitude of the dynamic forces on the ship's structure. Whether this reduction would have been sufficient to prevent the structural failure that initiated the loss of buoyancy cannot be determined based on the information that is available.

Ship's Structural Condition

The structural condition of STELLAR DAISY immediately prior to the ship being reported lost on 31 March 2017 is not known. However, based on the records that are available it is possible to make some general observations regarding the ship's structural condition and whether this was a contributing cause of the ship sinking.

Material Fatigue

When built in 1993, STELLAR DAISY's likely expected design life was approximately 20 years. As the ship aged, the hull structure was subject to fatigue due to being subject to dynamic and static loads while in service. The FEA that was completed when the ship was converted to a VLOC did not take this fatigue into account, but rather assumed all scantlings were as original. In addition, any fatigue that may have occurred while the ship was in service as a VLCC was not taken into consideration when the conversion design was assessed and approved.

STELLAR DAISY's structure after conversion included significant quantities of new steel, it also consisted of significant quantities of original steel. This original steel would have experienced some reduction in fatigue life during the ship's 15 years of service as a VLCC and subsequently during the ship's eight years of service as a VLOC. As a result, although the FEA that was completed to support KR's approval of the conversion design considered the effect of corrosion and local notch effect, critical areas of the ship's structure were prone to fatigue cracking.

The end connections for many of the side shell, bottom shell, and deck longitudinals were the original structure consisting of high tensile strength steel. Based on the fatigue strength assessment conducted by KR following the loss of STELLAR DAISY, the longitudinal end connections with the shortest calculated fatigue lives were those for the side shell longitudinals in way of the waterline in ballast and loaded conditions,¹⁶⁴ which is the area of highest cyclic loading.

The calculated fatigue lives of the end connections for the side and bottom longitudinals are based on the standards and assumptions applied when the assessment was conducted. Calculation of fatigue life uses statistics as it is probabilistic. It cannot be assumed that the stated fatigue life will be achieved. Failures, most commonly cracking, can occur before the fatigue life is achieved. Further, calculated fatigue lives do not reflect actual stresses on the hull structure, corrosion rates, or repairs that might be required while the ship is in service.

As previously stated, a total of 58 cracks in the bottom longitudinals and 73 cracks in side shell longitudinals were identified in WBTs and wing voids of STELLAR DAISY and the other converted VLOCs managed by Polaris Shipping and classed by KR. Most of these were found after the loss of STELLAR DAISY and in some cases there were two or more bottom longitudinals in a single tank that were cracked. Of the cracks in bottom longitudinals, 38 were in way of a transverse bulkhead. Further, most of these cracks were found in original structural members that had not been renewed at the time of conversion. It is also noted that most of the repairs required when the ship was in dry dock in 2011, 2012, and 2015 were to renew structural members that were part of STELLAR DAISY's original structure when the ship was built in 1993. Although some of the repairs were required due to corrosion, many were required to repair cracks.

As previously noted, there are also no records indicating KR conducted a failure analysis of the various cracks that were repaired in 2011, 2012, and 2015. Similarly, there is no record that samples of the steel that had cracked were tested in a laboratory. Given the ship's large GM_0 both in ballast and when laden, it is

¹⁶⁴ These drafts ranged between 8.49 m and 20.3 m. See Stability and Loading Manual.

considered likely that some of these cracks, including the cracked collar plates around slot holes on the horizontal girders and damaged vertical stiffeners, were due to high transverse stresses imposed on the hull structure when rolling in beam seas, which would have been common given the ship's trading pattern.¹⁶⁵ The resulting distortion of the transverse structure due to the uneven distribution of force on the side shell vertically from the shear strake to the turn of the bilge would be expected to cause some distortion of the ship's transverse structure. This distortion would have been transmitted to the transverse bulkheads, web frames, and longitudinal end connections as shear force.

Corrosion

Deterioration of internal structural members and the resulting loss of strength due to corrosion is a known problem. The loss of material results in the structural member becoming more flexible and increases the potential for failure with each stress cycle. Corrosion can also cause notches that can result in areas of increased stress. The risk of corrosion in a WBT if left unchecked is particularly high. To protect against corrosion, KR's Rules for Steel Ships require that WBTs are coated and fitted with anodes.

Based on the KR survey reports, when STELLAR DAISY was dry docked in 2011, the condition of the coatings in the No. 2 P/S WBTs and No. 4 P/S WBTs was fair and the condition of the coatings in the No. 3 P/S WBTs was poor. In 2012, new coatings were applied in the No. 3 S WBT and the condition was upgraded to good. There was no change to the condition of the coatings in the other WBTs. In 2015 and 2016, KR reported the condition of the coatings in the No. 2 P/S WBTs, No. 3 S WBTs, and No. 4 P/S WBTs as fair and the condition of the coatings in the No. 3 P WBT as poor. In contrast, in 2016, the ship's Masters had rated the condition of the coatings in the No. 2 P/S WBTs and No. 4 P/S WBTs as poor, although better than the condition of the coatings in the No. 3 P/S WBTs. The Masters also reported that most of the coatings near the bottom of the tanks had failed.

The zinc anodes in the WBTs were replaced at each dry docking. According to the Masters' inspections, the anodes showed significant consumption in 2016. This is consistent with the Master's assessment that the coatings in the No. 2 P/S WBTs and No. 3 P/S WBTs were poor.

STELLAR DAISY's repair history indicates that there was active corrosion in the No. 2 P/S WBTs and No. 4 P/S WBTs, tanks in which the coatings were rated by the KR surveyor as fair. Most of the repairs documented by the attending KR surveyor when STELLAR DAISY was dry docked in 2012 and 2015 were to renew corroded structural members in these tanks. Many of these repairs were for under deck longitudinals, which is consistent with the Administrator's inspection findings conducted on the other VLOCs managed by Polaris Shipping that were registered in the Republic of the Marshall Islands. As discussed above, more repairs in these tanks were completed in 2015 than were documented by the KR surveyor.

The shipyard's work done reports did not indicate whether a renewal was required because of corrosion or due to a fracture. Considering that the KR survey reports did not document all the renewals that were included on the shipyard work done reports, it is not practicable to establish the extent to which corrosion was causing deterioration

¹⁶⁵ Based on STELLAR DAISY's Noon Reports, after rounding the Cape of Good Hope while en route to Ilha Guaíba in ballast, the ship encountered 3-5 m seas from the south for eight of the ten days crossing the South Atlantic Ocean. The ship's GM₀ would likely have been between 15.615-17.101 m.

of the ship's structure. However, it is noted that under deck longitudinals in WBTs are prone to corrosion due to continuous presence of oxygen and, when the tank is filled, near continuous sloshing of seawater that can erode coatings and expose bare steel. Considering the number of corroded under deck longitudinals in the No. 2 P/S WBTs and No. 4 P/S WBTs that required renewal in 2012 and 2015, the fact that the under deck longitudinals could not be effectively assessed during in service inspections, the findings of the fleetwide inspection, and the susceptibility of under deck longitudinals to corrode, it is likely there was active corrosion impacting the under deck structure in the WBTs.

The condition of the centerline voids was determined by the ship's Master to be poor when these tanks were inspected in 2016. The stated reason was the reported practice of draining water that accumulated in the cargo hold bilges during loading into the centerline voids. However, it is noted that these tanks were coated, that iron entrained in any water drained into the voids from the cargo holds would have caused stains on the structural members, and that the attending KR surveyor assessed their condition as good when they were inspected in 2011, 2012, and 2015. Based on the above, it is not considered likely that there was significant corrosion in these voids.

Structural Repairs

Extensive repairs were made in the voids and WBTs within the cargo length in 2011, 2012, and 2015. Most of these repairs were accomplished by cropping the section of the damaged or corroded structural member and inserting new material. Although welding new steel to older steel is a standard practice, it can also introduce areas of stress and reduce the elasticity of the steel within the heat affected zone¹⁶⁶ of the weld. Areas of residual stress from welding cannot be detected during inspections or non-destructive testing. Although these stresses can be released without incident as the hull structure works over time, they can also cause the initiation of fatigue fractures in areas of high stress concentrations that can propagate into major fractures. These fractures can extend into structural members that were not welded when the repair was made.

Weld induced stresses are typically higher in high tensile strength steel than in mild steel, although they can be controlled using appropriate welding procedures and properly trained and qualified welders. Oversight, other than what is done by the shipyard's quality staff, of compliance with welding procedures and the use of properly trained and qualified welders is typically done by Classification Society surveyors.

While some of the repairs to the side shell longitudinals and under deck longitudinals involved inserts extending between frames, in many cases the inserts were much shorter. The result was that although the repaired structural members were stronger than when damaged, how the repairs were completed created many areas of concentrated stress. It also increased the number of areas where existing steel was made more prone to fractures.

With some exceptions, based on a comparison of the available survey reports and shipyard work done reports, many of the repairs that were made to STELLAR DAISY's hull structure in the years after the ship entered into service as a VLOC were not documented by a KR surveyor. Further, the repairs documented by the attending KR surveyor when STELLAR DAISY was in the shipyard in 2011, 2012, and 2015 were not based

¹⁶⁶ The heat affected zone is the portion of the metal that was not melted during welding, but whose mechanical properties or microstructure was altered when heated during welding.

on a failure analysis. Rather, they were based on the original design details. It is particularly noteworthy that a structural analysis of the cracked collar plates in way of the vertical stiffeners for the watertight bulkheads at frames Nos. 57 and 75 that were found within two years of STELLAR DAISY entering service as a VLOC was not conducted since the design details of these bulkheads were the same as those for the other watertight bulkheads within the cargo length. Although the repairs were examined and approved by the attending KR surveyor, the fact that a failure analysis was not conducted may have resulted in potential design defects not being identified and corrected. It is noted the failure analysis completed by KR in August 2016 of the damage to the transverse bulkhead at frame No. 65 determined the damage was isolated and not the result of a design defect. It is also noted the KR surveyor who attended STELLAR DAISY for the repairs of the transverse bulkhead at frame No. 65 required that intercostals be fitted between the vertical stiffeners to prevent tripping.

Multi-port Discharges

It is noted that the multi-port discharges conducted in 2016 and 2017 involved short coastal transits of approximately 25-30 NM. KR's analysis of the multi-port discharges conducted by STELLAR DAISY determined that portions of the hull structure would have been overstressed when the ship was partially loaded. This created the potential for localized damage in the areas of highest stress, which included the web of the swash bulkhead located at frame No. 79 in way of where the hopper plate is welded to the longitudinal bulkhead.

Summary

Although there were no open requirements issued by KR for repairs to STELLAR DAISY's hull when the ship got underway from the Ilha Guaíba Terminal on 26 March 2017, the strength of portions of the ship's structure was likely in a compromised condition due to fatigue, corrosion, and the repairs that had been made while the ship was in service as a VLOC. The ship might also have been damaged when the ship was conducting multi-port discharges. Further, because a failure analysis was not conducted to determine the cause of the damage observed when STELLAR DAISY was in the shipyard in 2011, 2012, and 2015, potential defects with the conversion design may not have been identified and corrected. It is probable that these factors contributed to compromising the integrity of STELLAR DAISY's hull structure and increased the potential for a major hull failure as the ship continued to trade.

Loss of Buoyancy and Foundering

STELLAR DAISY's EPIRB was first detected five minutes after the message was sent from the ship to the Superintendent reporting the ship was developing a rapid list to port due to flooding of No. 2 P WBT. This indicates the ship lost buoyancy and foundered very quickly.

The AB reported hearing a noise that sounded like an explosion and the Oiler stated he felt a rumble like an earthquake just as they became aware that STELLAR DAISY was starting to list to port. This was their first indication of a problem. As the ship continued to list, they both reported hearing loud cracks or explosions and feeling rumbles. What the AB and Oiler described hearing and feeling is consistent with a major structural failure.

With a loaded draft of 20.2 m, STELLAR DAISY's reserve buoyancy was approximately 169,425 MT. For the ship to lose buoyancy and founder one of three things would need to occur:

1. this quantity of seawater would have had to flood into the ship due to a shell plate failure at or below the waterline;
2. this amount of intact buoyancy would have to be lost due to a shell plate failure above the waterline; or
3. more likely, a combination of both.

For the ship to rapidly develop a 45° list to port, any failures of the shell plate would have been located primarily on the port side.

The total capacity of the port side WBTs and voids in the cargo length was 111,981 MT. Therefore, the flooding or loss of intact buoyancy had to extend to some combination of the cargo holds, the wing tanks on the starboard side, and the accommodation block.

Flooding of No. 2 P WBT

Based on the content of the message from STELLAR DAISY to the Superintendent, the low risk of cargo liquefaction, and the surviving crewmembers' report that the ship had been rolling normally, that they heard a noise that sounded like an explosion, and that they felt rumbles like an earthquake immediately before the ship started listing to port, the loss of buoyancy was most likely initiated by catastrophic flooding of the No. 2 P WBT. This indicates there likely was a failure of the shell plate at or below the load waterline in way of this tank rather than a slow ingress of water over time.¹⁶⁷

Due to material fatigue, corrosion, and areas of stress introduced as repairs were made in the years since the ship was converted to a VLOC, and the number of cracks in bottom and side longitudinals that were found on board other converted VLOCs managed by Polaris Shipping and classed by KR, there was a high potential for fatigue cracks to develop in the longitudinals and brackets as the hull worked in the sea conditions that were encountered between 29–31 March 2017.

The initiation and growth of fatigue cracks is a silent process and can occur at field stress levels lower than yield. Fatigue cracks grow a small amount with each stress cycle as a result of ductile tearing of the steel. The direction of growth is perpendicular to the tensile stress. Due to their small initial size, fatigue cracks can grow undetected by visual inspection. As the crack grows, the amount of undamaged material is decreased and is subjected to increasing levels of stress. Once the remaining undamaged material can no longer support the load, it fails in an instantaneous brittle fracture that can grow very rapidly. A large brittle fracture can sound like an explosion and

¹⁶⁷ The Administrator received information during the marine safety investigation into the loss of STELLAR DAISY suggesting that No. 2 P WBT might have flooded if both valves for the sea chest located in the tank were not fully closed when they were last operated. As previously noted, it would have been possible to discharge ballast water using gravitation until the ship's draft was greater than the depth of water in the tank. Based on the loading plan this likely occurred during pour eight of the 22 planned pours. If any appreciable quantity of water entered the tank through these valves, this would have likely been detected as the remaining ballast water was discharged during cargo loading. Further, the ingress of water into No. 2 P WBT after the ship departed from the Ilha Guaiba Terminal, could have been detected using the gauges in the Ballast Control Room and/or manual soundings. Lastly, a slow, continuous ingress of water into the tank would have induced a gradual port list and changed the ship's roll. Therefore, it is not considered likely that water ingress through these valves caused No. 2 P WBT to flood.

the resulting vibrations can be felt throughout a ship. A fatigue crack in an internal structural member, such as a web frame or a side or bottom longitudinal can potentially propagate into the shell plate.

Taking into consideration STELLAR DAISY’s repair history and the number of cracks in bottom longitudinals that were identified on other converted VLOCs, managed by Polaris Shipping and classed by KR, after the loss of STELLAR DAISY, the flooding of No. 2 P WBT likely was the result of one or more cracks in bottom longitudinals that either were not detected when the tank was last inspected in October 2016 or that developed after the inspection. As the crack, or cracks, grew, the pressure on the bottom shell as the ship rolled under the influence of the high GM₀ would have imposed additional stresses on the hull structure that could cause latent cracks in other bottom longitudinals to grow or for a fatigued bottom longitudinal to fail. As a result, the size of the crack would likely increase and potentially lead to a loss of shell plate and cause massive, uncontrollable flooding (see Figure 22).

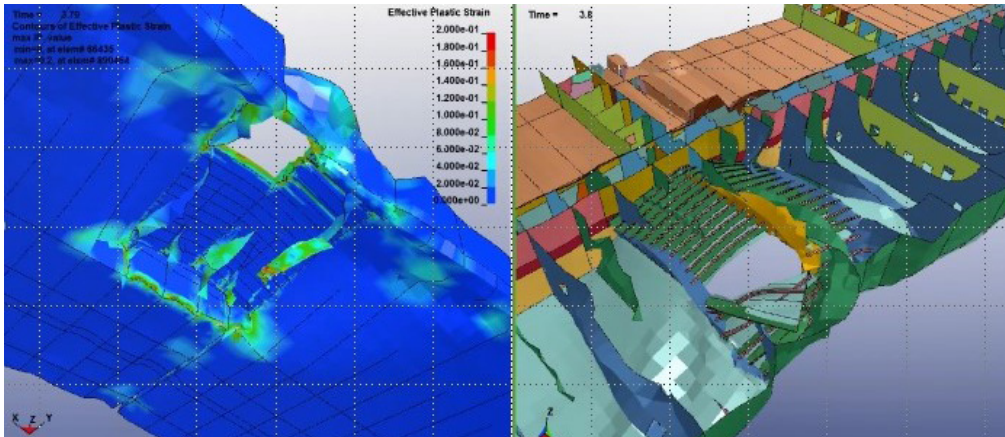

Figure 22: Graphic showing potential damage to the bottom plate and internal structure based on a transverse brittle fracture originating forward of the transverse bulkhead at frame No. 75. The hole in the bottom of No. 2 P WBT is approximately 15 m².

Based on the ship’s loaded draft of 20.3 m and a hole of 15 m² or more in way of No. 2 P WBT, STELLAR DAISY could have developed a port list of 7° and reached a condition of equilibrium in approximately two minutes. If the condition of equilibrium was upset, the tank potentially could have flooded to 95% of its total capacity of 23,493.9 m³ less than a minute later (see Table 8).

Table 8: Time to Flood No. 2 P WBT to Equilibrium and to 95% Capacity

Hole Size (m ²)	Flooding Rate (m ³ /min)	Time to Flood to Equilibrium (min)	Time to Flood to 95% Capacity (min)
5	3,643.1	5.0	6.1
10	7,286.3	2.5	3.1
15	10,929.4	1.7	2.0
20	14,572.6	1.3	1.5
25	18,215.72	1.0	1.2

Note: The flooding rate is based on a draft of 20.3 m. This rate would increase due to the change of draft as the tank flooded.

Although the damage stability criteria were met and neither the bending moment or shear force exceeded the allowed at-sea values when No. 2 P WBT was flooded to the point of equilibrium, KR's post-casualty structural analysis determined that flooding of this tank would likely have caused portions of the transverse structure between the hatch openings for Cargo Holds Nos. 2-5 to buckle (*see Figures 19 and 20*). This buckling would likely cause the cross deck between Cargo Holds Nos. 1 and 2, Nos. 2 and 3F, Nos. 3F and 3A, and Nos. 3A and 4 to collapse. It would also be expected to cause cracks to develop in the deck plate outside the line of hatch openings on both the port and starboard sides and deflection of the cargo hold hatches and coamings. The collapse of the cross deck, cracks in the deck and deflection of the hatch coamings would have resulted in the loss of intact buoyancy and the potential for down flooding of port side wing tanks and cargo holds.

The collapse of the cross deck and related damage, including some damage of the transverse bulkheads between the cargo holds would have resulted in increased stresses on the undamaged structure. This increased the potential for very rapid progressive structural failure. It would have also resulted in the loss of intact buoyancy and the potential for down flooding of port side wing tanks and cargo holds. The resulting additional loss of buoyancy would be expected to upset the condition of equilibrium and cause No. 2 P WBT to flood further.

For STELLAR DAISY to rapidly lose buoyancy, more spaces than the No. 2 P WBT had to also flood and lose intact buoyancy almost simultaneously. As previously noted, the rapid development of a 45° list to port required that any failures of the shell plate would have been located primarily on the port side. Taking into consideration the repair history of the port side wing tanks and that in normal service the forward portion of hull is not subject to high bending moments or shear forces, it is likely that No. 3 P WBT flooded almost simultaneously with No. 2 P WBT.

Flooding of the No. 3 P WBT

For the No. 3 P WBT to flood simultaneously, or almost simultaneously, with the No. 2 P WBT, it would have been necessary for there to be a failure of the hull at or below the waterline in way of the No. 3 P WBT, or for there to be a total collapse of the transverse bulkhead between these tanks.

As previously stated, 38 of the 58 cracks that were identified in bottom longitudinals on converted VLOCs, managed by Polaris Shipping and classed by KR, were in way of a transverse bulkhead. If one or more of these cracks propagated into the bottom plate, it would be possible for a resulting brittle fracture to create a hole in both tanks. The additional stresses on the ship's structure as No. 2 P WBT flooded could also lead to progressive failure of the bottom longitudinals at the forward end of No. 3 P WBT and a corresponding failure of the bottom plate (*see Figure 22*).

Based on the ship's loaded draft of 20.3 m and a hole of 15 m² or more, the No. 3 P WBT could have flooded to 95% of its total capacity of 29,332.5 m³ in less than three minutes (*see Table 9*). This is consistent with the statements of the two surviving crewmembers indicating that the list to port rapidly increased.

Table 9: Time to Flood No. 3 P WBT to 95% Capacity

Hole Size (m ²)	Flooding Rate (m ³ /min)	Time to Flood (min)
5	5,946.1	7.6
10	11,892.3	3.8
15	17,838.4	2.5
20	23,784.6	1.9
25	29,730.7	1.5

Note: The flooding rate is based on a draft of 20.3 m. The flooding rate would increase due to the change of draft as the tank flooded.

Simultaneous, or almost simultaneous, flooding of Nos. 2 and 3 P WBTs could have caused STELLAR DAISY to develop a list of approximately 18° to port within about two to three minutes. This would have submerged the outboard portion of the main deck and air vents for No. 4 P WBT. The forward draft would have increased to 26.59 m and the trim by the bow would have increased to 6.18 m. Considering the sea conditions, this would likely have resulted in down flooding of port side wing tanks through any cracks that had opened in the deck due to the collapse of the cross decks and cause the magnitude of the list to continuously increase. As the list increased, the potential for down flooding of the cargo holds through the collapsed cross deck and deflected hatch covers and coamings would have also increased.

Taking into consideration the statements of the surviving AB and Oiler regarding how rapidly the list increased, the very short period of time between when they heard the first explosive sounds and felt the earthquake like rumble and when they were both in the water, the flooding of Nos. 2 and 3 P WBTs combined with down flooding of the port side wing tanks and cargo holds would not have been enough for STELLAR DAISY to develop a 45° list and founder so quickly. This indicates that there were additional progressive structural failures on the ship’s port side.

Failure of the Longitudinal Bulkheads

The pressure of cargo at any given point on the longitudinal bulkhead is a function of the angle of the bulkhead to the waterline, the height of the cargo and the density of the cargo. The implication is that the pressure of the cargo on the port side longitudinal bulkhead for each of the six cargo holds would have increased as the list increased. Given the existing sea conditions, there would also have been transient increases in pressure as the ship rolled.

Assuming the longitudinal bulkhead and its supporting structure was not damaged as a result of flooding of Nos. 2 and 3 P WBTs and that the cargo had not shifted, the calculated cargo pressures in way of where the hopper plate landed exceeded the minimum yield pressure as the list approached 25°.168 It is noted that the pressure on the cargo hold could have exceeded yield sooner for short periods as the ship rolled.

Because the pressure would have increased on the port side longitudinal bulkhead for each of the ship’s six cargo holds, it was possible that one or more of these bulkheads failed initially. A failure of one of these bulkheads

168 At a list of 25° the calculated pressure using the guidance in the KR Rules for Steel Ships, Part 3, Annex 3-2, on the longitudinal bulkhead was 231 N/mm² at longitudinal No. 24 and 244 N/mm² at longitudinal No. 25, which is where the hopper plate lands on the bulkhead. The yield value was 235 N/mm².

would permit cargo to flow from the cargo hold into the adjacent port side wing tank. This would shift KG to port and cause the list to continue to rapidly increase. If a longitudinal bulkhead in way of a breached wing tank failed, the adjacent cargo hold would begin to flood.

As the port list continued to rapidly increase, the potential for cargo to shift to port also increased. This would have increased the pressure on the longitudinal bulkheads and the potential that all the port side longitudinal bulkheads would fail. This would have accelerated the list to port as cargo flowed from the cargo holds into the port side wing tanks. It would also have further contributed to the loss of buoyancy.

Flooding of Cargo Holds

Down flooding of the cargo holds, particularly those forward of amidships, due to hatch covers losing their watertight integrity and through any fractures that might have opened in the deck plate as the No. 2 P WBT flooded was possible. Based on the information available, the likelihood of significant down flooding of one or more of the forward cargo holds is considered low, since the 7° port list and approximately 3 m trim by the bow due to flooding of the No. 2 P WBT would not have been enough to submerge the deck.

The potential for down flooding of the cargo holds increased with both the Nos. 2 and 3 P WBTs flooded and the deck submerged. The failure of transverse bulkheads between the cargo holds due to buckling would also have increased the potential for progressive flooding of cargo holds.

Flooding of the cargo holds due to failure of a longitudinal bulkhead in way of a breached wing tank, progressive flooding due to a failed transverse bulkhead, or as a result of down flooding would have contributed to the loss of buoyancy. However, because the cargo holds were inboard of the wing tanks, flooding of the cargo holds would not have contributed significantly to the ship's port side list.

The cargo could have begun to liquefy as the cargo holds flooded. As previously stated, liquefaction would likely have caused additional structural failures. However, due to how fast STELLAR DAISY lost buoyancy and foundered, liquefaction of cargo as the cargo holds flooded was not likely a significant factor in the loss of the ship.

Hull Failure in Way of Frames Nos. 48-50 and Breach of FOTs

The surviving Oiler reported he was washed overboard by a wave of water and bunker oil that came from forward of the accommodations. For this to occur, it was necessary for there to be a loss of structural integrity of one or more of the ship's FOTs and a loss of watertight integrity of the deck and side shell in way of frames Nos. 48-50 (*see Figure 11*).

Based on the post-casualty FEA conducted by KR, flooding of the No. 2 P WBT would likely have imposed sufficient torsion on the hull to cause the forward bulkhead of the port FOT to fail. The torsion created by flooding of both the Nos. 2 and 3 P WBTs would likely have also caused the deck in way of the starboard FOT to fail. It is likely that the side shell in way of frames Nos. 48-50 would also have failed due to the torsion that was imposed on the hull by the flooding of the No. 2 P WBT and the No. 3 P WBT. This

would have enabled bunker oil to mix with sea water as described by the Oiler. The failing steel plate would have generated the sounds the AB and the Oiler reported hearing after the initial explosion-like noise and an earthquake-like feeling.

A loss of watertight integrity in way of frames Nos. 48-50 would also have resulted in the rapid flooding of the No. 6 P Void and the No. 5 Cargo Hold. This would have imposed additional stresses on the hull that likely would have resulted in flooding of the No. 5 P Void, which would further contribute to the loss of buoyancy and cause the port list to continue increasing.

Summary

Based on the information available, a possible sequence of events leading to the loss of buoyancy and foundering of STELLAR DAISY within approximately five minutes was:

1. structural failures in the No. 2 P WBT and simultaneous, or near simultaneous, structural failures in the No. 3 P WBT resulting in a breach of the bottom plate and very rapid, uncontrolled flooding of both tanks;
2. rapid, progressive structural failures of the transverse structure, collapse of the cross deck between multiple cargo hatches and cracks in the main deck resulting in down flooding of port side wing tanks and cargo holds;
3. failure of longitudinal bulkheads resulting in cargo spilling into the port side wing tanks and flooding of cargo holds adjacent to flooded wing tanks;
4. flooding of the Nos. 5 and 6 P Voids due to failures of the deck and side shell between frames Nos. 48-50; and
5. flooding of the accommodation block.

It is expected that additional structural damage would have occurred as STELLAR DAISY foundered.

Human Factors

Although the Master, C/O, and C/E were all on their first contract with Polaris Shipping, they were all experienced seafarers and, more than likely, would have been familiar with their roles and responsibilities.

The Master and C/O both had extensive experience on board bulk carriers and would have been familiar with the risks associated with different bulk cargoes, including iron ore fines. Further, the Master had the benefit of the review of the IMSBC Code requirements for loading and transporting cargoes commonly transported by ships in Polaris Shipping's managed fleet. Based on the information that is available, there is no indication that decisions they made regarding cargo loading or handling contributed to the loss of STELLAR DAISY.

Although the WBTs and voids in the cargo length were inspected as part of the fourth of the Master's internal structural inspections conducted in 2016 before the C/O and C/E joined STELLAR DAISY on 11 November 2016, the C/O and C/E were on board when the APT was inspected. While it cannot be confirmed, as the next most senior officers on board, it is likely they had some awareness of the documented condition of the tanks in the cargo length. Although it is not known if an internal structural inspection had been completed during the first

quarter of 2017, the Master, who joined the ship on 21 February 2017, was made aware of the ship's structural condition and the responsibility to complete inspections and submit these reports when he was briefed in Polaris Shipping's offices prior to joining the ship.

As previously noted, Polaris Shipping's SMS did not include guidance for Masters about changing course and/or speed when encountering heavy weather. However, changing course and/or speed based on the existing weather conditions is inherent in the Master's over-riding responsibility for the safety of the ship, crew, and cargo.¹⁶⁹

As experienced seafarers, the Master and C/O would have been familiar with general shipboard emergency procedures, including those for abandoning ship. Based on the information available, it is not known why the Master ordered the ship's crew to the Bridge rather than to their assigned life boat stations. Noting it was five minutes between when the message was sent to the ship's Superintendent reporting that the No. 2 P WBT was flooding and when the EPIRB was first detected, it is possible the Master and C/O did not immediately recognize how quickly the initial list to port would develop into a loss of the ship. Considering that the surviving AB had been on the Bridge, it cannot be concluded that the Master's decision to muster the crew on the Bridge contributed to the loss of 22 of the ship's crew. Also, it is not known if any of the crewmembers who were on the Bridge followed the surviving AB when he entered the water from the port bridge wing.

Based on the information available, there is no indication that the loss of STELLAR DAISY was related to the two ABs not holding documents issued by the Administrator for service as AS-Ds.

Lifesaving Equipment

The damage sustained by the Nos. 1 and 2 life boats indicates that both were torn free from their respective davits as STELLAR DAISY sank (*see Figure 14*). Given how quickly the ship lost buoyancy, it is not considered likely that the crew would have been able to enter and successfully launch the life boats, even if they had been directed to immediately proceed to their life boat stations after it was determined that the No. 2 P WBT was flooding.¹⁷⁰ The fact that the life boats were not launched is not considered to have contributed to the loss of 22 of STELLAR DAISY's crew.

Although the rapid increase of the ship's list prevented the Oiler and Bosun from successfully launching a life raft, three of the four life rafts that were stowed aft are known to have floated free as required.¹⁷¹ The aggregate capacity of the two life rafts found floating right side up was 30 persons, which was sufficient to accommodate the 24 persons who were on board STELLAR DAISY for at least 30 days. Although life rafts are designed to inflate right side up, they will occasionally capsize. However, it would have been possible for the survivors to, if necessary, right a capsized life raft. The performance of the life rafts is not considered to have contributed to the loss of 22 of STELLAR DAISY's crew.

169 See the IMO ISM Code (Resolution A.741(18) as amended), paragraph 5.2. It is noted that after the loss of STELLAR DAISY, Polaris Shipping amended its SMS to include guidance for Masters to change course and/or speed to ensure the ship's safety.

170 SOLAS regulation III/13.1 requires that a life boat can be launched when a ship is listed up to 20° to either port or starboard and prepared for embarkation and launched in less than five minutes by two crew members. It is also noted that the period of time between when the message was sent to the ship's Superintendent that the No. 2 P WBT was flooding and when the EPIRB was first detected was five minutes. However, given the time needed for the Master to assess the situation, to sound the alarm, and for the crew to proceed to their muster stations, the crew likely would not have had five minutes to prepare and launch the life boats before the list exceeded 20°. A similar analysis would apply if the ship had been fitted with a free fall life boat during the conversion.

171 As previously noted, it is not known what happened to the fourth life raft.

The fact that two of the three life rafts that are known to have floated free were floating right side up, permitted the two surviving crewmembers to get out of the water and conserve their energy. Considering that the size of a life raft makes it significantly easier to see than a person floating in the water, the likelihood of the two surviving crewmembers being rescued was increased significantly because they were able to enter one of the ship's life rafts.

It is not known if the EPIRB was released by a member of STELLAR DAISY's crew and manually activated or if it floated free and automatically activated. Regardless, the EPIRB functioned as intended and was vital for ensuring that the search and rescue system was quickly activated. Considering STELLAR DAISY's position when the ship foundered (*see Figure 12*), the proper functioning of the EPIRB was vital for the successful rescue of the two surviving crewmembers.

Polaris Shipping

Polaris Shipping had an effective system in place for ensuring Masters of ships in their managed fleet were aware of how to identify and manage risks associated with cargo liquefaction. This included reviewing SMS procedures and IMSBC Code requirements that should be followed when determining whether a cargo is safe to load during briefings in the company's office before Masters joined their ship. It also included monitoring and recording soundings of the cargo hold bilges twice a day when on a laden voyage.

Polaris Shipping was aware that regularly carrying high density cargoes could result in structural damage. To monitor the structural condition of the ships in Polaris Shipping's managed fleet, Masters were required to conduct an inspection of all cargo holds, WBTs, and voids once each quarter. Due to the size of STELLAR DAISY's WBTs and voids, these inspections are general assessments rather than detailed inspections.

The way the damage to the watertight bulkhead at frame No. 65 was addressed indicates Polaris Shipping may not have had procedures in place to effectively assess and manage structural damage that potentially affected the ship's seaworthiness. Although a Superintendent examined the damage after it was reported by the ship's Master, Polaris Shipping did not initiate a detailed structural failure assessment. Rather, in consultation with the Master, it allowed the ship to complete an additional voyage without imposing any restrictions on the amount of cargo carried or weather conditions.

In addition, Polaris Shipping did not report the damage to KR until just before taking the ship to the shipyard for repairs. Further, other than the damage to the forepeak when STELLAR DAISY contacted the pier while berthing in Gwangyang on 11 June 2012, the Administrator does not have on record any reports of damage to the ship's structure.

It is noted that the Administrator's inspections of other ships in Polaris Shipping's managed fleet and KR classed that were registered in the Republic of the Marshall Islands following the loss of STELLAR DAISY found that structural repairs that had been made in the shipyard or as voyage repairs were generally: not based on any documented structural analysis; completed without a detailed repair plan; and commonly accomplished using short inserts. This indicates Polaris Shipping may not have had effective procedures in place to properly assess and address structural damage.

The cargo hold bilge wells were fitted with drains that made it possible to drain water that accumulated in these wells into the centerline voids. Since the drains were not included on the drawing for the bilge system, it is likely they were fitted sometime after STELLAR DAISY entered service as a VLOC. Considering that the Master's quarterly inspection reports for 2016 stated that water from the cargo holds was drained into the centerline voids and that these reports were reviewed by the ship's Superintendent, Polaris Shipping was aware that this was occurring.

KR

Based on the records available to the Administrator, KR's review and approval of the conversion design was based on the assumption that all of the scantlings, including those from when the ship was constructed as a VLCC in 1993, were as original and did not take into account material fatigue. The basis for this assumption was that the FEA, which was conducted in accordance with the requirements of the KR Rules for Steel Ships, took into consideration allowable stress, corrosion, and stresses due to local notch effect.

Although KR did conduct a failure analysis of the damage to the transverse bulkhead at frame No. 65, it did not conduct a failure analysis after an extensive number of cracks were identified and repaired when the ship was in drydock in 2011, within two years after the conversion was completed. As a result, potential weaknesses with design details were not identified. This is an indication that KR's monitoring and assessment of the ship's structural integrity was not as effective as it might have been.

As noted previously, the official report completed by the KR surveyors who attended STELLAR DAISY in dry dock in 2015 did not document the structural repairs that were completed. However, notes prepared by the attending KR surveyor and drawings that were used by the attending surveyor to confirm and check the repairs that were completed were provided by KR to the Administrator during the Administrator's investigation. These documents indicate that the steel work reported on the shipyard's work done report was examined and verified by the attending surveyor. This is an indication of ineffective oversight by KR of its regional offices and surveyors regarding documenting required repairs.

KR is authorized to serve as an RO on behalf of the Administrator.¹⁷² The 2016 RO Agreement between the Administrator and KR requires that KR immediately inform the Administrator of, among other things, "any dangerous occurrences, accidents, machinery or structural breakdowns, or failures that they are aware of on a Vessel."¹⁷³ KR did not inform the Administrator of the damage to frame No. 65 in 2016.¹⁷⁴

Flag State

Although it was noted during the flag State registration vetting process that STELLAR DAISY had been converted from a VLOC to a VLCC, neither a pre-registration inspection nor technical information regarding

¹⁷² This authorization is permitted by SOLAS regulation XI-1/1 and an agreement is in place as required by the IMO Code for Recognized Organizations (RO Code) (IMO Resolution MSC.349(92)). The RO Code entered into force on 1 January 2015.

¹⁷³ 2016 RO Agreement, Annex II, section 8.

¹⁷⁴ It is noted that KR also did not inform the Administrator of the damage to the forepeak in 2012. The damage should have been reported in accordance with the RO Agreement that was in place between the Administrator and KR at that time.

the conversion design were required prior to registering the ship in the Republic of the Marshall Islands. This was consistent with the vetting requirements that were in place when STELLAR DAISY was registered in 2009.

Annual flag State safety inspections were conducted to verify compliance with Republic of the Marshall Islands law and international conventions. These inspections included, among other things, a visual assessment of the external portions of the ship's hull and deck. Although such assessments provide a general indication of the condition of a ship's hull, they do not make it possible to assess the condition of the internal structural members of WBTs or voids. When warranted, special inspections are conducted to assess conditions not covered by an annual safety inspection, such as internal structural conditions. Prior to 31 March 2017, the Administrator had not received any information indicating that a special inspection of STELLAR DAISY may have been warranted.¹⁷⁵

IMO Requirements

SOLAS regulations XII/4 and 5 address the ability of a ship designed to carry solid bulk cargoes with a density of 1,000 kg/m³ and above to withstand flooding of any one cargo hold in all loading conditions. Both regulations were applicable to STELLAR DAISY. Based on the UI of SOLAS regulations XII/4.2 and 5.2 in MSC/Circ.1178, only Cargo Hold No. 1 needed to be considered flooded to demonstrate compliance with these regulations since this was the only hold that had a longitudinal bulkhead located within the specified dimension inboard from the ship's side. Neither of these regulations required that the ship's stability or strength be evaluated in the event the wing tanks in way of Cargo Holds Nos. 2-5 were flooded while the ship was in a loaded condition.

For STELLAR DAISY to be assigned a reduced freeboard, it was necessary to demonstrate that the ship met the damage stability criteria contained in ICLL 1966 as amended by the Protocol of 1988, regulation 27(12). As previously noted, seven of the ten damage conditions that were evaluated to demonstrate compliance with these requirements were based on flooding of wing tanks in the cargo length. Of these seven, one included flooding of Cargo Hold No. 1, No. 1 S Void, and the No. 1 C Void.

Based on the damage stability information approved by KR, taking into consideration the requirements of ICLL 1966 as amended by the Protocol of 1988, regulation 27(12), STELLAR DAISY should have been able to remain afloat if any one of the wing tanks had been flooded. Further, KR determined that the ship complied with SOLAS regulation XII/4 based on the approval of the damage stability information.

Taking MSC/Circ.1178 into consideration, STELLAR DAISY was required by SOLAS regulation XII/5.2 to have sufficient strength to withstand the flooding of Cargo Hold No.1 in all loading and ballast conditions. As stated previously, KR determined at the time of conversion that the ship was in compliance with this regulation. Neither SOLAS regulation XII/5 nor the criteria for a reduced freeboard in the ICLL 1966 as amended by the Protocol of 1988, regulation 27 requires that bulk carriers of 150 m or more in length of double-side skin construction with longitudinal bulkheads that are located more than B/5 or 11.5 m, whichever is less, from the ship's side to have adequate strength to withstand flooding of any one of the wing tanks within the cargo length.

¹⁷⁵ The Administrator's primary source of information regarding the condition of a ship's internal structural condition is the RO. See 2016 RO Agreement, Annex II.

It is noted that KR's post-casualty structural analysis determined that the bending moment and shear force were within the allowed at-sea values when STELLAR DAISY's No. 2 P WBT was flooded. However, it also determined that flooding of this tank while STELLAR DAISY was fully laden in heavy weather would have caused significant progressive structural damage. While noting the importance of ensuring that a bulk carrier can remain afloat when a cargo hold is flooded, the benefits of SOLAS regulations XII/4 and 5 are limited with respect to ensuring that ships, such as STELLAR DAISY, that have parts of the longitudinal bulkhead more than B/5 or 11.5 m, whichever is less, inboard from the ship's side at a right angle to the centerline at the summer load line can withstand the flooding of any one wing tank in all loading and ballast conditions. This is a potential regulatory gap.

The ESP Code and the 2011 ESP Code established minimum, uniform, and mandatory survey requirements for bulk carriers and tankers. As previously noted, these requirements were incorporated into KR's Rules for Steel Ships. Both the ESP Code and the 2011 ESP Code require that WBTs on bulk carriers be inspected annually if the condition of the coatings is poor.¹⁷⁶ This is in contrast with the current requirements for tankers. WBTs on tankers are required to be inspected annually if the condition of the coatings is less than good.¹⁷⁷ While acknowledging the environmental consequences of a major oil spill are significantly different than the environmental consequences associated with the loss of a bulk cargo, the potential loss of life associated with the loss of a tanker or a bulk carrier is the same. The safety of bulk carriers could be improved by aligning the inspection requirements due to coating breakdown for WBTs with those for tankers.

Both the ESP Code and the 2011 ESP Code require that voids within the cargo length of bulk carriers be inspected once every five years.¹⁷⁸ They also require that "the survey extent of ballast tanks converted to void spaces should be specially considered in relation to the requirements for ballast tanks."¹⁷⁹ It is noted that the No. 5 P/S Voids were converted from WBTs after STELLAR DAISY was in service as a VLOC for just over two years. However, based on the available survey reports it is not possible to determine what, if any, special consideration was given as required by the ESP Code and the 2011 Code when determining the survey extent of these tanks. Further, considering that the voids within the cargo length of STELLAR DAISY were not required to be coated or provided with other means of corrosion protection, the structural members in these voids were potentially subject to corrosion, which if not detected and corrected could lead to structural failure.

Although it is not considered likely that cargo liquefaction initiated the loss of STELLAR DAISY, it is noted that the IMSBC Code permits a lab directly affiliated with the shipper to establish the TML and MC of a Group A cargo provided the lab is certified by the competent authority for the loading port rather than requiring

176 ESP Code, Annex A, Part A, paragraph 2.3.1 and Part B, paragraph 2.3.1; 2011 ESP Code, Annex A, Part A, paragraph 2.3.1 and Part B, paragraph 2.3.1.

177 2011 ESP Code, Annex B, Part A, paragraph 4.2.3.4 and part B paragraph 4.2.3.4. The ESP Code originally required annual inspections of WBTs on tankers only if the condition of the coatings was poor.

178 ESP Code, as amended by IMO Resolution MSC.261(84), Annex A, paragraph 2.1.4; 2011 ESP Code, Annex A, Part A, paragraph 2.1.4 and Part B, paragraph 2.1.4. Voids that are adjacent to cargo oil tanks, decks and the outer hull of oil tankers are also required to be inspected once every five years. See ESP Code, Annex B, paragraph 2.1.4; 2011 ESP Code, Annex B, Part A, paragraph 2.1.4 and Part B, paragraph 2.1.4.

179 ESP Code, as amended by IMO Resolution MSC.261(84), Annex A, paragraph 2.1.7; 2011 ESP Code, Annex A, Part A, paragraph 2.1.6 and Part B, paragraph 2.1.6. It is noted that the phrase "specially considered" is not defined in the ESP Code or 2011 ESP Code. For hull surveys of bulk carriers, including bulk carriers, IACS has defined "special consideration" to mean: "Special consideration or specially considered (in connection with close-up surveys and thickness measurements) means sufficient close-up inspection and thickness measurements are to be taken to confirm the actual average condition of the structure under the coating." See IACS UR Z10.2, revision 28 (March 2011) and Z10.5, revision 10 (March 2011). These URs are applicable to single skin and double skin bulk carriers. This definition has not been changed in subsequent revisions of Z10.2 and Z10.5.

independent, third-party testing.¹⁸⁰ As noted previously, Vale does not permit ship's Masters or representatives to examine the cargo stockpiles or obtain cargo samples for independent testing prior to loading. Given the high potential consequences when a cargo does liquefy, independent testing to determine whether a cargo subject to liquefaction is safe to load could contribute to improving bulk carrier safety.

Ensuring that Group A cargoes are safe to load is critical for preventing the potential for liquefaction incidents and of utmost importance for improving bulk carrier safety. However, just as SOLAS includes regulations intended to prevent fires, SOLAS also includes regulations intended to help ensure that ships and their crew can survive when a fire does occur. Although the IMSBC Code, section 7.3 includes some provisions for ships specially constructed or fitted to limit cargo shift, neither the additional safety measures for bulk carriers in SOLAS Chapter XII nor the IMSBC Code require that a bulk carrier has adequate intact stability and strength to remain afloat in a satisfactory condition of equilibrium in the event a cargo does liquefy.

¹⁸⁰ It is noted that this provision also includes Group B cargoes.

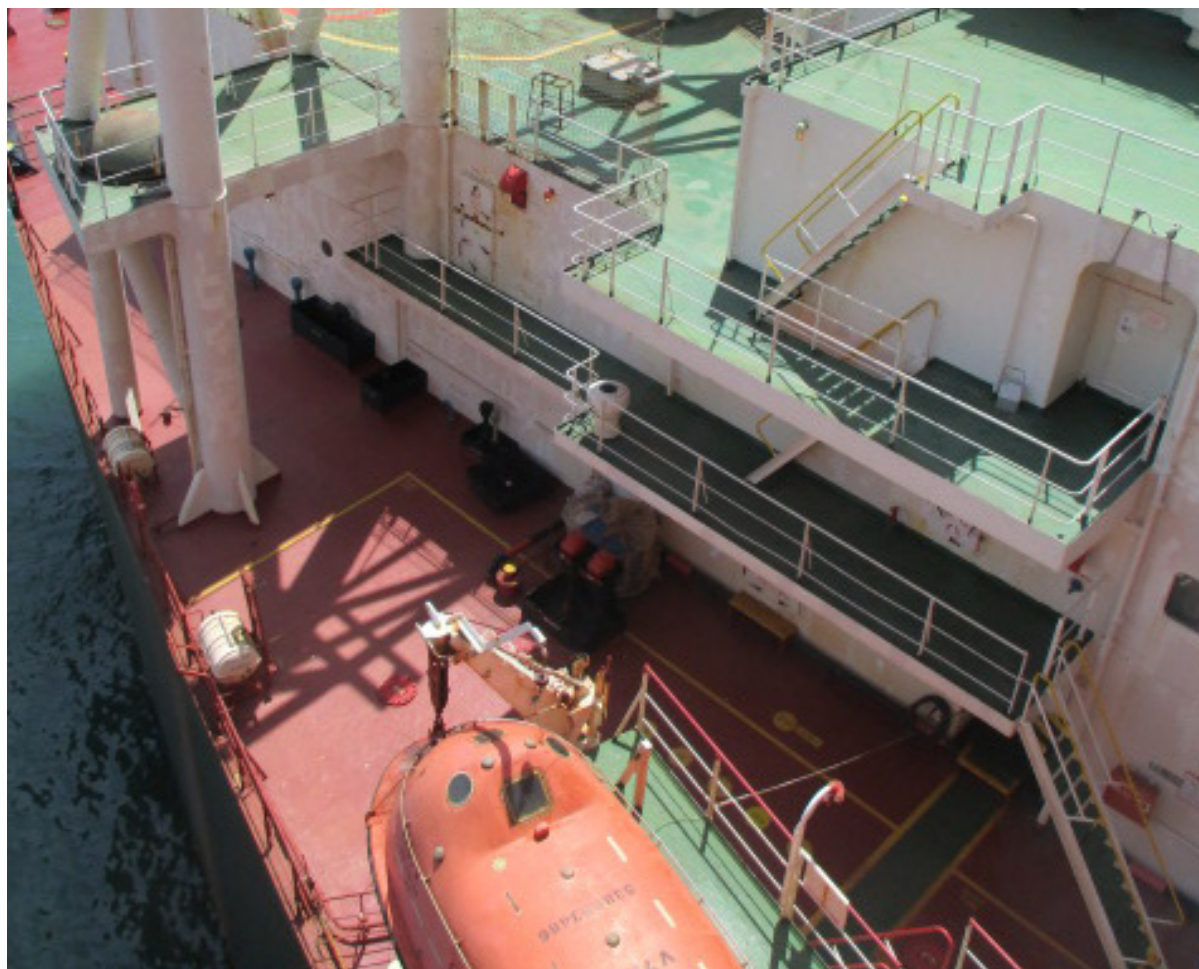

PART 4: CONCLUSIONS

The following Conclusions are made based on the above Findings of Fact and Analysis and shall in no way create a presumption of blame or apportion liability.

1. The likely direct cause of STELLAR DAISY foundering in the South Atlantic Ocean on 31 March 2017 was a rapid list to port following a catastrophic structural failure of the ship's hull that resulted in a loss of buoyancy and uncontrolled flooding. As a result, the ship sank in approximately 3,400-3,600 m of water and is a total loss. The structural failure and flooding most likely began in the No. 2 P WBT and progressed rapidly to include No. 3 P WBT. The exact sequence of the hull failure and flooding is not known but was likely as described in the Analysis section. The hull failure was likely due to a combination of factors, including the likelihood that the ship's structural strength had been compromised over time due to material fatigue, corrosion, unidentified structural defects, multi-port loading, and the forces imposed on the hull as a result of the weather conditions STELLAR DAISY encountered between 29–31 March 2017.

2. The 22 crewmembers who were lost when STELLAR DAISY sank are missing at sea and are presumed deceased.
3. The likely causal factors include:
 - (a) the large WBTs increased the potential for a major structural failure and loss of buoyancy in the event that a WBT flooded when the ship was in a laden condition;
 - (b) SOLAS regulation XII/5 does not require an assessment to ensure bulk carriers of 150 m or more in length of double-side skin construction designed to carry solid bulk cargoes of 1,000 kg/m³ and above that have parts of the longitudinal bulkhead more than B/5 or 11.5 m, whichever is less, inboard from the ship's side at a right angle to the center line at the summer load line can withstand the flooding of any one wing tank in all loading and ballast conditions; and
 - (c) ineffective assessments of structural damage identified when STELLAR DAISY was dry docked in 2011, 2012, and 2015 to determine the cause of the structural damage, identify potential defects with the conversion design, or require the development of appropriate repair plans.
4. Potential contributing factors include:
 - (a) inconsistent compliance by Polaris Shipping with both KR's requirements for reporting structural defects and the Administrator's requirements for reporting marine incidents and marine casualties;
 - (b) ineffective enforcement by KR of the Classification Society's rules to ensure Polaris Shipping was reporting identified damage;
 - (c) non-compliance by KR with the requirements in the 2016 RO Agreement to notify the Administrator of, among other things, "any dangerous occurrences, accidents, machinery or structural breakdowns, or failures that they are aware of on a Vessel;"¹⁸¹ and
 - (d) the less stringent requirements of the 2011 ESP Code regarding the schedule of annual inspections of WBTs on bulk carriers due to deterioration of coatings when compared to those for WBTs on tankers.
5. Additional issues that did not contribute to the sinking of STELLAR DAISY include:
 - (a) cargo hold bilge water was occasionally drained into the centerline voids;
 - (b) the Administrator's vetting process at the time of registration was not effective in identifying and assessing potential safety risks of a VLCC that had undergone a major conversion to a VLCC;
 - (c) neither the additional safety measures for bulk carriers in SOLAS Chapter XII nor the IMSBC Code require an assessment to ensure that a bulk carrier has sufficient stability and strength in an intact condition to withstand the liquefaction of a bulk solid cargo in one or more cargo holds;
 - (d) the provisions of the IMSBC Code that allow a shipper to determine the TML and MC of a Group A cargo could be detrimental to bulk carrier safety;
 - (e) ineffective oversight by KR of regional offices and surveyors regarding documenting required repairs; and
 - (f) two of the deck ratings did not hold proper Republic of the Marshall Islands seafarer documents.

¹⁸¹ 2016 RO Agreement, Annex II, section 8.



PART 5: PREVENTATIVE ACTIONS

Polaris Shipping has taken the following Preventative Actions:

1. revised the SMS to include a statement that Masters have the authority to alter course or reduce speed without consulting with Polaris Shipping when necessary to avoid injuries or damage to the ship;
2. conducted, in coordination with KR and LR a comprehensive structural analysis and close-up inspections of the converted VLOCs under its management to identify potential structural defects in order to enhance structural integrity and to develop and make modifications on a prioritized basis;
3. inspected the other VLOCs under its management to determine if other ships were fitted with an improper means of draining cargo hold bilge wells directly into the centerline voids and removed any improper drains that were identified;
4. initiated a full review of their SMS by a third-party auditor;

5. established an open reporting system;¹⁸²
6. reinforced its staff by hiring a technical consultant and hull specialist;
7. implementation, as appropriate, of internationally recognized standards throughout the organization;
8. achieved OHSAS 18001 certification;¹⁸³
9. conducted a RightShip Bulk Management Self Assessment management review;
10. implemented an enhanced hull maintenance training program for shipboard and shore staff; and
11. implemented the “Polaris 10 Safety Golden Rules.”¹⁸⁴

The Administrator concurs with these actions.

KR has taken the following Preventative Actions:

1. conducted conditional assessment surveys, which included close-up inspections, of the 18 converted VLOCs classed by KR that were managed by Polaris Shipping;¹⁸⁵
2. conducted special inspections in coordination with experts appointed by the Republic of Korea of seven of the converted VLOCs managed by Polaris Shipping;
3. issued circulars to KR surveyors addressing survey report writing;
4. issued a circular and conducted training for KR personnel responsible for reviewing and approving survey reports; and
5. conducted seminars for ship owners and KR surveyors addressing the characteristics of converted VLOCs and structural failures.

The Administrator concurs with these actions.

The Administrator has taken the following Preventative Actions:

1. has actively monitored KR’s assessments of structural damage found on the 11 converted Polaris Shipping managed VLOCs registered in the Republic of the Marshall Islands and has reviewed and, when necessary, required revisions of proposed repairs;
2. has met with KR to, among other things, review the requirements in the 2016 RO Agreement and the Administrator’s expectations for reporting dangerous occurrences, accidents, machinery or structural breakdowns, or failures that KR is aware of on a ship;

182 Open reporting systems are used by ship managers to provide a means for anonymous internal reporting of non-compliance with the company’s policies and procedures and other ship safety and environmental protection requirements.

183 OHSAS 18001 is the International Occupational Health and Safety Management Standard developed by the British Standards Institution.

184 These relate to safe work practices and include, among other things, use of Toolbox Talk and work permits to improve pre-task hazard assessments, and a system of pre-checks for tools and equipment.

185 As stated previously, the Administrator attended the surveys conducted on board the ships that were registered in the Republic of the Marshall Islands.

3. has met regularly with Polaris Shipping to review the results of its assessments of structural damage found on Polaris Shipping's managed VLOCs that are registered in the Republic of the Marshall Islands and repairs proposed by Polaris Shipping; and
4. in addition to flag State annual safety inspections, as part of the implementation of the 2016 RO Agreement, the Administrator is conducting oversight inspections of the 11 converted VLOCs registered in the Republic of the Marshall Islands that are classed by KR in conjunction with attendance by the assigned Classification Society surveyors.



PART 6: RECOMMENDATIONS

The following Recommendations are based on the above Conclusions and in consideration of the Preventative Actions taken.

1. It is recommended that Polaris Shipping:
 - (a) ensure that the reporting procedures in its SMS are consistent and in compliance with those of the ship's Classification Society and the Administrator;
 - (b) ensure shore staff and sea staff comply fully with the reporting procedures in its SMS, especially with respect to damage or failures that potentially impact structural integrity;
 - (c) as part of the familiarization briefing for on-signing Masters:
 - (i) review how changes of course or speed may reduce forces imposed on the ship's structure; and
 - (ii) review emergency response procedures when a ship develops a sudden list;
 - (d) in coordination with the RO that issued the ship's statutory certificates, develop and implement a procedure for the ships in their fleet for managing cargo hold bilge water that accumulates during

cargo loading or discharge that is consistent with applicable international and port State regulations and that does not involve draining such water into void spaces; and

- (e) review and, as deemed appropriate, revise the procedures for assigning officers and ratings to:
 - (i) reduce the potential for a Master and C/O who are both on their first contract with the company to be assigned to the same ship;
 - (ii) reduce the potential for a Master and C/E who are both on their first contract with the company to be assigned to the same ship; and
 - (iii) ensure all assigned crew hold seafarer documents issued by the ship's flag State that are valid for the position being filled.

2. It is recommended that KR:

- (a) undertake a review of the scantling and design approval requirements for ships with a high GM_0 to ensure the structure is adequate to withstand the associated high dynamic shear forces;
- (b) as deemed appropriate, revise its procedures for analyzing structural failures that are not the result of collisions or groundings that occur within five years of a ship being taken into class;
- (c) review and, as deemed appropriate, revise:
 - (i) its Rules for Steel Ships and related procedures for:
 - (1) reviewing and approving conversion designs to ensure material fatigue and any reductions in structural integrity that may have occurred while the ship was in service prior to the conversion are accounted for;
 - (2) verifying that for foreseeable damage conditions, that bulk carriers of 150 m or more in length of double-side skin construction designed to carry cargoes having a density of 1,000 kg/m³ have sufficient strength to withstand flooding of any space, or spaces, located between adjacent transverse bulkheads assuming that the transverse extent of the damage is equal to B/5 or 11.5 m, whichever is less, measured inboard from the side of the ship perpendicularly to the centerline at the level of summer load line in all loading and ballast conditions; and
 - (3) assessing structural damage to ensure that the cause of the failure is identified and that potential design defects are identified and corrected;
 - (ii) the procedures for verifying and enforcing compliance by ship managers with the Classification Society's reporting requirements; and
 - (iii) the procedures for ensuring full compliance with the reporting requirements of the current RO Agreement with the Administrator.

3. It is recommended that the Administrator:

- (a) review, and if deemed appropriate, revise its RO oversight procedures based on the lessons learned from this investigation;
- (b) review, and as deemed appropriate, further revise the vetting procedures for ships being considered for registration that have undergone a major conversion;

- (c) consider submitting a proposal to the IMO to amend SOLAS regulations XII/4 and 5 to require that for foreseeable damage conditions, bulk carriers of 150 m or more in length of double-side skin construction designed to carry cargoes having a density of 1,000 kg/m³ and above can withstand flooding of any space, or spaces, located between adjacent transverse bulkheads assuming that the transverse extent of the damage is equal to B/5 or 11.5 m, whichever is less, measured inboard from the side of the ship perpendicularly to the centerline at the level of summer load line in all loading and ballast conditions;
- (d) consider submitting a proposal to the IMO to amend the 2011 ESP Code to:
 - (i) align the schedule for inspections of bulk carrier WBTs with those for tankers;
 - (ii) require more frequent inspections of voids within the cargo length taking into consideration whether the void is coated and the condition of the coating; and
 - (iii) define the phrase “specially considered;”
- (e) consider submitting a proposal to the IMO to amend the IMSBC Code to require that testing of Grade A cargoes be conducted by independent third-party laboratories; and
- (f) consider submitting a proposal to the IMO to amend SOLAS chapter XII to require that bulk carriers carrying Grade A cargoes as defined by the IMSBC Code have sufficient stability and strength in an intact condition to withstand the liquefaction of a bulk solid cargo in one or more cargo holds.

The Administrator’s investigation is closed. It will be reopened if additional information is received that warrants further review.¹⁸⁶

¹⁸⁶ This includes information that might be recovered from STELLAR DAISY’s S-VDR and shared with the Administrator.